

2013

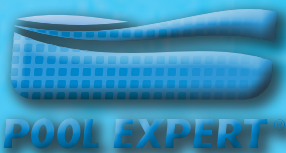



Índice Index Sommaire Indice

- Pag. 2 • **PRESENTACIÓN / PRESENTATION / PRÉSENTATION / PRESENTAZIONE**
 Pag. 4 • **NOVEDADES DE PRODUCTO / NEW PRODUCTS / NOUVEAUTÉS / NOVITÀ**
 Pag. 6 • **PISCINAS DE MADERA / WOODEN COVERING POOLS / PISCINES BOIS / PISCINE IN LEGNO**
 Pag. 8 • Serie Hawaii
 Pag. 10 • Serie Island
 Pag. 12 • **PISCINAS DE ACERO / STEEL WALL POOLS / PISCINES PAROI ACIER / PISCINE IN ACCIAIO**
 Pag. 14 • Serie Celosia
 Pag. 16 • Serie Mykonos - Skyathos
 Pag. 18 • Serie Iraklion
 Pag. 20 • Serie Amazonia - Mauritius
 Pag. 22 • Serie Pacific
 Pag. 24 • Serie Haiti - Atlantis
 Pag. 28 • Serie Fidji
 Pag. 30 • Serie Varadero - Bora Bora
 Pag. 31 • Serie Lanzarote - Tenerife - Formentera
 Pag. 32 • **JET POOL**
 Pag. 36 • **COMPLEMENTOS / COMPLEMENTS / COMPLÉMENTS / COMPLEMENTI**
 Pag. 38 • Cubiertas isotérmicas / Isothermic covers / Couvertures isothermes / Coperture isotermiche
 Pag. 39 • Cubiertas de invierno / Winter covers / Couvertures pour l'hiver / Copertura invernale
 Pag. 40 • Tapices de suelo / Floor tapestry / Tapis de sol / Tappeti da pavimento
 Pag. 41 • Mantas / Protective blanket / Couvertures de protection / Coperto di protezione fondi
 Pag. 42 • Liners / Liners / Fonds / Liners
 Pag. 43 • Kit reparación liner / Liner repair kit / Kit réparation liner / Kit riparazione liner
 Pag. 44 • Enrolladores de cubiertas / Telescopic cover rollers / Enrouleurs de bâches / Avvolgitore per piscine
 Pag. 45 • Escaleras / Ladders / Échelles / Scale
 Pag. 46 • Monoblocs de filtración / Filtration kit / Platine de filtration / Filtro monoblocco
 Pag. 48 • Filtros de arena / Sand filter/ Epurateur sable / Filtri sabbia
 Cargas filtrantes / Filter media / Charge filtrants / Carico filtrante
 Pag. 49 • Local técnico / Technical room / Local technique / Locale tecnico
 Skimmer
 Pag. 50 • Filtros de cartucho / Cartridge filter / Epurateur a cartouche / Filtri a cartuccia
 Cartuchos / Cartridges / Cartouches / Cartucce
 Pag. 51 • Bombas / Pumps / Pompes / Pompe
 Pag. 52 • Tratamiento de agua / Water treatment / Traitement d'eau / Trattamento acqua
 Pag. 53 • Iluminación / Lighting / Éclairage / Illuminazione
 Pag. 54 • Calefacción / Heating systems / Chauffage / Riscaldamento
 Pag. 55 • Calefacción solar / Solar heating system / Chauffage solaire / Riscaldamento solare
 Pag. 56 • Duchas / Showers / Douches / Docce
 Pag. 58 • Repuestos / Spare parts / Pièces de rechange / Parti
 Pag. 60 • **MATERIAL DE LIMPIEZA / CLEANING MATERIAL / MATÉRIEL DE NETTOYAGE / MATERIALE DI PULIZIA**
 Pag. 63 • Leyenda y formatos / Legend and formats / Légende et formats / Legenda e Formati
 Pag. 64 • Robots / Robots / Robots / Robots
 Pag. 66 • Limpiafondos automáticos / Automatic cleaners / Nettoyeurs automatiques / Puliscifondi automatici
 Pag. 68 • Kits limpiafondos de aspiración / Vacuum cleaners kits / Kit nettoyeur aspirante / Kit pulitore
 fondo ad aspirazione
 Pag. 70 • Limpiafondos ventury / Ventury vacuum / Aspirateurs de fond ventury / Puliscifondi Ventury
 Pag. 71 • Kits mantenimiento / Maintenance kits / Kits de nettoyage / Kit di mantenimento
 Pag. 72 • Gama Superluxe / Superluxe range / Gamme Superluxe / Gamma Superluxe
 Pag. 73 • Limpiafondos manuales / Vacuum heads / Balais manuels / Puliscifondo manuale
 Pag. 74 • Dosificadores / Dispensers / Doseurs / Dosatori
 Termómetros / Thermometers / Thermomètres / Termometri
 Pag. 75 • Mangos telescópicos / Telescopic handles / Manches télescopiques / Manico telescopico
 Pag. 76 • Cepillos / Brushes / Brosses / Spazzole
 Pag. 77 • Recogehojas / Leaf nets and rakes / Épuisettes / Raccoglitori
 Pag. 78 • Mangueras flotantes / Vacuum hoses / Tuyaux flottants / Tubi galleggiante
 Pag. 81 • Protección invierno / Winter protection / Protection hiver / Protezione inverno
 Pag. 82 • **PRODUCTOS QUÍMICOS / CHEMICALS / PRODUITS D'ENTRETIEN / PRODOTTI CHIMICI**
 Pag. 84 • Cuidado de su piscina / Take care of your swimming pool / Prendre soin de votre piscine / Indicazione per il trattamento della sua piscina
 Cálculo de volumen / Calculate the volume / Calcul de volume / Calcolo del volume d'acqua
 Pag. 86 • Producto Químico GRE / GRE chemicals / Produits d'entretien GRE / Chimica GRE
 Pag. 87 • Reguladores de pH / pH regulators / Régulateurs de pH / Correttori di pH
 Pag. 89 • Desinfectantes / Disinfectants / Désinfectants / Desinfettanti
 Cloro choque / Shock chlorine / Chlore choc / Cloro shock
 Cloro lento / Trichlorine / Chlore lent / Cloro lento
 Pag. 91 • Bromo / Bromine / Brome / Bromo
 Oxígeno activo / Active oxygen / Oxygène actif / Ossigeno
 Pag. 92 • Multifunciones / Multiactions / Multi-actions / Multi funzioni
 Pag. 94 • Tratamiento antialgas / Anti-algae treatment / Traitement anti-algues / Trattamento anti-alghe
 Pag. 95 • Floculante / Flocculant / Flocculant / Flocculante
 Pag. 96 • Productos complementarios / Complementary products / Produits complémentaires / Prodotti complementari
 Pag. 100 • Soluciones de tratamiento / Treatment solutions / Solutions de traitement / Trattamenti vari
 Pag. 102 • Analizadores / Test kits / Trousses d'analyse / Kit test
 Pag. 103 • Tiras de análisis / Test strips / Languettes d'analyse / Cartine tomasole



PRESENTACIÓN Y NOVEDADES
 PRESENTATION AND NEWS
 PRÉSENTATION ET NOUVEAUTÉS
 PRESENTAZIONE E NOVITÀ

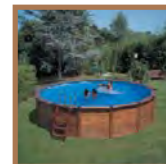

PISCINAS DE MADERA
 WOODEN COVERING POOLS
 PISCINES BOIS
 PISCINE IN LEGNO



PISCINAS DE ACERO
 STEEL WALL POOLS
 PISCINES PAROI ACIER
 PISCINE IN ACCIAIO



JET POOL



COMPLEMENTOS
 COMPLEMENTS
 COMPLÉMENTS
 COMPLEMENTI



MATERIAL DE LIMPIEZA
 CLEANING MATERIAL
 MATÉRIEL DE NETTOYAGE
 MATERIALE DI PULIZIA



PRODUCTO QUÍMICO
 CHEMICALS
 PRODUITS D'ENTRETIEN
 PRODOTTI CHIMICI

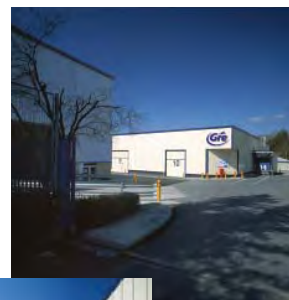

Presentación de la empresa

Gre es una empresa con más de 50 años de experiencia en la fabricación de piscinas elevadas.

Como empresa pionera en el sector, somos ESPECIALISTAS y LIDERES a nivel EUROPEO.

Nuestra apuesta clara por la CALIDAD y SEGURIDAD de todos nuestros productos , nos convierte en la REFERENCIA fundamental del mercado.

Nuestra empresa ofrece una AMPLIA GAMA de productos: piscinas elevadas de diferentes formatos y acabados, una completa línea de accesorios para su equipamiento y mantenimiento y una serie de productos químicos diseñados específicamente para el agua de la piscina.

Con el ánimo siempre, de satisfacer al cliente, Gre ha diseñado una estrategia de SERVICIOS, cuyo objetivo es ofrecer una solución integral. Nuestra amplia red de Servicios Técnicos, así como nuestros Departamentos de Atención al Cliente, son la mejor prueba de ello. Estos servicios nos permiten asesorarle sobre la opción de piscina y equipamiento más adecuados a sus necesidades.

La constante preocupación de Gre por la mejora en la calidad, por el medio ambiente y el reciclaje de todos sus envases y productos, le ha llevado a ser merecedor de las más importantes certificaciones: ISO 9001, ISO 14001, NF P 90-303, NF P 90-316 y NF P 90-317.

Company presentation

Gre is a company with more than 50 years experience in manufacturing above-ground pools.

As a pioneer company on its field, we are SPECIALISTS and LEADERS within the European market.

We are considered to be a fundamental market REFERENCE as a result of our clear wager on QUALITY and SECURITY of all our products.

Our company offers a WIDE RANGE of products which includes: different sizes and finishes above-ground pools, a complete range of accessories for their equipment and maintenance and a number of swimming pool chemicals designed specifically for the pool water.

Bearing in mind our customers satisfaction, Gre has designed an important SERVICES strategy whose aim is to offer an integral solution. Our wide network of Technical Services and our Customer Service Departments are the best proof of that. These services help us to identify our customers needs and to advice them on the best pool and equipment according to those needs.

Gre concern about quality improvement, environment and recycling of its packaging and products, has resulted in obtaining the most important certificates: ISO 9001, ISO 14001, NF P 90-303, NF P 90-316 and NF P 90-317.

Présentation de l'entreprise

Spécialisée dans la fabrication de piscines hors sol, Gre est une entreprise spécialisée dans la fabrication de piscines sur terrain.

Pionnière dans le secteur, notre entreprise est SPÉCIALISTE et LEADER en EUROPE.

Notre pari sur la QUALITÉ et la SÉCURITÉ de tous nos produits nous permet d'être la principale RÉFÉRENCE du marché.

Notre entreprise offre une LARGE GAMME de produits, allant des piscines surélevées aux tailles et finitions diverses et variées, jusqu'à un éventail complet des accessoires nécessaires à l'équipement et à l'entretien, et une gamme de produits chimiques conçus spécifiquement pour l'eau de la piscine.

Toujours dans le but de satisfaire le client, Gre a conçu une stratégie de SERVICES dont l'objectif est d'offrir une réponse et une solution complètes : un important réseau de Services Techniques ainsi qu'un Service Clients. Ces services nous permettent de vous conseiller sur le choix tant de votre piscine que de l'équipement le plus approprié à vos besoins.

La préoccupation constante de Gre pour l'amélioration de la qualité, l'environnement et le recyclage de tous ses emballages et produits lui a permis de mériter les normes les plus éminentes : ISO 9001, ISO 14001, NF P 90-303, NF P 90-316 y NF P 90-317.



Presentazione dell'azienda

La Gre è un'azienda con oltre 50 anni di esperienza nella produzione di piscine smontabili su terra.

Come impresa pioniera nel settore, siamo SPECIALISTI e LEADER a livello EUROPEO.

La nostra chiara scommessa sulla QUALITÀ e sulla SICUREZZA di tutti i nostri prodotti, fa di noi il RIFERIMENTO fondamentale del mercato.

La nostra società offre una VASTA GAMMA di prodotti: piscine elevate di diversi formati e finiture, una completa linea di accessori per l'attrezzatura e la manutenzione e una serie di prodotti chimici pensati specificamente per l'acqua della piscina.

Sempre con l'intenzione di soddisfare il cliente, la Gre ha progettato una strategia di SERVIZI il cui scopo è quello di offrire una soluzione integrale. La nostra vasta rete di Servizi Tecnici, così come i nostri Reparti di Servizio al Cliente, ne sono la miglior prova. Tali servizi ci consentono di dare consulenza sulla scelta della piscina e dell'equipaggiamento più idoneo alle vostre necessità.

Il costante impegno della Gre nel miglioramento della qualità, la sua preoccupazione nei confronti dell'ambiente e del riciclaggio di tutti gli imballaggi e prodotti, le hanno reso possibile la concessione dei più importanti certificati di qualità: ISO 9001, ISO 14001, NF P 90-303, NF P 90-316 y NF P 90-317.

Novedades de producto New products

Piscinas Pools Piscines Piscine



Recambios Spares
Pièces de rechange
Pezzi di ricambio



Escalera Ladder
Échelle Scale



Vidrio filtrante Glass filter media
Verre filtrant Vetro filtrante



Electrolisis de sal Salt chlorinator
Electrolyseur au sel Elettrolisi salina

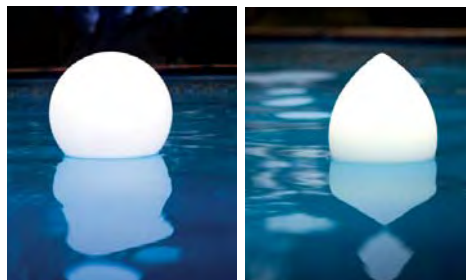

Iluminación Lighting
Éclairage Illuminazione



Ducha Shower
Douche Docce

s Nouveautés Novità

Calefacción solar Solar heating system
Chauffage solaire Riscaldamento solare



Robots Robots Robots Robots



Gama Superluxe Superluxe range
Gamme Superluxe Gamma superluxe



Material de limpeza Cleaning material
Matériel de nettoyage Materiale de pulizia



Producto Químico Chemicals Produits d'entretien Prodotti chimici



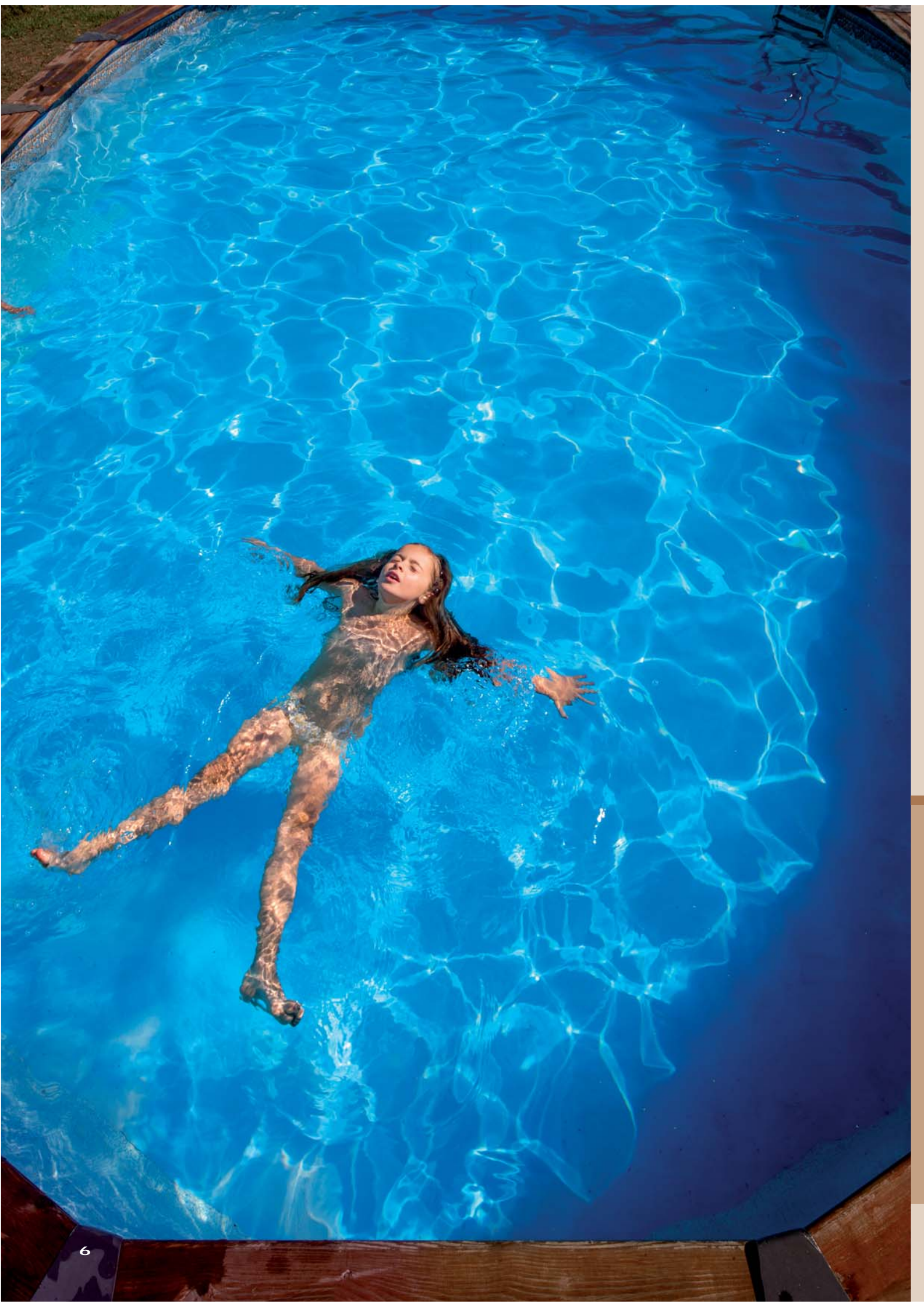

NATURE POOL

PISCINA DE PARED DE ACERO CON REVESTIMIENTO DE MADERA

- LINER:** TRATAMIENTO ANTI - ULTRAVIOLETA - RETRASA EL ENVEJECIMIENTO DEL P.V.C.
CHAPA: LAMINADA EN FRIO CON TRATAMIENTO DE GALVANIZACIÓN, FOSFATACIÓN E IMPRIMACIÓN. PERFILACIÓN VERTICAL DE LA MISMA PARA LA OBTENCIÓN DE UNA MAYOR RESISTENCIA. TROQUELADA PARA SKIMMER Y VÁLVULA DE RETORNO DEL AGUA.
MADERA: MADERA DE PINO NÓRDICO , CON TRATAMIENTO NIVEL IV CLASE V , SEGÚN NORMA EUROPEA EN-335. TROQUELADA PARA SKIMMER Y VÁLVULA DE RETORNO DEL AGUA.

STEEL WALL POOL WITH WOODEN COVERING

- LINER:** ANTI-ULTRAVIOLET TREATMENT TO SLOW DOWN P.V.C AGING.
PLATE: GALVANIZED, PHOSPHATIZED, PRIMED AND LACQUERED COLD-ROLLED PLATE. VERTICAL SECTIONING FOR AN INCREASED STRENGTH. DIE CUT FOR SKIMMER AND WATER RETURN VALVE OPENINGS.
WOOD: NORDIC PINE WOOD WITH LEVEL IV TREATMENT ACCORDING TO EN-335 EUROPEAN STANDARD.

PISCINE BOIS DOUBLE PAROI

- LINER:** TRAITEMENT ANTI-ULTRAVIOLETS CONTRE LE VIEILLISSEMENT DU P.V.C.
TÔLE: TÔLE LAMINÉE À FROID ET TRAITÉE PAR GALVANISATION, PHOSPHATAGE, COUCHE D'APPRÊT ET LAQUAGE. PROFILÉS VERTICAUX POUR UNE MEILLEURE RÉSISTANCE. DÉCOUPAGE POUR LE SKIMMER ET LA VANNE ANTI-REFOULEMENT D'EAU.
BOIS: PIN NORDIQUE , AVEC TRAITEMENT DE NIVEAU IV , SELON LA NORME EUROPÉENNE ; EN-335.

PISCINA CON RIVESTIMENTO IN LEGNO

- LINER:** TRATTAMENTO ANTI-ULTRAVIOLETTI – RITARDA L'INVECCHIAMENTO DEL P.V.C.
PANNELLO: LAMINATA A FREDDO CON TRATTAMENTO DI GALVANIZZAZIONE, FOSFATAZIONE E PREPARAZIONE. PREPARAZIONE VERTICALE PER OTTENERE UNA MAGGIORE RESISTENZA. STAMPIGLIATURA PER SKIMMER E VALVOLA DI RETORNO DELL'ACQUA.
LEGNO: LEGNO DI PINO NORDICO, CON TRATTAMENTO LIVELLO IV CLASSE V, SECONDO NORMATIVA EUROPEA EN-335. PREPARAZIONE PER SKIMMER E VALVOLA DI RETORNO DELL'ACQUA.



NATURE POOL



- Liner cenefa 50/100
- Tapas metal lacado
- Perfilaría de madera
- Frieze liner 50/100
- Lacquered metal covers
- Wooden frames
- Liner frise 50/100
- Cache-margelles métalliques
- Poteaux et margelles en bois
- Liner cenefa 50/100
- Copertura metallica laccata
- Bordi di legno

- Depuradora arena
 - Caudal grupo 8,7 y 5 m
- Escalera:
 - Madera / acero inoxidable
- Manta protectora
 - Poliéster
- Limpiafondos automático



Tinte Woodstainer
Teinture Verniciatura



DVD
VIDEO



- KITNPOV911**
- KITNPOV811**
- KITNPOV731**
- KITNPOV611**



NPOV911

Sistema de Omegas **Omega system** Renforts ent



NP461

- Depuradora arena
 - Silex 5 m³/h
- Escalera:
 - Madera / acero
- Manta protectora
 - Poliéster
- Limpiafondos auto

KITNP461

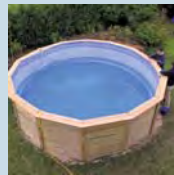

SERIE HAWAII

- Sand filter
- Flow group 8, 7 and 5 m³/h
- Ladder:
- Bois / stainless steel
- Bottom protective blanket
- Polyester
- Automatic pool cleaner
- Epurateur sable
- Débit groupe 8, 7 et 5 m³/h
- Echelle:
- Bois / acier inoxydable
- Tapis de sol en feutre
- Polyester
- Aspirateur automatique
- Filtro a sabbia
- Caudale gruppo 8, 7 e 5 m³/h
- Scale:
- Legno / acciaio inox
- Coperte di protezione
- Poliestere
- Pulisci-fondo automatico



930x515 cm	132 cm	43.580 l	597/640 kg	1/120x80 - 1/134x116	8m³/h	✓	✓	28	22	227702
820x515 cm	132 cm	37.550 l	587/580 kg	1/120x80 - 1/134x116	7m³/h	✓	✓	28	22	227719
750x425 cm	132 cm	28.050 l	497/498 kg	1/120x80 - 1/134x116	7m³/h	✓	✓	28	19,5/22	227726
640x425 cm	132 cm	23.230 l	411/421 kg	1/120x80 - 1/134x116	7m³/h	✓	✓	28	19,5/22	227733

ts enterrées Sistema omega



- Sand filter
- Sílex 5 m³/h
- Ladder:
- Bois / stainless steel
- Bottom protective blanket
- Polyester
- Automatic pool cleaner
- Epurateur sable
- Sílex 5 m³/h
- Echelle:
- Bois / acier inoxydable
- Tapis de sol en feutre
- Polyester
- Aspirateur automatique
- Filtro a sabbia
- Sílex 5 m³/h
- Scale:
- Legno / acciaio inox
- Coperte di protezione
- Poliestere
- Pulisci-fondo automatico

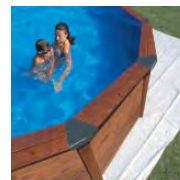
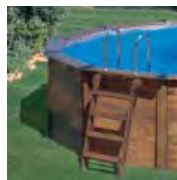

Ø500 cm	132 cm	20.270 l	217/385 kg	1/90x80 - 1/134x116	5m³/h	✓	✓	28	19,5	227764
---------	--------	----------	------------	---------------------	-------	---	---	----	------	--------



	Medida piscina Pool size Dimensions piscine Misura piscina cm	Espacio necesario Necessary space Espace nécessaire Spazio necessario cm
KITNPOV911	930x515	950x550
KITNPOV811	820x515	900x550
KITNPOV731	750x425	800x450
KITNPOV611	640x425	700x450



	Medida piscina Pool size Dimensions piscine Misura piscina cm	Espacio necesario Necessary space Espace nécessaire Spazio necessario cm
KITNP461	Ø 500	510x510

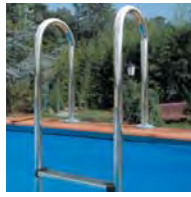

- Liner azul 40/100
- Tapas metal lacado
- Perfilera de madera
- Blue liner 40/100
- Lacquered metal covers
- Wooden frames
- Liner frise 40/100
- Cache-margelles métalliques
- Poteaux et margelles en bois
- Liner blu 40/100
- Copertura metallica laccata
- Bordi di legno

- Depuradora arena
 - Caudal grupo 5, 4, 3 m³/h
- Escalera:
 - Madera / acero inoxidable
- Tapiz de suelo
 - Polietileno 115 g/m²



Tinte Woodstainer
Teinture Verniciatura



DVD
VIDEO



NPOV612

KITNPOV732
KITNPOV612
KITNPOV502

Sistema de Omegas **Omega system** Renforts ent



NP352A

- KITNP352(A) - KITNP242(A)
- Liner azul 30/100
- KITNP352(A) - KITNP242(A)
- Blue liner 30/100
- KITNP352(A) - KITNP242(A)
- Liner frise 30/100
- KITNP352(A) - KITNP242(A)
- Liner blu 30/100

- Depuradora arena
 - Caudal grupo 3 m³/h
- Filtro cartucho 3,8 m³/h
- Escalera:
 - Madera / acero inoxidable
- Tapiz de suelo
 - Polietileno 115 g/m²

KITNP462
KITNP352A
KITNP242A
KITNP352
KITNP242

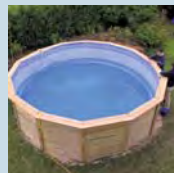

- Sand filter
 - Flow group 5, 4 and 3 m³/h
- Ladder:
 - Bois / stainless steel
- Floor tapestry
 - Polythene 115 g/m²

- Epurateur sable
 - Débit groupe 5, 4 et 3 m³/h
- Échelle:
 - Bois / acier inoxydable
- Tapis de sol
 - Polyéthylène 115 g/m²

- Filtro a sabbia
 - Caudale gruppo 5, 4 e 3 m³/h
- Scale:
 - Legno / acciaio inox
- Telo di protezione
 - Polietilene 115 g/m²

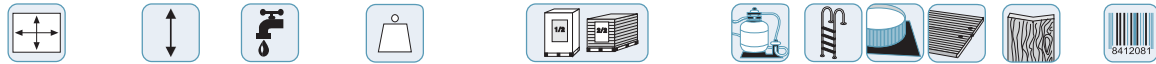

745x420 cm	120 cm	25.180 l	482/404 kg	1/90x80 - 1/124x116	5m ³ /h	✓	✓	24	19,5/22	224923
635x420 cm	120 cm	20.890 l	378/366 kg	1/90x80 - 1/124x116	4m ³ /h	✓	✓	24	19,5/22	220093
535x345 cm	120 cm	14.000 l	352/356 kg	1/90x80 - 1/124x116	3m ³ /h	✓	✓	24	14,5/22	220109

ts enterrées Sistema omega

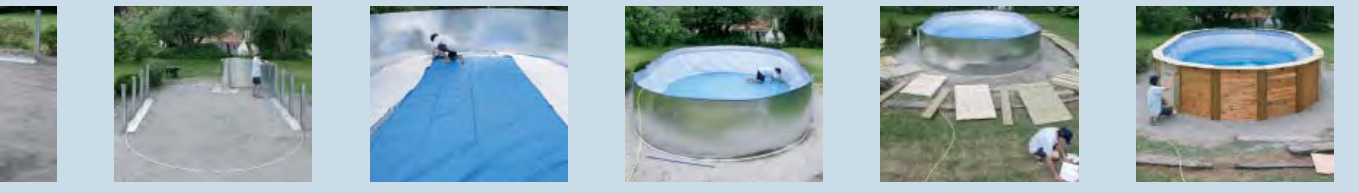

- Sand filter
 - Flow group 3 m³/h
- Cartridge filter 3,8m³/h
- Ladder:
 - Bois / stainless steel
- Floor tapestry
 - Polythene 115 g/m²

- Epurateur sable
 - Débit groupe 3 m³/h
- Epurateur a cartouche 3,8 m³/h
- Échelle:
 - Bois / acier inoxydable
- Tapis de sol
 - Polyéthylène 115 g/m²

- Filtro a sabbia
 - Caudale gruppo 3 m³/h
- Depuratore a cartuccia 3,8 m³/h
- Scale:
 - Legno / acciaio inox
- Telo di protezione
 - Polietilene 115 g/m²



Ø490 cm	120 cm	17.450 l	199/337 kg	1/80x60 - 1/124x116	3m ³ /h	-	✓	✓	24	19,5	220123
Ø390 cm	120 cm	10.102 l	185/221 kg	1/80x60 - 1/124x116	3m ³ /h	-	✓	✓	24	14,5	224930
Ø280 cm	120 cm	4.750 l	159/219 kg	1/80x60 - 1/124x94,5	3m ³ /h	-	✓	✓	24	14,5	230924
Ø390 cm	120 cm	10.102 l	176/221 kg	1/80x40 - 1/124x116	- 3,8m ³ /h	✓	✓	24	14,5	220130	
Ø280 cm	120 cm	4.750 l	151/219 kg	1/80x40 - 1/124x94,5	- 3,8m ³ /h	✓	✓	24	14,5	230917	



Medida piscina
Pool size
Dimensions piscine
Misura piscina
cm

KITNPOV732	745x420	800x450
KITNPOV612	635x420	700x450
KITNPOV502	535x345	600x375



Medida piscina
Pool size
Dimensions piscine
Misura piscina
cm

KITNP462	Ø 490	510x510
KITNP352/KITNP352A	Ø 390	410x410
KITNP242/KITNP242A	Ø 280	300x300



DREAM POOL

PISCINA DE PARED DE ACERO

- LINER:** TRATAMIENTO ANTI - ULTRAVIOLETA - RETRASA EL ENVEJECIMIENTO DEL P.V.C.
CHAPA: LAMINADA EN FRÍO CON TRATAMIENTO DE GALVANIZACIÓN, FOSFATACIÓN, IMPRIMACIÓN Y LACADO. PERFILACIÓN VERTICAL DE LA MISMA PARA LA OBTENCIÓN DE UNA MAYOR RESISTENCIA. TROQUELADA PARA SKIMMER Y VÁLVULA DE RETORNO DEL AGUA.
PERFILES: DE ACERO Y DE P.V.C.

STEEL WALL POOL

- LINER:** ANTI-ULTRAVIOLET TREATMENT TO SLOW DOWN P.V.C AGING.
PLATE: GALVANIZED, PHOSPHATIZED, PRIMED AND LACQUERED COLD-ROLLED PLATE. VERTICAL SECTIONING FOR AN INCREASED STRENGTH. DIE CUT FOR SKIMMER AND WATER RETURN VALVE OPENINGS.
PROFILES: METAL OR P.V.C

PISCINE PAROI ACIER

- LINER:** TRAITEMENT ANTI-ULTRAVIOLETS CONTRE LE VIEILLISSEMENT DU P.V.C.
TÔLE: TÔLE LAMINÉE À FROID ET TRAITÉE PAR GALVANISATION, PHOSPHATAGE, COUCHE D'APPRÊT ET LAQUAGE. PROFILÉS VERTICAUX POUR UNE MEILLEURE RÉSISTANCE. DÉCOUPAGE POUR LE SKIMMER ET LA VANNE ANTI-REFOULEMENT D'EAU.
PROFILES: MÉTALLIQUES OU EN P.V.C.

PISCINA CON PARETI IN ACCIAIO

- LINER:** TRATAMIENTO ANTI - ULTRAVIOLETA - RETRASA EL ENVEJECIMIENTO DEL P.V.C.
PANELLO: LAMINATO A FREDDO CON TRATTAMENTO DI GALVANIZZAZIONE, FOSFATAZIONE, PREPARAZIONE E LACCAGGIO. PREPARAZIONE VERTICALE DELLA STESSA PER OTTENERE UNA MAGGIORE RESISTENZA. STAMPIGLIATURA PER SKIMMER E VALVOLA DI RITORNO DELL'ACQUA.
PROFILI: ACCIAIO E P.V.C.



DREAM POOL



- Liner PVC azul 40/100
- Periferia acero
- Protectores inyección
- PVC blue liner 40/100
- Steel profiles
- Injection saver
- Liner PVC couleur bleu 40/100
- Poteaux et margelles acier
- Protections moulées par injection
- Liner PVC blu 40/100
- Profili in acciaio
- Angolare di protezione

- Depuradora arena
 - Caudal grupo 5 m³/h
- Escalera de seguridad
 - Plataforma +2x3 Peldaños
- Tapiz de suelo
 - Polietileno 115 g/m²



PROV738C

KITPROV738C

KITPROV618C



PR558C

KITPR558C

KITPR458C



	Medida piscina Pool size Dimensions piscine Misura piscina cm	Espacio necesario Necessary space Espace necessaire Spazio necessario cm
KITPROV738C	730x375	770x595
KITPROV618C	610x375	650x595

SERIE CELOSIA

- Sand filter
 - Flow group 5 m³/h
- Safety Ladder
 - Platform + 2x3 Steps
- Floor tapestry
 - Polythene 115 g/m²
- Epurateur sable
 - Débit groupe 5 m³/h
- Échelle sécurité
 - Plateforme + 2x3 Marches
- Tapis de sol
 - Polyéthylène 115 g/m²
- Filtro a sabbia
 - Caudale gruppo 5 m³/h
- Scala di sicurezza:
 - Piattaforma + 2x3 Gradini
- Telo di protezione
 - Polietilene 115 g/m²



730x375 cm	132 cm	28.217 l	335 kg	1/120x80	5m ³ /h	√	√	15	12	241661
610x375 cm	132 cm	23.281 l	270 kg	1/90x80	5m ³ /h	√	√	15	12	241678



Ø 550 cm	132 cm	27.798 l	243 kg	1/90x80	5m ³ /h	√	√	15	12	241685
Ø 460 cm	132 cm	19.444 l	238 kg	1/90x80	5m ³ /h	√	√	15	12	241692



KITPR558C

KITPR458C

Medida piscina
Pool size
Dimensions piscine
Misura piscina
cm

550 ø

460 ø

Espacio necesario
Necessary space
Espace nécessaire
Spazio necessario
cm

600x600

500x500

DREAM POOL



- Liner PVC arena 40/100
- Periferia acero
- Protectores inyección
- PVC sand liner 40/100
- Steel profiles
- Injection saver
- Liner PVC couleur sable 40/100
- Poteaux et margelles acier
- Protections moulées par injection
- Liner PVC sabbia 40/100
- Profili in acciaio
- Angolare di protezione

- Depuradora arena
 - Caudal grupo 8, 7 y 5 m²/h
- Escalera de seguridad
 - Plataforma +2x3 Peldaños
- Tapiz de suelo
 - Polietileno 115 g/m²



PROV9188P

KITPROV9188P

KITPROV7388P

KITPROV6188P



Sistema de Omegas
Omega system
 Renforts enterrées
 Sistema Omega



PROV918P

KITPROV918P

KITPROV818P

KITPROV738P

KITPROV618P



PR558P

KITPR558P

KITPR458P

KITPR358P



SERIE MYKONOS

- Sand filter
- Epurateur sable
- Filtro a sabbia
- Flow group 8, 7 and 5 m³/h
- Débit groupe 8, 7 et 5 m³/h
- Caudale gruppo 8, 7 e 5 m³/h
- Safety Ladder
- Échelle sécurité
- Scala di sicurezza:
- Platform + 2x3 Steps
- Plateforme + 2x3 Marches
- Piattaforma + 2x3 Gradini
- Floor tapestry
- Tapis de sol
- Telo di protezione
- Polythene 115 g/m²
- Polyéthylène 115 g/m²
- Polietilene 115 g/m²

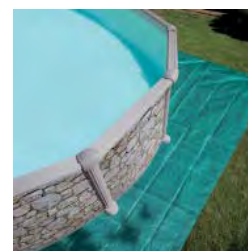

915x470 cm	132 cm	43.595 l	602 kg	1/120x80	8m ³ /h	✓	✓	15	12	230832
730x375 cm	132 cm	28.217 l	462 kg	1/120x80	5m ³ /h	✓	✓	15	12	230849
610x375 cm	132 cm	23.281 l	437 kg	1/90x80	5m ³ /h	✓	✓	15	12	230856



	Medida piscina Pool size Dimensions piscine Misura piscina cm	Espacio necesario Necessary space Espace necessaire Spazio necessario cm
KITPROV9188P	915x470	955x590
KITPROV7388P	730x375	770x495
KITPROV6188P	610x375	650x495

SERIE SKYATHOS



915x470 cm	132 cm	43.595 l	480 kg	1/120x80	8m ³ /h	✓	✓	15	12	230863
800x470 cm	132 cm	37.474 l	428 kg	1/120x80	7m ³ /h	✓	✓	15	12	233406
730x375 cm	132 cm	28.217 l	335 kg	1/120x80	5m ³ /h	✓	✓	15	12	230870
610x375 cm	132 cm	23.281 l	270 kg	1/90x80	5m ³ /h	✓	✓	15	12	230887
Ø 550 cm	132 cm	27.798 l	243 kg	1/90x80	5m ³ /h	✓	✓	15	12	230894
Ø 460 cm	132 cm	19.444 l	238 kg	1/90x80	5m ³ /h	✓	✓	15	12	230900
Ø 350 cm	132 cm	11.250 l	184 kg	1/90x80	5m ³ /h	✓	✓	15	12	233888



	Medida piscina Pool size Dimensions piscine Misura piscina cm	Espacio necesario Necessary space Espace necessaire Spazio necessario cm
KITPROV918P	915x470	955x690
KITPROV818P	800x470	850x690
KITPROV738P	730x375	770x595
KITPROV618P	610x375	650x595



	Medida piscina Pool size Dimensions piscine Misura piscina cm	Espacio necesario Necessary space Espace necessaire Spazio necessario cm
KITPR558P	550 Ø	600x600
KITPR458P	460 Ø	500x500
KITPR358P	350 Ø	400x400

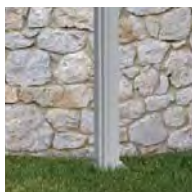
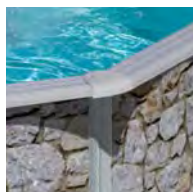
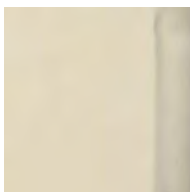

- Liner PVC arena 30/100 (KIT730P-KIT610P: 40/100)
- Periferia acero
- Protectores inyección
- PVC sand liner 30/100 (KIT730W-KIT610W: 40/100)
- Steel profiles
- Injection saver
- Liner PVC couleur sable 30/100 (KIT730W-KIT610W: 40/100)
- Poteaux et margelles acier
- Protections moulées par injection
- Liner PVC sabbia 30/100 (KIT730W-KIT610W: 40/100)
- Profili in acciaio
- Angolare di protezione



730P

KIT730P
KIT610P
KIT500P



460P

KIT460P
KIT350P
KIT240P



- | | | | |
|--|---|--|---|
| • Depuradora arena
- Caudal grupo 4 y 3 m ³ /h | • Sand filter
- Flow group 4 and 3 m ³ /h | • Epurateur sable
- Débit groupe 4 et 3 m ³ /h | • Filtro a sabbia
- Caudale gruppo 4 e 3 m ³ /h |
| • Escalera de seguridad
- 2x3 Peldaños | • Safety Ladder
- 2x3 Steps | • Échelle sécurité
- 2x3 Marches | • Scala di sicurezza:
- 2x3 Gradini |



730x375 cm	120 cm	25.323 l	287 kg	1/90x80	4m ³ /h	✓	15	12	237558
610x375 cm	120 cm	20.893 l	235 kg	1/80x60	3m ³ /h	✓	15	12	233581
500x300 cm	120 cm	14.550 l	224 kg	1/80x60	3m ³ /h	✓	15	12	233598

Ø 460 cm	120 cm	17.450 l	172 kg	1/80x60	3m ³ /h	✓	15	12	233376
Ø 350 cm	120 cm	10.102 l	146 kg	1/80x60	3m ³ /h	✓	15	12	233611
Ø 240 cm	120 cm	4.750 l	126 kg	1/80x60	3m ³ /h	✓	15	12	237718



	Medida piscina Pool size Dimensions piscine Misura piscina cm	Espacio necesario Necessary space Espace necessaire Spazio necessario cm
KIT730P	730x375	770x595
KIT610P	610x375	650x595
KIT500P	500x300	540x520



	Medida piscina Pool size Dimensions piscine Misura piscina cm	Espacio necesario Necessary space Espace necessaire Spazio necessario cm
KIT460P	460 Ø	500x500
KIT350P	350 Ø	400x400
KIT240P	240 Ø	300x300

DREAM POOL



- Liner PVC arena 40/100
- Periferia acero
- Protectores inyección
- PVC sand liner 40/100
- Steel profiles
- Injection saver
- Liner PVC couleur sable 40/100
- Poteaux et margelles acier
- Protections moulées par injection
- Liner PVC sabbia 40/100
- Profili in acciaio
- Angolare di protezione

- Depuradora arena
 - Caudal grupo 8, 7 y 5 m³/h
- Escalera de seguridad
 - Plataforma +2x3 Peldaños
- Tapiz de suelo
 - Polietileno 115 g/m²



PROV9188W

KITPROV9188W
KITPROV7388W
KITPROV6188W



Sistema de Omegas
Omega system
 Renforts enterrés
 Sistema Omega



PROV918W

KITPROV918W
KITPROV818W
KITPROV738W
KITPROV618W



PR558W

KITPR558W
KITPR458W
KITPR358W



SERIE AMAZONIA

- Sand filter
- Safety Ladder
- Floor tapestry
- Epurateur sable
- Échelle sécurité
- Plateforme + 2x3 Marches
- Tapis de sol
- Filtro a sabbia
- Caudale gruppo 8,7 e 5 m³/h
- Scala di sicurezza:
- Piattaforma + 2x3 Gradini
- Telo di protezione
- Polietilene 115 g/m²

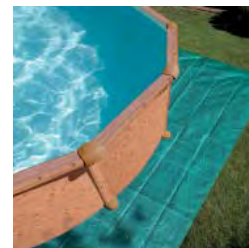

915x470 cm	132 cm	43.595 l	602 kg	1/120x80	8m ³ /h	√	√	15	12	227429
730x375 cm	132 cm	28.217 l	462 kg	1/120x80	5m ³ /h	√	√	15	12	227436
610x375 cm	132 cm	23.281 l	437 kg	1/90x80	5m ³ /h	√	√	15	12	227443



	Medida piscina Pool size Dimensions piscine Misura piscina cm	Espacio necesario Necessary space Espace necessaire Spazio necessario cm
KITPROV9188W	915x470	955x590
KITPROV7388W	730x375	770x495
KITPROV6188W	610x375	650x495

SERIE MAURITIUS



915x470 cm	132 cm	43.595 l	480 kg	1/120x80	8m ³ /h	√	√	15	12	227627
800x470 cm	132 cm	37.474 l	428 kg	1/120x80	7m ³ /h	√	√	15	12	233390
730x375 cm	132 cm	28.217 l	335 kg	1/120x80	5m ³ /h	√	√	15	12	227634
610x375 cm	132 cm	23.281 l	270 kg	1/90x80	5m ³ /h	√	√	15	12	227641
Ø 550 cm	132 cm	27.798 l	243 kg	1/90x80	5m ³ /h	√	√	15	12	227450
Ø 460 cm	132 cm	19.444 l	238 kg	1/90x80	5m ³ /h	√	√	15	12	227467
Ø 350 cm	132 cm	11.250 l	184 kg	1/90x80	5m ³ /h	√	√	15	12	233871



	Medida piscina Pool size Dimensions piscine Misura piscina cm	Espacio necesario Necessary space Espace necessaire Spazio necessario cm
KITPROV918W	915x470	955x690
KITPROV818W	800x470	850x690
KITPROV738W	730x375	770x595
KITPROV618W	610x375	650x595



	Medida piscina Pool size Dimensions piscine Misura piscina cm	Espacio necesario Necessary space Espace necessaire Spazio necessario cm
KITPR558W	550 Ø	600x600
KITPR458W	460 Ø	500x500
KITPR358W	350 Ø	400x400

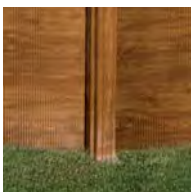
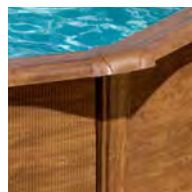
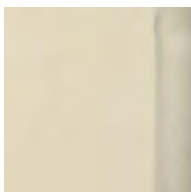

- Liner PVC arena 30/100 (KIT730W-KIT610W: 40/100)
- Perfileira acero
- Protectores inyección
- PVC sand liner 30/100 (KIT730W-KIT610W: 40/100)
- Steel profiles
- Injection saver
- Liner PVC couleur sable 30/100 (KIT730W-KIT610W: 40/100)
- Poteaux et margelles acier
- Protections moulées par injection
- Liner PVC sabbia 30/100 (KIT730W-KIT610W: 40/100)
- Profili in acciaio
- Angolare di protezione



730W

KIT730W
KIT610W
KIT500W













460W











KIT460W
KIT350W
KIT240W



- Depuradora arena
 - Caudal grupo 4 y 3 m³/h
- Escalera de seguridad
 - 2x3 Peldaños
- Sand filter
 - Flow group 4 and 3 m³/h
- Safety Ladder
 - 2x3 Steps
- Epurateur sable
 - Débit groupe 4 et 3 m³/h
- Échelle sécurité
 - 2x3 Marches
- Filtro a sabbia
 - Caudale gruppo 4 e 3 m³/h
- Scala di sicurezza:
 - 2x3 Gradini



									
730x375 cm	120 cm	25.323 l	287 kg	1/90x80	4m ³ /h	√	15	12	232249
610x375 cm	120 cm	20.893 l	235 kg	1/80x60	3m ³ /h	√	15	12	225104
500x300 cm	120 cm	14.550 l	224 kg	1/80x60	3m ³ /h	√	15	12	231068

									
Ø 460 cm	120 cm	17.450 l	172 kg	1/80x60	3m ³ /h	√	15	12	225111
Ø 350 cm	120 cm	10.102 l	146 kg	1/80x60	3m ³ /h	√	15	12	225722
Ø 240 cm	120 cm	4.750 l	126 kg	1/80x60	3m ³ /h	√	15	12	226163



	Medida piscina Pool size Dimensions piscine Misura piscina cm	Espacio necesario Necessary space Espace necessaire Spazio necessario cm
KIT730W	730x375	770x595
KIT610W	610x375	650x595
KIT500W	500x300	540x520



	Medida piscina Pool size Dimensions piscine Misura piscina cm	Espacio necesario Necessary space Espace necessaire Spazio necessario cm
KIT460W	460 Ø	500x500
KIT350W	350 Ø	400x400
KIT240W	240 Ø	300x300

DREAM POOL

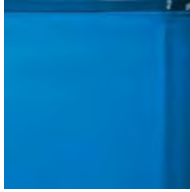

- Liner PVC azul 40/100
- Periferia acero
- Protectores inyección
- PVC blue liner 40/100
- Steel profiles
- Injection saver
- Liner PVC couleur bleu 40/100
- Poteaux et margelles acier
- Protections moulées par injection
- Liner PVC blu 40/100
- Profili in acciaio
- Angolare di protezione

- Depuradora arena
- Caudal grupo 10 , 8,7 y 5 m³/h
- Escalera de seguridad
- Plataforma +2x3 Peldaños
- Tapiz de suelo
- Polietileno 115 g/m²



PROV9188

KITPROV10288

KITPROV9188

KITPROV8188

KITPROV7388

KITPROV6188



Sistema de Omegas
Omega system
 Renforts enterrés
 Sistema Omega



PROV918

KITPROV1028

KITPROV918

KITPROV818

KITPROV738

KITPROV618



PR558

KITPR558

KITPR458

KITPR358



SERIE HAITI

- Sand filter
- Epurateur sable
- Filtro a sabbia
- Flowgroup 10,8,7 and 5m³/h
- Débit groupe 10,8,7 et 5 m³/h
- Caudale gruppo 10,8,7 e 5 m³/h
- Safety Ladder
- Échelle sécurité
- Scala di sicurezza:
- Platform + 2x3 Steps
- Plateforme + 2x3 Marches
- Piattaforma + 2x3 Gradini
- Floor tapestry
- Tapis de sol
- Telo di protezione
- Polythene 115 g/m²
- Polyéthylène 115 g/m²
- Polietilene 115 g/m²



Icon	Icon	Icon	Icon	Icon	Icon	Icon	Icon	Icon	Icon	Icon	Icon
1000x550 cm	132 cm	56.111 l	620 kg	1/120x100	10m ³ /h	✓	✓	15	12	224626	
915x470 cm	132 cm	43.595 l	602 kg	1/120x80	8m ³ /h	✓	✓	15	12	220215	
800x470 cm	132 cm	37.474 l	482 kg	1/120x80	7m ³ /h	✓	✓	15	12	224633	
730x375 cm	132 cm	28.217 l	462 kg	1/120x80	5m ³ /h	✓	✓	15	12	220222	
610x375 cm	132 cm	23.281 l	437 kg	1/90x80	5m ³ /h	✓	✓	15	12	221328	



	Medida piscina Pool size Dimensions piscine Misura piscina cm	Espacio necesario Necessary space Espace necessaire Spazio necessario cm
KITPROV10288	1000x550	1040x670
KITPROV9188	915x470	955x590
KITPROV8188	800x470	850x590
KITPROV7388	730x375	770x495
KITPROV6188	610x375	650x495

SERIE ATLANTIS

Icon	Icon	Icon	Icon	Icon	Icon	Icon	Icon	Icon	Icon	Icon
1000x550 cm	132 cm	56.111 l	498 kg	1/120x80	10m ³ /h	✓	✓	15	12	220239
915x470 cm	132 cm	43.595 l	480 kg	1/120x80	8m ³ /h	✓	✓	15	12	211978
800x470 cm	132 cm	37.474 l	428 kg	1/120x80	7m ³ /h	✓	✓	15	12	211565
730x375 cm	132 cm	28.217 l	335 kg	1/120x80	5m ³ /h	✓	✓	15	12	211985
610x375 cm	132 cm	23.281 l	270 kg	1/90x80	5m ³ /h	✓	✓	15	12	211572
Ø 550 cm	132 cm	27.798 l	243 kg	1/90x80	5m ³ /h	✓	✓	15	12	211589
Ø 460 cm	132 cm	19.444 l	238 kg	1/90x80	5m ³ /h	✓	✓	15	12	211596
Ø 350 cm	132 cm	11.250 l	184 kg	1/90x80	5m ³ /h	✓	✓	15	12	233864



	Medida piscina Pool size Dimensions piscine Misura piscina cm	Espacio necesario Necessary space Espace necessaire Spazio necessario cm
KITPROV1028	1000x550	1040x770
KITPROV918	915x470	955x690
KITPROV818	800x470	850x690
KITPROV738	730x375	770x595
KITPROV618	610x375	650x595



	Medida piscina Pool size Dimensions piscine Misura piscina cm	Espacio necesario Necessary space Espace necessaire Spazio necessario cm
KITPR558	550 Ø	600x600
KITPR458	460 Ø	500x500
KITPR358	350 Ø	400x400



- Liner azul 30/100 (KIT730ECO - KIT610ECO: 40/100)
- Perfilería acero
- Protectores inyección
- PVC blue liner 30/100 (KIT730ECO - KIT610ECO: 40/100)
- Steel profiles
- Injection saver
- Liner PVC couleur bleu 30/100 (KIT730ECO - KIT610ECO: 40/100)
- Poteaux et margelles acier
- Protections moulées par injection
- Liner PVC blu 30/100 (KIT730ECO - KIT610ECO: 40/100)
- Profili in acciaio
- Angolare di protezione



730ECO

KIT730ECO
KIT610ECO
KIT500ECO













460ECO



KIT550ECO
KIT460ECO
KIT350ECO
KIT300ECO
KIT240ECO



- Depuradora arena
 - Caudal grupo 4 y 3 m³/h
- Escalera de seguridad
 - 2x3 Peldaños
- Sand filter
 - Flow group 4 and 3 m³/h
- Safety Ladder
 - 2x3 Steps
- Epurateur sable
 - Débit groupe 4 et 3 m³/h
- Échelle sécurité
 - 2x3 Marches
- Filtro a sabbia
 - Caudale gruppo 4 e 3 m³/h
- Scala di sicurezza:
 - 2x3 Gradini



									
730x375 cm	120 cm	25.323 l	287 kg	1/90x80	4m ³ /h	√	15	12	211398
610x375 cm	120 cm	20.893 l	234 kg	1/80x60	3m ³ /h	√	15	12	211404
500x300 cm	120 cm	14.550 l	224 kg	1/80x60	3m ³ /h	√	15	12	231037

									
Ø 550 cm	120 cm	24.944 l	209 kg	1/80x60	4m ³ /h	√	15	12	211411
Ø 460 cm	120 cm	17.450 l	172 kg	1/80x60	3m ³ /h	√	15	12	211428
Ø 350 cm	120 cm	10.102 l	146 kg	1/80x60	3m ³ /h	√	15	12	211435
Ø 300 cm	120 cm	7.418 l	136 kg	1/80x60	3m ³ /h	√	15	12	228754
Ø 240 cm	120 cm	4.750 l	120 kg	1/80x60	3m ³ /h	√	15	12	240831



	Medida piscina Pool size Dimensions piscine Misura piscina cm	Espacio necesario Necessary space Espace necessaire Spazio necessario cm
KIT730ECO	730x375	770x595
KIT610ECO	610x375	650x595
KIT500ECO	500x300	540x520



	Medida piscina Pool size Dimensions piscine Misura piscina cm	Espacio necesario Necessary space Espace necessaire Spazio necessario cm
KIT550ECO	550 Ø	600x600
KIT460ECO	460 Ø	500x500
KIT350ECO	350 Ø	400x400
KIT300ECO	300 Ø	350x350
KIT240ECO	240 Ø	300x300

DREAM POOL



- Liner PVC azul 40/100
- Perfileria acero
- Protectores inyección
- PVC blue liner 40/100
- Steel profiles
- Injection saver
- Liner PVC couleur bleu 40/100
- Poteaux et margelles acier
- Protections moulées par injection
- Liner PVC blu 40/100
- Profili in acciaio
- Angolare di protezione



PROV7070

- KITPROV7070**
- KITPROV6270**
- KITPROV4870**



PROV613



- Liner PVC azul 30/100
- (KITPROV613 Liner PVC azul 40/100)
- PVC blue liner 30/100
- (KITPROV613 PVC blue liner 40/100)
- Liner PVC couleur bleu 30/100
- (KITPROV613 Liner PVC couleur bleu 30/100)
- Liner PVC blu 30/100
- (KITPROV613 Liner PVC blu 40/100)

- KITPROV613**
- KITPROV503**



PR453

- KITPR453**
- KITPR353**
- KITPR303**



SERIE VARADERO

- Depuradora arena
- Caudal grupo 4 m³/h
- Escalera de seguridad
- 2x3 Peldaños
- Tapiz de suelo
- Polietileno 115 g/m²
- Sand filter
- Flow group 4 m³/h
- Safety Ladder
- 2x3 Steps
- Floor tapestry
- Polythene 115 g/m²
- Epurateur sable
- Débit groupe 4 m³/h
- Échelle sécurité
- 2x3 Marches
- Tapis de sol
- Polyéthylène 115 g/m²
- Filtro a sabbia
- Caudale gruppo 4 m³/h
- Scala di sicurezza:
- 2x3 Gradini
- Telo di protezione
- Polietilene 115 g/m²

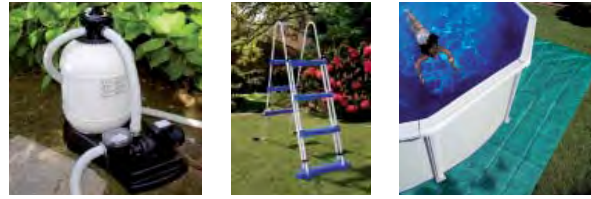

710x475 cm	120 cm	27.872 l	371 kg	1/90x80	4m ³ /h	√	√	15	12	211626
640x390 cm	120 cm	20.652 l	311 kg	1/90x80	4m ³ /h	√	√	15	12	211633
500x340 cm	120 cm	13.696 l	284 kg	1/90x80	4m ³ /h	√	√	15	12	231921



	Medida piscina Pool size Dimensions piscine Misura piscina cm	Espacio necesario Necessary space Espace necessaire Spazio necessario cm
KITPROV7070	710x475	755x510
KITPROV6270	640x390	700x430
KITPROV4870	500x340	540x380

SERIE BORA BORA

- Filtro cartucho
- 3,8 m³/h
- Escalera de seguridad
- 2x3 Peldaños
- Cartidge filter
- 3,8 m³/h
- Safety Ladder
- 2x3 Steps
- Epurateur a cartouche
- 3,8 m³/h
- Échelle sécurité
- 2x3 Marches
- Depuratore cartuccia
- 3,8 m³/h
- Scala di sicurezza:
- 2x3 Gradini



610x375 cm	120 cm	20.893 l	210 kg	1/80x60	3,8m ³ /h	√	-	15	12	220437
500x300 cm	120 cm	14.550 l	205 kg	1/80x60	3,8m ³ /h	√	-	15	12	220260
Ø 460 cm	120 cm	17.450 l	149 kg	1/80x40	3,8m ³ /h	√	-	15	12	209005
Ø 350 cm	120 cm	10.102 l	109 kg	1/80x40	3,8m ³ /h	√	-	15	12	209012
Ø 300 cm	120 cm	7.418 l	94 kg	1/80x40	3,8m ³ /h	√	-	15	12	233901



	Medida piscina Pool size Dimensions piscine Misura piscina cm	Espacio necesario Necessary space Espace necessaire Spazio necessario cm
KITPROV613	610x375	650x595
KITPROV503	500x300	540x520



	Medida piscina Pool size Dimensions piscine Misura piscina cm	Espacio necesario Necessary space Espace necessaire Spazio necessario cm
KITPR453	460 ø	500x500
KITPR353	350 ø	400x400
KITPR303	300 ø	350x350

DREAM POOL



WPR45W

- Liner PVC azul 20/100
- Sistema overlap
- PVC blue liner 20/100
- Overlap system
- Liner PVC couleur bleu 20/100
- Système à recouvrement
- Liner PVC blu 20/100
- Sistema overlap

 **KITWPR452E**

 **KITWPR352E**

SAN MARINA®



WPR450E

 **KITWPR450E**

 **KITWPR350E**



WPR300

WPR300



SERIE LANZAROTE

- Filtro de cartucho: 1,7 m³/h
- Escalera: 2x2 Peldaños
- Cartridge filter: 1,7 m³/h
- Ladder: 2x2 Steps
- Epurateur a cartouche: 1,7 m³/h
- Échelle: 2x2 Marches
- Depuratore cartuccia: 1,7 m³/h
- Scala: 2x2 Gradini



Icon: Dimensions	Icon: Height	Icon: Filter	Icon: Weight	Icon: Storage	Icon: Filter Capacity	Icon: Ladder	Icon: Steps	Icon: Steps	Icon: Barcode
Ø 450 cm	90 cm	12.717 l	56	8/120x80	1,7m ³ /h	✓	3,5	3,5	241418
Ø 350 cm	90 cm	7.693 l	47	8/120x80	1,7m ³ /h	✓	3,5	3,5	241401

serie tenerife

Icon: Dimensions	Icon: Height	Icon: Filter	Icon: Weight	Icon: Storage	Icon: Filter Capacity	Icon: Ladder	Icon: Steps	Icon: Steps	Icon: Barcode
Ø 450 cm	90 cm	12.717 l	56	8/120x80	1,7m ³ /h	✓	3,5	3,5	241210
Ø 350 cm	90 cm	7.693 l	47	8/120x80	1,7m ³ /h	✓	3,5	3,5	241203

SERIE FORMENTERA

Icon: Dimensions	Icon: Height	Icon: Filter	Icon: Weight	Icon: Storage	Icon: Filter Capacity	Icon: Ladder	Icon: Steps	Icon: Steps	Icon: Barcode
Ø 300 cm	62 cm	3.958 l	22	28/120x80	-	-	3,5	3,5	920771



KITWPR452E / KITWPR450E 460 ø 500x500
KITWPR352E / KITWPR350E 350 ø 400x400



WPR300 300 ø 350x350



JET POOL

PISCINAS DE TUBO DE ACERO

LINER: LÁMINA DE P.V.C. DE ALTA RESISTENCIA. SOLDADURA POR ALTA FRECUENCIA. CON DESAGÜE.
ESTRUCTURA: METÁLICA PINTADA EN EPOXY-POLIESTER ATÓXICO - PARA MAYOR RESISTENCIA A LA CORROSIÓN. PATAS SOLDADAS AL CODO QUE EVITAN LA ROTURA. BASES DE P.V.C. QUE MEJORAN LA ESTABILIDAD DE LA PISCINA.

STEEL FRAME POOL

LINER: HIGH RESISTANCE PVC PLATE. HIGH-FREQUENCY WELDING. DRAIN INCLUDED.
STRUCTURE: NON TOXIC EPOXY-POLYESTER PAINT FOR HIGHER CORROSION RESISTANCE. LEGS WELDED TO ELBOW BENDS TO PREVENT BREAKS. P.V.C. BOTTOMED LEGS FOR INCREASED POOL STABILITY.

PISCINE TUBES EN ACIER

LINER: LAME EN P.V.C. À HAUTE RÉSIDANCE. SOUDURE PAR HAUTE FRÉQUENCE. ECOULEMENT.
STRUCTURE: MÉTALLIQUE PEINTE EN ÉPOXY-POLYESTER NON TOXIQUE, POUR UNE MEILLEURE RÉSIDANCE À LA CORROSION. PATTES SOUDÉES AU COUDE, POUR ÉVITER LA CASSURE. BASES EN PVC POUR AMÉLIORER LA STABILITÉ DE LA PISCINE.

PISCINE IN TUBI D'ACCIAIO

LINER: LAMINA DI P.V.C. AD ALTA RESISTENZA. SALDATURA AD ALTA FREQUENZA. CON SCARICO.
STRUTTURA: METALLICA DIPINTA IN EPOXI-POLIESTERE PER UNA MAGGIORE RESISTENZA ALLA CORROSIONE. PIEDI SALDATI AL GOMITO PER EVITARE LA ROTTURE. BASI IN P.V.C. CHE MIGLIORANO LA STABILITÀ DELLA PISCINA.





JET POOL



- Estructura tubular
- Desagüe
- Tubular structure
- Drain
- Structure tubulaire
- Écoulement
- Struttura tubolare
- Scarico



WET230

Y28



Ø 215 cm



45 cm



1.215 l



8,5



60/120x80



✓



920238

Ø 160 cm

40 cm

600 l

6

60/120x80

✓

870151

Junior



WET200



Y25



WET200

190x190 cm

45 cm

1.450 l

10,3

60/120x80

✓

920221

Y25

125x125 cm

35 cm

500 l

5,7

60/120x80

✓

870199



Complementos Complements Compléments Complements

- Pag. 38 Cubiertas isotérmicas • **Isothermic covers** • **Couvertures isothermes** • Coperture isothermiche
- Pag. 39 Cubiertas de invierno • **Winter covers** • **Couvertures pour l'hiver** • Copertura invernale
- Pag. 40 Tapices de suelo • **Floor tapestry** • **Tapis de sol** • Tappeti da pavimento
- Pag. 41 Mantas • **Bottom protective blanket** • **Couvertures de protection du fond** • Coperto di protezione fondi
- Pag. 42 Liners • **Liners** • **Fonds** • Liners
- Pag. 43 Kit reparación liner • **Liner repair kit** • **Kit réparation liner** • Kit riparazione liner
- Pag. 44 Enrolladores de cubiertas • **Telescopic cover rollers** • **Enroleurs de bâches** • Avvolgiture per piscine
- Pag. 45 Escaleras • **Ladders** • **Échelles** • Scale
- Pag. 46 Monoblocs de filtración • **Filtration kit** • **Platine de filtration** • Filtro monoblocco
- Pag. 48 Filtros de arena • **Sand filter** • **Epurateur sable** • Filtri sabbia
Cargas filtrantes • **Filter media** • **Charge filtrants** • Carico filtrante
- Pag. 49 Local técnico • **Technical room** • **Local technique** • Locale tecnico
Skimmer • **Skimmer** • **Skimmer** • Skimmer
- Pag. 50 Filtros de cartucho • **Cartridge filter** • **Epurateur a cartouche** • Filtri a cartuccia
Cartuchos • **Cartridges** • **Cartouches** • Cartucce
- Pag. 51 Bombas • **Pumps** • **Pompes** • Pompe
- Pag. 52 Tratamiento de agua • **Water treatment** • **Traitement d'eau** • Tratamiento de agua
- Pag. 53 Iluminación • **Lighting** • **Éclairage** • Illuminazione
- Pag. 54 Calefacción • **Heating systems** • **Chauffage** • Riscaldamento
- Pag. 55 Calefacción solar • **Solar heating system** • **Chauffage solaire** • Riscaldamento solare
- Pag. 56 Duchas • **Showers** • **Douches** • Docce
- Pag. 58 Repuestos • **Spare parts** • **Pièces de rechange** • Parti

Leyenda Legend Légende Legenda

BX	caja / box / boîte / scatola
BXL	caja con etiqueta / box and label / carton avec étiquette / scatola con etichetta
CB	cartoncillo / cardboard wrap / bande carton / cartone
CBX	caja litografiada / colour box / boîte de couleur / scatola serigrafata
PB	bolsa de plástico / polybag / sac plastique / busta di plastica
PBH	bolsa de plástico con cartoncillo / polybag with header / sac plastique avec bande carton / sacchetto di plastica con cartone
BL	blister
CS	doble burbuja / clamshell / double coque / doppio rivestimento
DIS	display

Cubiertas isotérmicas Isothermic covers Couvertures isothermes Coperture isothermiche

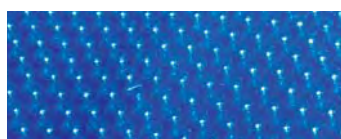

Material: Polietileno
Excepto CY29029 Y CY26200 (Pvc 15/100)
Material: Polythene
Except CY29029 And CY26200 (Pvc 15/100)
Matériel: Polyéthylène
Sauf CY29029 Et CY26200 (Pvc 15/100)
Materiale: Polietilene
Tranne CY29029 Y CY26200 (Pvc 15/100)



Espeor
Thick
Epaisseur
Spessore



	cm cm cm cm	micrones microns microns microns							unid./caja units/box unités/carton unità/scatola	código code code codice
CPROV8530	754x300	180 μ	-	850x366	-	-	-	-	PBH pack 1	214535
CPROV7320	632x300	180 μ	-	730x366	-	-	-	-	PBH pack 1	214542
CPROV6100	511x300	180 μ	-	610x366	-	-	-	-	PBH pack 1	214559
CPROV5490	470x264	180 μ	-	550x305	-	-	-	-	PBH pack 1	214566
CPROV700	672x445	180 μ	-	-	-	710x475	-	-	PBH pack 1	205830
CPROV600	620x370	180 μ	-	-	-	640x390	-	-	PBH pack 1	205847
CPROV500	472x305	180 μ	-	-	-	500x340	-	-	PBH pack 1	205854
CPROV1020	995x545	180 μ	-	-	1000x550	-	-	-	PBH pack 1	220536
CPROV915	910x460	180 μ	-	-	915x470	-	-	-	PBH pack 1	980324
CPROV810	805x460	180 μ	-	-	810x470	-	-	-	PBH pack 1	205984
CPROV730	725x370	180 μ	-	-	730x375	-	-	-	PBH pack 1	980331
CPROV610	605x370	180 μ	-	-	610x375	-	-	-	PBH pack 1	205991
CPROV505	495x295	180 μ	-	-	500x300	-	-	-	PBH pack 1	221823
CPR650	640 ø	180 μ	-	-	-	-	ø 640	-	PBH pack 1	950303
CPR550	545 ø	180 μ	-	-	-	-	ø 550	-	PBH pack 1	940601
CV450	455 ø	180 μ	-	ø 550	-	-	ø 460	ø 450 ø 460	PBH pack 1	202525
CV420	415 ø	180 μ	-	ø 488	-	-	-	-	PBH pack 1	220543
CPR400	395 ø	180 μ	-	-	-	-	-	ø 400	PBH pack 1	940625
CV375	370 ø	180 μ	-	ø 457	-	-	-	-	PBH pack 1	220550
CV350	345 ø	180 μ	-	ø 450	-	-	ø 350	ø 350	PBH pack 1	202532
CV300	295 ø	180 μ	-	ø 350	-	-	ø 300	ø 300	PBH pack 1	202549
CV250	245 ø	180 μ	-	ø 300	-	-	ø 240	-	PBH pack 1	208565

Cubiertas de invierno Winter covers Couvertures pour l'hiver Copertura invernale



Material: Polietileno
Material: Polythene
Matériel: Polyéthylène
Materiale: Polietilene

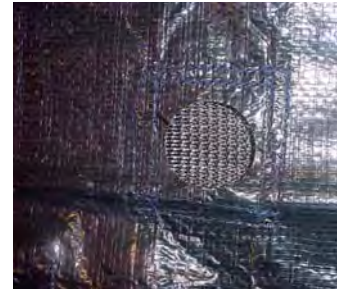

cm cm cm cm								unid./caja units/box unités/carton unità/scatola	código code codice

CIPROV1001	1115x660	100 g/m ²	-	-	1000x550	-	-	-	CBX pack 3	221854
CIPROV911	1030x560	100 g/m ²	-	-	915x470	-	-	-	CBX pack 3	208671
CIPROV821	930x560	100 g/m ²	-	-	800x470	710x475	-	-	CBX pack 3	208688
CIPROV731	820x460	100 g/m ²	-	-	730x375	640x390	-	-	CBX pack 3	208695
CIPROV611	680x460	100 g/m ²	-	-	610x375	500x340	-	-	CBX pack 3	208701
CIPROV501	610x410	100 g/m ²	-	-	500x300	-	-	-	CBX pack 3	221861
CIPR651	730 ø	100 g/m ²	-	-	-	-	ø 640	-	CBX pack 3	208718
CIPR551	640 ø	100 g/m ²	-	-	-	-	ø 550	-	CBX pack 5	208725
CIPR451	540 ø	100 g/m ²	-	ø 550	-	-	ø 460	ø 450 ø 460	CBX pack 5	208732
CIPR401	480 ø	100 g/m ²	ø 440	ø 450	-	-	-	ø 400	CBX pack 5	208749
CIPR351	440 ø	100 g/m ²	ø 360	ø 350 ø 360	-	-	ø 350	ø 350	CBX pack 5	208756
CIPR301	380 ø	100 g/m ²	-	-	-	-	ø 300	-	CBX pack 5	220567
CIPR241	330 ø	100 g/m ²	-	-	-	-	ø 240	-	CBX pack 5	220574



Tapices de suelo Floor tapestry Tapis de sol Tappeti da pavimento



Material: Polietileno
 Material: Polythene
 Matériel: Polyéthylène
 Materiale: Polietilene



cm							unid./caja	código
cm							units/box	code
cm							unités/carton	code
cm							unità/scatola	codice

TPR550	600x600	90 g/m ²	-	ø 550	ø 550	-	CBX pack 5	940656
TPR450	500x500	90 g/m ²	ø 440	ø 450	ø 460	ø 460	CBX pack 5	940663
					ø 450			
TPR400350	400x400	90 g/m ²	ø 360	ø 350	ø 350	ø 400	CBX pack 5	940670
					ø 350			

Mantas protectoras Bottom protective blanket Couvertures de protection du fond Coperto di protezione fondi



Material: Poliéster
 Material: Polyester
 Matière: Polyester
 Materiale: Poliestere



	cm	cm	cm	cm	cm	cm	cm	cm	cm	cm	unid./caja units/box unités/carton unità/scatola	código code code codice
MPROV1100	1100x600	110 g/m ²	-	-	-	1000x550	-	-	-	-	PBH pack 1	214528
MPROV915	950x500	110 g/m ²	-	-	-	915x470	-	-	-	-	PBH pack 1	980256
MPROV810	825x500	110 g/m ²	780x400	-	-	810x470	710x475	-	-	-	PBH pack 1	206004
MPROV730	750x400	110 g/m ²	660x280	-	-	730x375	640x390	-	-	-	PBH pack 1	980263
MPROV610	625x400	110 g/m ²	530x280	-	-	610x375	500x340	-	-	-	PBH pack 1	206011
MPROV500	525x325	110 g/m ²	-	-	-	500x300	-	-	-	-	PBH pack 1	231075
MPR650	650x650	110 g/m ²	-	-	-	-	-	ø 640	-	-	PBH pack 1	960111
MPR550	550x550	110 g/m ²	-	-	ø 550	-	-	ø 550	-	-	PBH pack 1	960128
MPR450	550x500	110 g/m ²	-	ø 440	ø 450	-	-	ø 460 ø 450	ø 460	-	PBH pack 1	960135
MPR400	400x400	110 g/m ²	-	ø 360	-	-	-	ø 350	ø 400	-	PBH pack 1	960142
MPR350	500x500	110 g/m ²	-	-	ø 350	-	-	ø 350 ø 300	ø 350	-	PBH pack 1	960159
MPR250	250x250	110 g/m ²	-	-	ø 240	-	-	ø 240	-	-	PBH pack 1	208572

Liners Liners Fonds Liners



Liner azul (AZ)
Blue liner (AZ)
Liner bleu (AZ)
Liner blu (AZ)

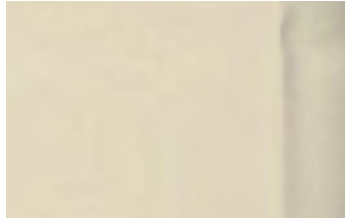

Liner arena (AR)
Sand liner (AR)
Liner sable (AR)
Liner areia (AR)



Liner cenefa (CF)
Frieze liner (CF)
Liner frise (CF)
Bordatura liner (CF)



BXL pack 1

Material: PVC Material: PVC Matériel: PVC Material: PVC



Sistema colgante (SC)
Hanging system (SC)
Rail d'accroche (SC)
Sistema pendente (SC)



Sistema overlap (OV)
Overlap system (OV)
Système à recouvrement (OV)
Sistema overlap (OV)



FPR	Color	System	Width	Height	Thickness	Barcode
FPR559	(CF)	(SC)	550	132	50/100	205892
FPR459	(CF)	(SC)	460	132	50/100	205908
FPR359	(CF)	(SC)	350	132	50/100	237572
FPR658	(AZ)	(SC)	640	132	40/100	225135
FPR558	(AZ)	(SC)	550	132	40/100	214504
FPR458	(AZ)	(SC)	460	132	40/100	224121
FPR358	(AZ)	(SC)	350	132	40/100	233918
FPR558W	(AR)	(SC)	550	132	40/100	228914
FPR458W	(AR)	(SC)	460	132	40/100	228921
FPR358W	(AR)	(SC)	350	132	40/100	234823
FPR460W	(AR)	(OV)	460	120	30/100	229126
FPR350W	(AR)	(OV)	350	120	30/100	229133
FPR240W	(AR)	(OV)	240	120	30/100	233369
FPR651	(AZ)	(SC)	640	120	40/100	980478
FPR551	(AZ)	(SC)	550	120	40/100	950648
FPR451	(AZ)	(SC)	460	120	40/100	980485
FPR352	(AZ)	(SC)	350	120	40/100	200576
FPR301	(AZ)	(SC)	300	120	40/100	216027
FPR241	(AZ)	(SC)	240	120	40/100	203010
FPR454	(AZ)	(SC)	460	90	30/100	201160
FPR354	(AZ)	(SC)	350	90	30/100	201177
FSP450	(AZ)	(OV)	450	90	20/100	990217
FSP400	(AZ)	(OV)	400	90	20/100	990224
FSP350	(AZ)	(OV)	350	90	20/100	990231
FSP300	(AZ)	(OV)	300	90	20/100	203249
FWPR 30	(AZ)	(OV)	300	65	20/100	201191



FPROV	Color	System	Width	Height	Thickness	Barcode
FPROV919	(CF)	(SC)	915x470	132	50/100	205861
FPROV819	(CF)	(SC)	810x470	132	50/100	216041
FPROV739	(CF)	(SC)	730x375	132	50/100	205878
FPROV619	(CF)	(SC)	610x375	132	50/100	216034
FPROV918W	(AR)	(SC)	915x470	132	40/100	228884
FPROV738W	(AR)	(SC)	730x375	132	40/100	228891
FPROV618W	(AR)	(SC)	610x375	132	40/100	228907
FPROV730W	(AR)	(OV)	730x375	120	40/100	237886
FPROV610W	(AR)	(OV)	610x375	120	40/100	235158
FPROV500W	(AR)	(OV)	500x300	120	30/100	235165
FPROV1028	(AZ)	(SC)	1000x550	132	40/100	224169
FPROV918	(AZ)	(SC)	915x470	132	40/100	214511
FPROV818	(AZ)	(SC)	810x470	132	40/100	224091
FPROV738	(AZ)	(SC)	730x375	132	40/100	224107
FPROV618	(AZ)	(SC)	610x375	132	40/100	224114
FPROV707	(AZ)	(SC)	700x450	120	40/100	204338
FPROV627	(AZ)	(SC)	625x375	120	40/100	204345
FPROV507	(AZ)	(SC)	500x310	120	40/100	204352
FPROV915	(AZ)	(SC)	915x470	120	40/100	980270
FPROV810	(AZ)	(SC)	810x470	120	40/100	206059
FPROV730	(AZ)	(SC)	730x375	120	40/100	980287
FPROV610	(AZ)	(SC)	610x375	120	40/100	206066
FPROV500	(AZ)	(SC)	500x300	120	40/100	221878

Kit reparación liner Liner repair kit Kit réparation liner Kit riparazione liner



Ref. 40080
DIS 1/8 BL pack 24

Kit reparación liner
Liner repair kit
Kit réparation liner
Kit riparazione liner



400803



Ref. V12
BL pack 50

Kit reparador de PVC
PVC repair kit
Kit réparation PVC
Kit per riparazioni PVC



870236



Ref. AR202
BL pack 96

Film reparador de PVC
PVC repair film
Film réparation PVC
Pellicola per riparazioni



960203

Enrolladores de cubiertas Telescopic cover rollers Enrouleurs de bâches Avvolgitore per piscine



Ref. 90170
CBX pack 1



901706

Enrollador piscinas enterradas

Enrollador de cubierta « Grandes Ruedas » para piscinas enterradas. Ofrece un desarrollo máximo de 5,50m. Ideal para piscinas redondas, cuadradas u ovaladas. Contiene tubos redondos en aluminio anodizado, un volante ergonómico con empuñadura giratoria así como un kit para atar la cubierta. Se entrega en una sola caja impresa en color.

Cover roller for inground pools

« Big Wheels » winder cover for in ground pools. Unfolds to a maximum length of 5.50 m. Suitable for round, square or oval swimming pools. Includes round anodised aluminium tubes, an ergonomic hand wheel with revolving handle as well as a kit to attach it to the cover. It is delivered in a coloured printed box.

Enrouleur pour piscines enterrées

Enrouleur de bâche « Grandes Roues » pour piscines enterrées. Il offre un développement maximum de 5,50m. Il convient aux piscines rondes, carrées ou ovales. Il est équipé de tubes ronds en aluminium anodisés, d'un volant ergonomique avec poignée tournante et d'un kit d'attache pour bâche. Il est livré en un seul colis avec impression couleur.

tournante et d'un kit d'attache pour bâche. Il est livré en un seul colis avec impression couleur.

Avvolgitore per piscine interrata

Per Avvolgitore "Grandi Ruote" per piscine interrata. Si srotola fino a un massimo di 5.50m. Adatto per le piscine tonde, quadrate e ovali. Contiene un tubo in alluminio anodizzato, una ghiera ergonomica con una impugnatura rotatoria e un kit per fissare la copertura. Consegnato in un unico imballo.



Ref. 40135
CBX pack 2



401350

Enrollador piscinas elevadas

El Enrollador ofrece un desarrollo máximo de 6,5m. Se ata fácilmente a las "playas" de la piscina con 2 placas atornilladas. El uso del enrollador permite una mejor conservación de la cubierta. Su nuevo packaging en una sola caja de color ocupa solo más o menos un metro de largo o alto gracias a la nueva definición del producto en 7 tramos de 1,05m y un octavo de 20cm. "Incluido: Conectores para piscinas tubulares."

Cover roller for above-ground pools

The Winder unfolds to a maximum length of 6.5 m. It can be easily attached to the "playa" finishing pieces of the pool using 2 bolted plates. The use of the winder enables a better conservation of the cover. Its new packaging in a single coloured box more or less about a metre in height or length, thanks to the new product redesign in 7 1.05 m sections and an eighth measuring 20cm. "Included: Connectors for tubular pools."

Enrouleur pour piscines hors-sol

Enrouleur offrant un développement maximum de 6,5m. Il se fixe facilement sur les 2 margelles de la piscine grâce à ses 2 plaques vissées. L'utilisation de l'enrouleur permet de mieux conserver la bâche dans de bonnes conditions. Son nouveau packaging en un seul colis couleur n'occupe plus qu'environ un mètre de longueur ou hauteur grâce à une nouvelle définition du produit en 7 tronçons de 1,05m et un 8ème de 20 cm. "Inclus: Connecteurs pour piscines tubulaires."

Avvolgitore per piscine fuori terra

Avvolgitore che sai srotola fi no a un massimo di 6.5 m. Si fi ssa facilmente alla "spiaggia" della piscina con 2 placche con viti. L'utilizzo dell'avvolgitore permette una migliore conservazione della

copertura. Con il suo nuovo packaging, un solo imballo solamente occupa circa un metro di lunghezza o altezza grazie al suo nuovo design in 7 pezzi da 1.05 m e un ottavo da 20 cm.

Escaleras Ladders Échelles Scale



Ref. 40110
BXL pack 1



Escalera piscina enterrada de acero inoxidable - 3 peldaños
Stainless steel inground pool ladder - 3 steps
Échelle acier inoxydable pour piscine enterrée - 3 marches
Scala per piscina interrata da 3 gradini - Inox



Ref. AR11680
BXL pack 1



231082

Escalera de acero inoxidable 142cm 2x4 peldaños + plataforma
Stainless steel ladder 142cm 2x4 steps + platform
Échelle acier inoxydable 142cm 2x4 marches + plateforme
Scala di acciaio inossidabile 142cm 2x4 gradini + piattaforma



Ref. ES1150
BXL pack 1



Escalera de seguridad 134cm 2x3 peldaños + plataforma
Safety ladder 134cm 2x3 steps + platform
Échelle sécurité 134cm 2x3 marches + plateforme
Scala di sicurezza 134cm 2x3 gradini + piattaforma



Ref. ES1100
BXL pack 1



233772

Escalera de seguridad 120cm 2x3 peldaños
Safety ladder 120cm 2x3 steps
Échelle sécurité 120cm 2x3 marches
Scala di sicurezza 120cm 2x3 gradini



Ref. ET1200
BXL pack 1



Escalera tipo tijera 120cm 2x3 peldaños
Ladder 120cm 2x3 steps
Échelle 120cm 2x3 marches
Scala 120 cm 2x3 gradini



Ref. AR109
BXL pack 1



980522

Escalera tipo tijera 98cm 2x2 peldaños
Ladder 98cm 2x2 steps
Échelle 98cm 2x2 marches
Scala 98cm 2x2 gradini

Monoblocs de filtración Filtration kit Kits de filtration Filtro monoblocco

Las impurezas quedan retenidas en la arena de sílex (filtro) en el interior de la cuba. Son muy compactos, fáciles de instalar, utilizar y no requieren especial atención. Incorporan un prefiltro para retener las partículas excesivamente grandes y evitar dañar la bomba así como un manómetro que indica la presión del caudal. Gracias a su válvula selectora (5/6 vías dependiendo del modelo), permiten realizar diferentes funciones: autolimpiado, filtración, vaciado... Los filtros FA6100 / FA6080 / FA6070 / FA6050 / FA6040 / FA6030 están certificados con la **norma francesa NF P 90-318** que garantiza que cumplen con las normativas de seguridad establecidas.

Impurities are held by the silex sand (filter) inside the tank. Sand filters are compact sized, easy to install and use and special care is not required. They include a prefilter to hold the largest particles to prevent pump from any damage. Thanks to their multiport valves (5/6 ways depending on the version), different functions can be carried out: self-cleaning, filtration, emptying... Filters FA6100 / FA6080 / FA6070 / FA6050 / FA6040 / FA6030 are certified with the **standard French NF P 90-318** ensuring that they comply with the safety regulations set.



Ref. FA6100
BXL pack 1



233857



Ref. FA6080
BXL pack 1



233840



Ref. FA6070
BXL pack 1



233833



Ref. FA6050
BXL pack 1



233826



Ref. FA6040
BXL pack 1



233819



Ref. FA6030
BXL pack 1



233802



Ref. Ref. Ref.	Diámetro Diameter Diamètre Diámetro	Caudal de grupo Group flow Débit groupe Caudale gruppo	Potencia de la bomba Pump power Puissance de la pompe Potenza bombola	Carga arena (no incluida) Sand (not included) Sable (non inclus) Carico di sabbia (non incluso)	Vías Ports Voies Uscite	Código Code Code Codice
FA6100	Ø 600 mm	10.000 l/h	485 W 0,66 CV/HP	±130 kg	6	233857
FA6080	Ø 500 mm	8.000 l/h	630 W 0,86 CV/HP	±90 kg	6	233840
FA6070	Ø 430 mm	7.000 l/h	230 W 0,31 CV/HP	±68 kg	6	233833
FA6050	Ø 380 mm	5.000 l/h	180 W 0,24 CV/HP	±46 kg	5	233826
FA6040	Ø 380 mm	4.000 l/h	125 W 0,17 CV/HP	±46 kg	5	233819
FA6030	Ø 300 mm	3.000 l/h	125 W 0,17 CV/HP	±23 kg	5	233802

Les impuretés sont retenues dans le sable de silex (filtre) à l'intérieur de la cuve. Ces filtres sont très compacts et très faciles à installer et à utiliser, sans grandes exigences. Le filtre est muni d'un pré filtre qui retient les particules excessivement grandes pour éviter d'endommager la pompe. Sa soupape sélectrice (5/6 voies, suivant le modèle), permet de réaliser diverses fonctions : auto nettoyage, filtrage, vidange... Les filtres FA6100 / FA6080 / FA6070 / FA6050 / FA6040 / FA6030 sont certifiés par la **norme française NF P 90-318** garantissant qu'ils respectent les réglementations établies en matière de sécurité.

Le impurità rimangono intrappolate nella sabbia di selce (filtro) all'interno del cestello. Sono molto compatti, facili da installare e da utilizzare e non richiedono cure particolari. Sono composti da un prefiltro per trattenere le particelle eccessivamente grandi ed evitare il danneggiamento della pompa e di un manometro che indica la pressione del flusso. Grazie alla valvola selettiva della quale sono dotati (5/6 uscite a seconda del modello), consentono diverse funzioni: autopulizia, filtrazione, svuotamento... I filtri FA6100 / FA6080 / FA6070 / FA6050 / FA6040 / FA6030 sono certificati dalla **normativa francese NF P 90-318** che garantisce la loro conformità alle normative di sicurezza vigenti.



Ref. AR725
BXL pack 1



220956



Ref. AR720
BXL pack 1



220949



Ref. AR715
BXL pack 1



208992



Ref. AR710
BXL pack 1



208985



Ref. AR7051
BXL pack 1



229744



Ref. AR700
BXL pack 1



208961



w

hp



Ref. Ref. Ref.	Diámetro Diameter Diamètre Diametro	Caudal de grupo Group flow Débit groupe Caudale gruppo	Potencia de la bomba Pump power Puissance de la pompe Potenza bombola	Carga arena (no incluida) Sand (not included) Sable (non inclus) Carico di sabbia (non incluso)	Vías Ports Voies Uscite	Código Code Code Codice
AR725	Ø 600 mm	11.500 l/h	1190 W 1,62 CV/HP	±150 kg	6	220956
AR720	Ø 500 mm	9.500 l/h	820 W 1,11 CV/HP	±100 kg	6	220949
AR715	Ø 430 mm	7.500 l/h	790 W 1,07 CV/HP	±70 kg	6	208992
AR710	Ø 380 mm	6.000 l/h	630 W 0,86 CV/HP	±40 kg	6	208985
AR7051	Ø 380 mm	5.000 l/h	480 W 0,65 CV/HP	±25 kg	6	229744
AR700	Ø 300 mm	4.000 l/h	260 W 0,35 CV/HP	±25 kg	5	208961

Filtros de arena Sand filter Epurateur sable Filtri sabbia



Ref. 40175
BX pack 1



401756



Ref. 40174
BX pack 1



401749



Ref. 40173
BX pack 1



401732



Ref.	Diámetro	Caudal	Carga arena (no incluida)	Vías	Código
Ref.	Diameter	Flow	Sand (not included)	Ports	Code
Ref.	Diamètre	Débit	Sable (non inclus)	Voies	Code
Ref.	Diametro	Caudal	Carico arena (sem arena)	Vias	Codice
40175	Ø600 mm - Side	14.000 l/h	±100 kg	6	401756
40174	Ø500 mm - Side	9.000 l/h	±75 kg	6	401749
40173	Ø400 mm - Side	6.000 l/h	±50 kg	6	401732

Cargas filtrantes Filter media Médias filtrants Carico filtrante



Ref. VF025
pack 1 palet 50



240848

Vidrio filtrante saco 25kg - Granulometría 0,5 - 1 mm
Glass filter media 25 kg - Grain size 0,5 - 1 mm
Verre filtrant 25kg - Granulométrie 0,5 - 1 mm
Vetro filtrante 25kg - Granulometria 0,5 - 1 mm



Ref. AR200
pack 1 palet 40



960180

Arena - Silex 25kg -
Granulometría 0,4-0,8
Sand - Silex 25 kg -
Grain size 0,4-08
Sable - Silex 25kg -
Granulométrie 0,4-0,8
Sabbia - Silex 25kg -
Granulometria 0,4-0,8



Ref. 90365
pack 1 palet 40



903656

Sal compacta
saco 25kg
Compact salt
bag 25kg
Sel compacté
sac 25kg
Sale compatto
25kg

Local técnico Technical room Local technique Locale tecnico



Ref. ARNP30
 BXL pack 1



227672

Local técnico fabricado en madera de pino nórdico, tratamiento nivel IV clase V. Con apertura frontal y superior. Incluye troquelado para conexiones. De fácil montaje (se sirve desmontado). Medidas int.: 107x73x91cm. No incluye filtro.

Technical room made of nordic pine wood with level IV class V treatment. Upper and front opening. Connection holes included. Easy to assemble (served dismantled). Inside measurements: 107x73x91 cm. Filtration equipment not included.

Local technique en pin nordique, traitement niveau IV classe V. Avec ouverture frontale et supérieure. Inclut ouverture pour connexions. Montage facile (livré démonté). Dimensions intérieures : 107x73x91cm. N'inclut pas le filtre.

Locale tecnico in legno di pino nordico, trattamento livello IV classe V. Con apertura frontale e superiore. Include stampigliatura per connessioni. Di facile montaggio (si fornisce smontato). Misure int.: 107x73x91cm. Filtro non incluso.

Skimmer Skimmer Skimmer Skimmer



Ref. AR100
 BXL pack 1



950396

Skimmer + boquilla de impulsión
 Skimmer + return fitting
 Skimmer + buse de refoulement
 Skimmer + bocchetta



Ref. AR100W
 BXL pack 1



233192

Skimmer + boquilla de impulsión
 Skimmer + return fitting
 Skimmer + buse de refoulement
 Skimmer + bocchetta

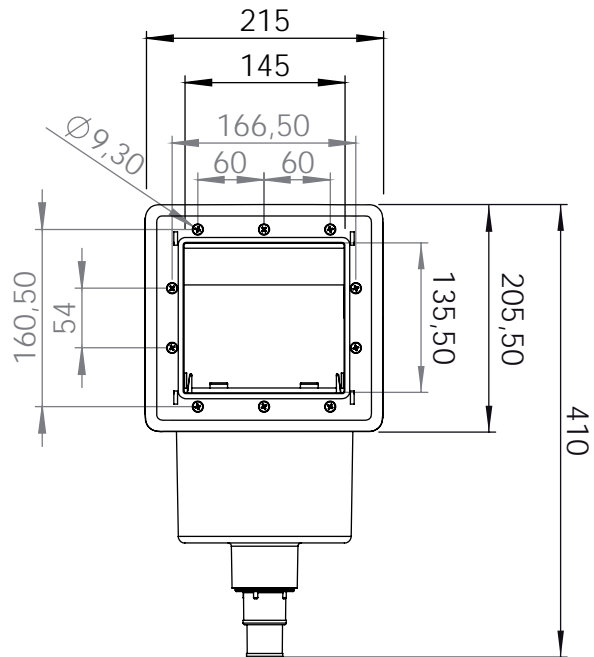



Filtros de cartucho Cartridge filter Epurateur à cartouche Filtri a cartuccia

Están especialmente concebidos para piscinas con un volumen de agua medio-inferior. Son muy sencillos de utilizar y su mantenimiento se limita a la limpieza o sustitución del cartucho o filtro de recambio, cuando éste ha quedado obstruido por la excesiva carga de suciedad.

Specially designed for medium-low water volume pools. Cartridge filters are very easy to use and their maintenance is limited to the cartridge cleaning or replacement when dirt is blocking it.

Ils sont spécialement conçus pour les piscines d'un volume d'eau moyen-inferieur. Ils sont très faciles à utiliser et l'entretien se limite au nettoyage ou au remplacement de la cartouche ou du filtre, quand il est bouché par un excès de saletés.

Pensati specialmente per piscine con un volume di acqua medio-basso. Sono molto semplici da usare e la manutenzione si limita alla pulizia o sostituzione della cartuccia o della cartuccia di ricambio, quando questa è ostruita dall'accessiva sporcizia.



Ref. AR124
Ref. AR121E
BXL pack 1

203164
210193



Ref.	Caudal	Potencia	Cartucho	Código
Ref.	Flow	Power	Cartridge	Code
Ref.	Débit	Puissance	Cartouche	Code
Ref.	Caudale	Potenza	Cartouche	Code
AR125	3.800 l/h	70 W	AR 82	970318
AR124	3.800 l/h	70 W	AR 82	203164
AR121E	2.000 l/h	72 W	AR 86	210193



Ref. AR125
BXL pack 1

970318

Cartuchos Cartridges Cartouches Cartucce



Ref. AR79

241708

Cartucho tipo A piscina autoportante
Type A Cartridge inflatable pool
Cartouche de type A piscine autoportante
Cartuccia tipo A piscina autoportante



Ref. AR86

203409

Cartucho
Cartridge
Cartouche
Cartuccia



Ref.	Modelo	Código	
Ref.	Model	Code	
Ref.	Modèle	Code	
Ref.	Modello	Codice	
AR86	CS pack 12	AR 121/118	203409
AR82	CS pack 12	AR125/124/118	970325
AR89	CS pack 12	AR11806	217017
AR79	PB pack 18	Type A	241708



Ref. 90182
CBX pack 24

901829

Limpiador de cartucho de filtro
Filter cartridge cleaner
Nettoyeur de cartouche de filtre
Pistola per pulire le cartucce

Bombas Pumps Pompes Pompe

Gama de bombas autoaspirantes GRE con potencias comprendidas entre 1/3 CV y 2 CV. Se trata de bombas centrifugas de una sola etapa, autocebantes, concebidas para uso con un sistema de filtración de piscina.

The self-priming pump range GRE emits power between 1/3 CV and 2 CV. Centrifugal pumps are single stage, self-priming pumps designed for use in a swimming pool filtration systems.

Gamme de pompes auto-aspirantes GRE, avec des puissances comprises entre 1/3 CV et 2 CV. Il s'agit de pompes centrifuges en une seule étape, auto-amorçantes, conçues pour une utilisation avec un système de filtration de piscine.

Gamma di pompe autoaspiranti GRE con potenze comprese tra 1/3 CV e 2 CV. Si tratta di pompe centrifughe monostadio, autoadescanti, concepite per l'uso con un sistema di filtrazione per piscina.



Ref. **PP200**
CBX pack 1

Ref. **PP150**
CBX pack 1

Ref. **PP100**
CBX pack 1

Curvas de rendimiento hidráulico Hydraulic performance curves
Courbes de performances hydrauliques Curve delle prestazioni idrauliche

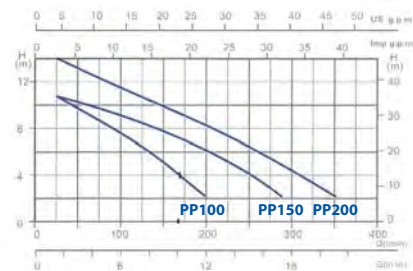

Ref. **PP075**
CBX pack 1

Ref. **PP050**
CBX pack 1

Ref. **PP030**
CBX pack 1

Curvas de rendimiento hidráulico Hydraulic performance curves
Courbes de performances hydrauliques Curve delle prestazioni idrauliche

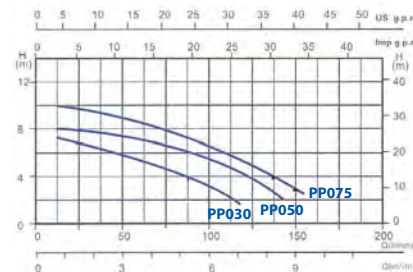

Ref.	Potencia Power	Potencia Power	Caudal máximo Maximum flow	Volumen máximo Maximum volume	Ø de filtro recomendado Filter recommended Ø	Código Code
Ref.	Puissance	Puissance	Débit maximum	Volume maximum	Ø de filtre recommandé	Code
Ref.	Potenza	Potenza	Caudal massimo	Volume massimo	Ø raccomandato filtro	Código
PP200	2 CV/HP	1471 w	27 m ³ /h	170 m ³	800 mm	237589
PP150	1,5 CV/HP	1104 w	22 m ³ /h	135 m ³	700 mm	237596
PP100	1 CV/HP	736 w	20 m ³ /h	100 m ³	600 mm	237602
PP075	3/4 CV/HP	552 w	9,5 m ³ /h	65 m ³	500 mm	237619
PP050	1/2 CV/HP	368 w	8,5 m ³ /h	50 m ³	400 mm	237626
PP030	1/3 CV/HP	245 w	7 m ³ /h	35 m ³	300 mm	237633

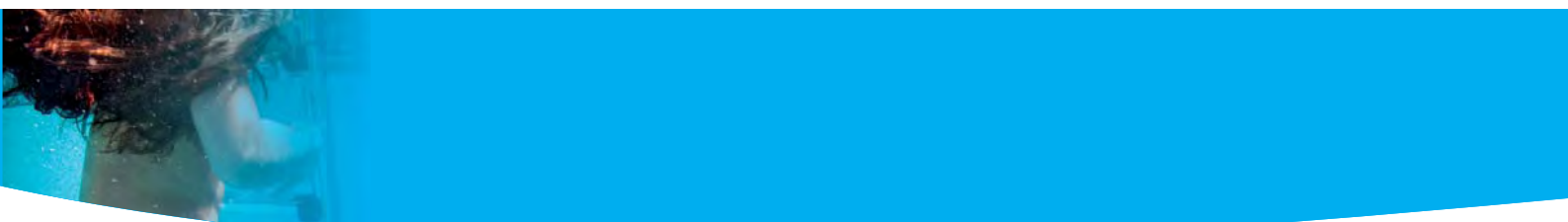

Tratamiento de agua Water treatment Traitement de l'eau Trattamento acqua

Los cloradores por electrolisis de sal generan cloro para la desinfección de la piscina a partir de sal. La electrolisis de sal tiene varias ventajas: genera y dosifica automáticamente el cloro en la piscina, evita el almacenamiento y la manipulación de producto químico y es totalmente seguro, ya que sólo utiliza sal común.

Through electrolysis of salt, the chlorinators generate chlorine and salt to disinfect the swimming pool. The electrolysis of salt has various advantages: Generating and automatically dosing the chlorine in the swimming pool, avoids the handling and storage of chemical products and it completely safe, using only sodium chloride.

Les chlorinateurs par électrolyse au sel génèrent du chlore pour la désinfection de la piscine grâce au sel. L'électrolyse au sel présente plusieurs avantages : Elle génère et dose automatiquement le niveau de chlore dans la piscine, évite le stockage et la manipulation de produits chimiques et est complètement sûre, étant donné qu'elle n'emploie que du sel commun.

I cloratori per elettrolisi salina producono cloro per la disinfezione della piscina partendo dal sale. L'elettrolisi salina ha diversi vantaggi: produce e provvede al dosaggio automatico del cloro nella piscina, evita l'immagazzinamento e l'uso di prodotti chimici ed è del tutto sicura in quanto fa uso del sale comune.



Ref. EES025
BX pack 1
Hasta 25 m³ - Until 25 m³ - Jusqu'à 25 m³ - Fino a 25 m³

240787

Ref. EES050
BX pack 1
Hasta 50 m³ - Until 50 m³ - Jusqu'à 50 m³ - Fino a 50 m³

240794

Ref. EES080
BX pack 1
Hasta 80 m³ - Until 80 m³ - Jusqu'à 80 m³ - Fino a 80 m³

240800

Electrolisis de sal para piscinas enterradas Generación automática de cloro y dureza del agua. Inversión automática de polaridad. Apta para temperatura de agua superior a 15°C y un pH entre 7,0 y 7,2.

Salt chlorinator for in-ground pools Automatic chlorine and water hardening creation. Automatic polarity reversal. Suitable for water temperatures above 15 °C and a pH reading between 7.0 and 7.2.

Chlorinateur pour piscines enterrées Production automatique de chlore et augmentation de la dureté de l'eau. Inversion automatique de la polarité. Adapté à la température de l'eau supérieure à 15 °C et un pH compris entre 7.0 et 7.2.

Cloratore di piscine interrante Generazione automatica di cloro e durezza dell'acqua. Esclusivamente per piscine interrante. Inversione di polarità automatica. Adatto per acque con temperature superiori a 15°C e pH tra 7,0 e 7,2.

DESCRIPCIÓN DESCRIPTION	EES025	EES050	EES080
Tensión de servicio Tension de service standard	230 V AC, 50 Hz./60 Hz.		
Salida (dc) Sortie (dc)	3.5 A x 2	6 A x 2	3.5 A x 6
Producción (g/h) Production (g/h)	6 - 7	10-12	17-21
Capacidad piscina (m ³) Capacité piscine (m ³) Templado: 16-24°C Tempéré 16-24°C Cálido: +25°C Chaud: +25°C	40 25	60 50	100 80
Detector flujo Décteur flux	Detector gas Décteur gaz		
Rango de salinidad/Temperatura Rang de Salinité / Température	3 12 g./l. / +15 - 40°C		
Electrodos Électrodes	Titanio con recubrimiento AUTO-LIMPIANTE, calidad ESTANDAR Duración estimada: 3.000-5.000 horas (dependiendo de la calidad del agua) Titane avec revêtement AUTO-NETTOYANTE Temps de vie prévu: 3.000-5.000 heures (suivant la qualité de l'eau)		
Control producción Contrôle production	0 - 100 % (5 niveles de producción) 0 - 100 % (5 niveles de producción)		
Inversión polaridad Inversion polarité	Programmable: 2 ⁽¹⁾ / 3 horas (jumper en plac de control) + modo test Programmable: 2 ⁽¹⁾ / 3 horas (jumper en plaque de contrôle) + mode test		
Protección nivel de sal Protection niveau de sel	Protección automática de producción Protection automatique de production		

⁽¹⁾ Configuración fábrica Valeurs par défaut de fabrique



Ref. AR2084
CBX pack 2

212753

Clorador de piscina elevadas

Sistema que desinfecta el agua de la piscina convirtiendo por electrolisis el cloruro sódico (sal) en iones de cloro. Fácil instalación. Utilizar solo Cloruro sódico con pureza 99%.

Salt chlorinator for above-ground pools

This system disinfects pool water through the electrolysis. It transforms the sodium chloride (salt) into chlorine ions. Easy to install. Use only 99 % pure salt.

Chlorateur pour des piscines hors sol

Système de désinfection de l'eau de la piscine par conversion au procédé d'électrolyse du chlorure de sodium (sel) en ions de chlore. Installation facile. Utilisé exclusivement avec du chlorure de sodium d'une pureté de 99%.

Cloratore per piscine elevate

Sistema che disinfecta l'acqua della piscina convertendo attraverso elettrolisi il cloruro di sodio (sale) in ioni cloruro. Facile installazione. Usare solo cloruro di sodio puro al 99%.

Iluminación Lighting Éclairage Illuminazione



7 colores
colors
couleurs
colori

Ref. LED30
BX pack 1



241715

Lámpara led redonda "LED BALL"
Batería recargable de litio, con mando a distancia, cambio de colores RGB, resistente al agua
Round LED lamp "LED BALL"
Rechargeable lithium battery, remote-controlled, RGB color change, waterproof
Lampe LED ronde "LED BALL"
Lithium rechargeable batterie, télécommandé changement de couleur RGB, imperméable à l'eau
Lampada rotonda LED "LED BALL"
Batteria ricaricabile agli, telecomandato , cambiamento di colore RGB, impermeabile
ø 30 cm ↑ 31 cm



7 colores
colors
couleurs
colori

Ref. LED21
BX pack 4



241722

Lampara led forma de gota "LED DECO"
Batería recargable de litio, con mando a distancia, cambio de colores RGB, resistente al agua
LED teardrop lamp "LED DECO"
Rechargeable lithium battery, remote-controlled, RGB color change, waterproof
Lampe LED larme "LED DECO"
Lithium rechargeable batterie, télécommandé, changement de couleur RGB, imperméable à l'eau
Lampada LED a goccia "LED DECO"
Batteria ricaricabile agli, telecomandato ,cambiamento di colore RGB, impermeabile
ø 17 cm ↑ 21 cm



Ref. 90173
CBX pack 12



901737

Lámpara fantasía
Los 8 diodos (LED) emisores de luz en colores brillantes crean 7 programas de luz diferentes tanto en las paredes como en el fondo de la piscina.
Fancy lamp
The 8 light issuing diodes (LED) emit light in bright colours creating 7 different lighting programmes for both walls and the floor of the swimming pool.
Lampe fantasie
8 LED brillantes et colorées créent sept jeux de lumière sur les parois et le fond de la piscine.
Lampada fantasia
8 Diodi che emettono luce di colori brillanti per creare sette giochi di luce differenti ai lati della piscina e sul fondo.



Ref.40710
BX pack 12



407109

Bombilla 300w para proyector
300w bulb for underwater light
Ampoule 300w pour projecteur
Lampada 300w per faro



Ref. AR20660
CBX pack 1



212067

Foco para piscinas
Underwater light
Projecteur pour piscines
Spot per piscina

Calefacción Heating systems Chauffage Riscaldamento



Bombas de calor

Sistema energético basado en el aprovechamiento de la energía exterior para calentar el agua de piscina, con relaciones de 1 kw consumido - 5 Kw aportados. Compresor Rotativo (Ref. AR2098 Compresor Scroll) con protección interna, batería evaporadora de alto rendimiento, ventilador axial con motor de acoplamiento directo, condensador de agua de Titanio Puro.

Heat pumps

Heating system based on the use of the energy coming from the external air to heat pool water in the ratio of 1 Kw of energy consumption to 5 Kw of output. Rotary compressor (Ref. AR2098 Scroll compressor) with internal protection, high performance battery, axial fan with direct coupling motor and Titanium water capacitor.

Pompe à chaleur

Système énergétique basé sur l'utilisation de l'énergie extérieure pour chauffer l'eau de la piscine avec un rapport de 1 Kw consommé - 5 Kw restitués. Compresseur Rotatif (Ref. AR2098 Compresseur Scroll) avec protection interne, évaporateur à haut rendement, ventilateur axial avec moteur à accouplement direct et condenseur d'eau en Titane.

Pompa di calore

Sistema energético basado en el aprovechamiento de la energía exterior para calentar el agua de piscina, con relaciones de 1 kw consumido - 5 Kw aportados. Compresor Scroll con protección interna, batería evaporadora de alto rendimiento, ventilador axial con motor de acoplamiento directo, condensador de agua de Titanio Puro.



Ref. AR2098

Comfort Heat BXL pack 1

Ref.	Volumen	Caudal	Coefficiente energético	Consumo	Potencia de calor	Potencia	Ruido	Tamaño	Peso	Código
Ref.	Volume	Flow	Energy coefficient	Consumm.	Power	Puissance	Bruit	Size	Poids	Code
Ref.	Volumen	Caudal	Coefficiente energético	Consumo	Potencia de calor	Potencia	Ruido	Tamaño	Peso	Código
AR2094	15.000 l	4.000 l/h	5	600 W	3.000 W	0,5 CV	47 dB	72x35x50 cm	34 kg	224749
AR2095	30.000 l	4.000 l/h	5	850 W	4.200 W	1 CV	47 dB	72x35x50 cm	38 kg	220598
AR2096	60.000 l	5.000 l/h	5	1.700 W	8.500 W	2 CV	51 dB	91x38x65 cm	70 kg	220604
AR2097	90.000 l	7.500 l/h	5	2.300 W	13.500 W	3 CV	58 dB	91x38x65 cm	75 kg	220673
AR2098	120.000 l	9.000 l/h	4,7	4.500 W	21.000 W	5 CV	58 dB	95x34x130 cm	110 kg	227542

Temperatura ambiental de 16°C, temperatura del agua 20°C y humedad del 70%. 16°C at room temperature, 20°C water temperature and 70% humidity. Une température de l'air extérieur de 16°C, une température d'eau de 20°C et un taux d'humidité de 70%. Temperatura aria di 16°C, 70% umidità e temperatura acqua a 20°C.



Ref. AR20750

CBX pack 1

Intercambiador de calor

Sistema diseñado para calentamiento del agua de piscinas o spas. Recomendado principalmente para pequeños volúmenes de agua. Potencia 3 kw. Incorpora termostato, y gracias a su blindaje de titanio, apenas precisa mantenimiento.

Electrical heat exchanger

System designed to heat pools or spas water. Recommended mainly for small volumes of water. Power output: 3 kw. Thermostat included. Little maintenance required due to its titanium shield.

Réchauffeur électrique

Système conçu pour le chauffage de l'eau des piscines ou spas. Recommandé principalement pour des petits volumes d'eau. Puissance 3 kw. Il intègre un thermostat, et grâce à son blindage en titane, il ne nécessite quasiment pas d'entretien.

Scambiatore di calore

Sistema disegnato per il riscaldamento dell'acqua di piscine o centri benessere. Raccomandato principalmente per piccoli volumi d'acqua. Potenza 3 kw. Include termostato e, grazie alla sua armatura in titanio, non ha praticamente bisogno di manutenzione.



211947

Calefacción solar Solar heating system Chauffage solaire Riscaldamento solare



Ref. AR2069 1 u. 600x60 cm
CBX pack 1

 203331

Ref. AR20692 2 u. 600x60 cm
CBX pack 1

 237565

Sistema para calentamiento del agua de la piscina mediante la acción Solar. Fabricado en polietileno. Aumenta la Temperatura del agua hasta 6°C. Mas de 12 kw/h de calor al día.

AR2069: 1 unidad de 600x60 cm. Peso 7 kg. Potencia de la bomba mínima recomendada: 1/3 CV.

AR20692: 2 unidades de 600x60 cm. Peso 14 kg. Funciona con cualquier bomba de piscina.

Solar pool water heating system. Made of polythene. Water temperature can be increased up to 6°C.

AR2069: 1 unit 600x60 cm. Wight: 7 kg. Minimum recommended pump output: 1/3 hp.

AR20692: 2 units 600x60 cm. Wight:14 kg. Works with any filter.

Système pour le chauffage solaire de l'eau de la piscine. Fabriqué en polyéthylène. Il augmente la température de l'eau jusqu'à 6°C.

AR2069: une unité de 600x60 cm. Poids 7 kg. Puissance de la pompe minimale recommandée: 1/3 CV.

AR20692: deux unités de 600x60 cm. Poids 14 kg. Fonctionne avec n'importe quelle pompe de piscines.

Sistema per il riscaldamento dell'acqua della piscina per mezzo dell'azione del sole. In polietilene. Aumenta la temperatura dell'acqua fino a 6°C.

AR2069: 1 unità di 600x60 cm. Peso 7 kg. Potenza minima della pompa raccomandata: 1/3 CV.

AR20692: 2 unità di cm 600x60. Peso 14 kg. Funziona con qualsiasi pompa da piscina.



Ref. AR20693
BX pack 10

 241449

Calentador solar de agua para piscinas autoportantes.

Fabricado con materiales flexibles (nylon y pvc). Medidas: 130x80 cm. Peso 1,2 kg. Aumenta la Temperatura del agua hasta 4°C. Funciona con bomba de piscina desde 4m³/h.

Solar pool water heating system for inflatable pools.

Made of flexible materials (nylon and pvc). Dimensions: 130x80 cm. Weight: 1,2 kg. Water temperature can be increased up to 4°C. Minimum water volume: 4m³/h.

Rechauffeur solaire pour piscines autoportantes.

Fabriqué avec des matériaux souples (nylon et pvc). Dimensions: 130x80cm. Poids 1,2 kg. Augmente la temperature de l'eau jusqu'a 4°C. Puissance de la pompe minimum recommandee: 4m³/h.

Sistema di riscaldamento solare di acqua per piscine autoportanti.

Fabbricato con materiali flessibili (nylon e pvc). Misure: 130x80 cm. Peso 1,2 kg. Aumenta la temperatura dell'acqua fino a 4°C. Funziona con pompe da piscina da 4m³/h.



Ref. 90230
CBX pack 1

 902307

Calentador solar. Permite aumentar la temperatura de su piscina por la acción del sol. Los calentadores pueden conectarse entre sí en serie.

Solar heating. Solar pool water heating system. The heaters should be connected in series to heat the pool.

Chauffage solaire pour piscine. Système pour le chauffage solaire de l'eau de la piscine. les réchauffeurs peuvent se connecter entre eux en série.

Riscaldatore solare. Permette di aumentare la temperatura della sua piscina tramite l'azione dei raggi solari. si possono collegare i riscaldatori tra di loro in serie.



Ref. AR2000
BXL pack 1

 221571

Kit Bypass

Contains: 3 opening/closing valves + 2 hoses Ø38 cm x 1,5 m + 6 reduction parts Ø38 - 50 mm to glue + 4 lamps

Bypass kit

Contiene: 3 Válvulas apertura/cierre + 2 mangueras Ø38 cm x 1,5 m + 6 piezas de reducción Ø38 - 50 mm para encolar + 4 abrazaderas

Kit Bypass

Comprend: 3 vannes ouverture / fermeture + 2 tuyaux Ø38 cm x 1,5 m + 6 pièces réduction Ø38 - 50 mm pour encolar + 4 colliers

Kit Bypass

Contiene: 3 valvole di apertura/chiusura + 2 tubi flessibili Ø38 cm x 1,5 m + 6 pezzi riduzione Ø38 - 50 mm da incollare + 4 fascette

Duchas Shower Douches Docce



Ref. DSALC32W
BXL pack 1



238142

Ducha solar cuadrada 32l - Aluminio.
Aspecto madera - con grifo lavapies
Square solar shower 32l - Aluminium.
Woodlike - with footwash tap
Douche solaire de jardin 32l - Aluminium.
Aspect bois - Avec robinet rince-pieds
Doccia solare piazza 32l - Alluminio.
Imitazione legno - rubinetto lavapiedi

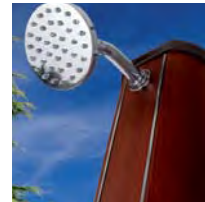

Ref. DSALR32W
BXL pack 1



238135

Ducha solar redonda 32l - Aluminio
Aspecto madera
Round solar shower 32l - Aluminium
Woodlike - with footwash tap
Douche solaire ronde 32l - Aluminium
Aspect bois - Avec robinet rince-pieds
Doccia solare round 32l - Alluminio
Imitazione legno - rubinetto lavapiedi



Ref. AR1130
BXL pack 1



224510

Ducha solar de jardín 32l - Aluminio
Con nebulizador y grifo lavapies
Graden solar shower 32l - Aluminium
Nebulizer and footwash tap
Douche solaire de jardin 32l - Aluminium
Avec brumisateur et lave-pieds
Doccia solare 32l - Alluminio
Nebulizzatore e rubinetto lavapiedi

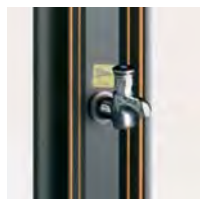

Ref. AR1035
BXL pack 1



230931

Ducha solar de jardín 38l - PVC
Graden solar shower 38l - PVC
Douche solaire de jardin 38l - PVC
Doccia solare 38l - PVC

Ref. AR1030
BXL pack 1



220765

Ducha solar de jardín 30l - PVC
Graden solar shower 30l - PVC
Douche solaire de jardin 30l - PVC
Doccia solare 30l - PVC



Ref. AR10250
 BXL pack 1



224497

Ducha solar de jardín 20 l - PVC
 Graden solar shower 20l - PVC
 Douche solaire de jardin 20l - PVC
 Doccia solare 20l - PVC



Ref. AR1020P
 BXL pack 1



240817

Ducha solar de jardín 20 l - PVC
 Garden solar shower 20l - PVC
 Douche solaire de jardin 20l - PVC
 Doccia solare 20l - PVC



Ref. 40664
 CBX pack 1



406645

Ducha solar de jardín 20 l - PVC
 Graden solar shower 20l - PVC
 Douche solaire de jardin 20l - PVC
 Doccia solare 20l - PVC



Ref. LP01
 PB pack 24

Lavapies
 Footwash
 Pédiluve
 Lavapiedi



237695

Ref. AR104
 CBX pack 12

Ducha de aluminio
 Aluminium shower
 Douche en aluminium
 Doccia alluminio



950716

Repuestos Spare parts Pièces de rechange Parti



Ref. AR500
CS pack 6



206462

Cesto para skimmer
Basket for skimmer
Panier pour skimmer
Cesto prefiltro

Ø ext. 16,2 cm ↑ 5,5 cm
Ø int. 11 cm



Ref. AR501
CS pack 12



206486

Compuerta para skimmer
Weir for skimmer
Volet pour skimmer
Paratoia

12 x 14,5 x 2 cm



Ref. AR502
CS pack 12



206493

Junta para skimmer
Skimmer layer
Joint pour skimmer
Giunto doppio di stagno

ext. 20,5 x 19,5 x 0,5 cm
int. 14,8 x 13,9 x 0,5 cm



Ref. AR503
CS pack 6



206509

Boquilla de impulsión
Return fitting
Buse de refoulement
Valvola di impulsione completa



Ref. AR505
CS pack 8



208619

Tapa para conexión de
manguera limpiafondos
Lid for connecting the vacuum
hose to the skimmer
Couvercle pour relier le tuyau
flottant au skimmer
Adaptatore del pulisci fondo



Ref. AR506
CS pack 8



208602

Manómetro
Pressure gauge
Manomètre
Manometro



Ref. AR512
CS pack 12



Válvula apertura/cierre Ø38-Ø32
Open/close valve Ø38-Ø32
Vanne ouverture/fermeture Ø38-Ø32
Valvula di apertura/chisura Ø38-Ø32



Ref. AR508
CS pack 11



Zuncho universal
Filter ring
Collier de fixation
Ghiera filtro



Ref. AR510
CS pack 24



Cintaflón y 4 abrazaderas
Cintaflon and 4 clamps
Teflon et 4 colliers
Cintaflon e 4 fascette



Ref. Y12
CS pack 50



2 filtros para limpiafondos ventury
2 filters for ventury bottom cleaner
2 filtres pour aspirateur de fond
2 filtri per puliscifondi venturi



Ref. Y13
CS pack 24



5 filtros de skimmer
5 filter savers
5 filtres pour skimmer
5 filtri di skimmer



Ref. 40045
CS pack 30



10 filtros de skimmer
10 filter savers
10 filtres pour skimmer
10 filtri di skimmer

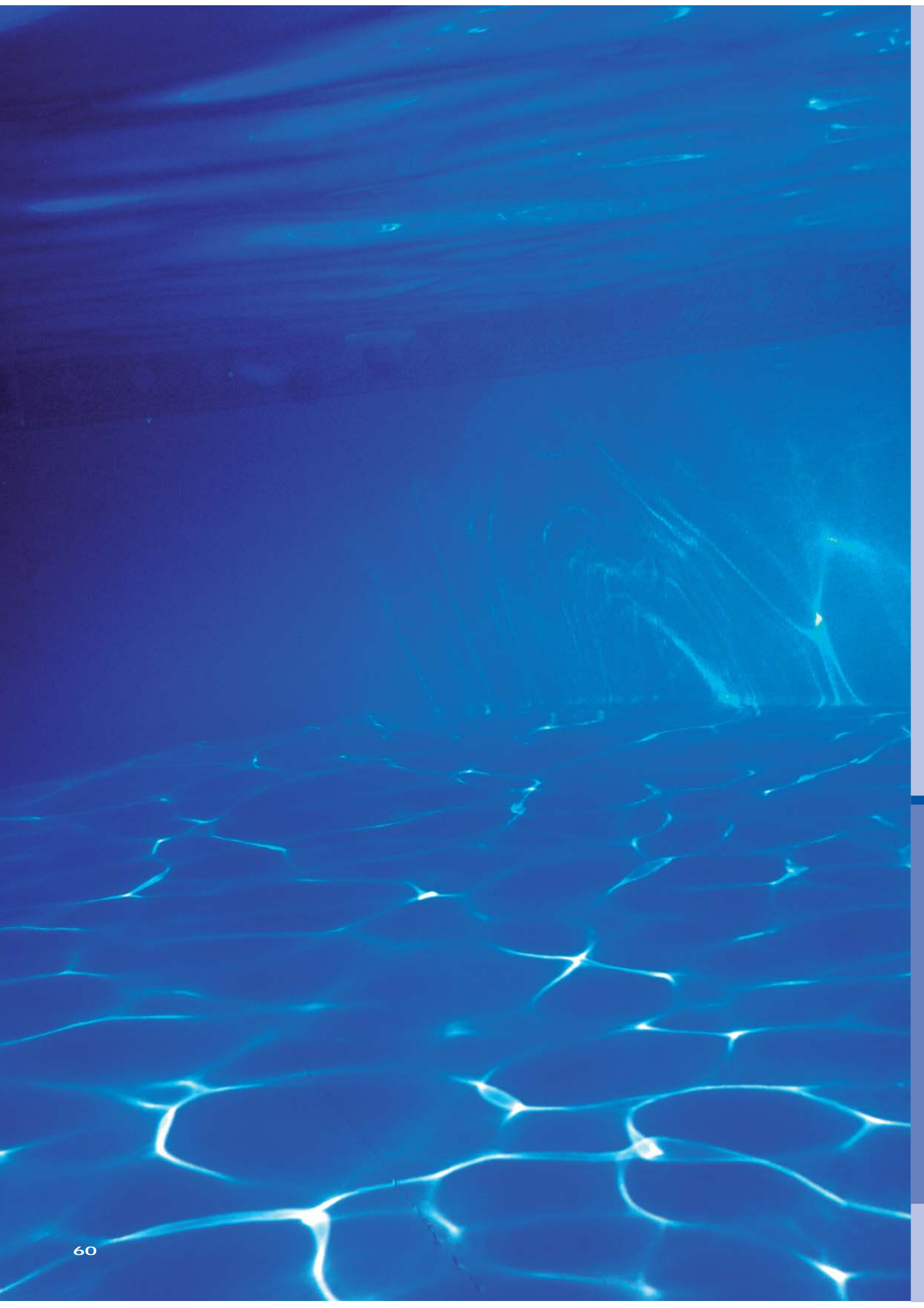

Material de limpieza Cleaning material Matériel de nettoyage Materiale di pulizia

- Pag.64 Robots • Robots • Robots • Robots
- Pag.66 Limpiafondos automáticos • Automatic cleaners • Nettoyeurs automatiques • Puliscifondi automatici
- Pag.68 Kits limpiafondos de aspiración • Vacuum cleaner kits • Kit nettoyeurs pour aspiration • Kit pulitore fondo ad aspirazione
- Pag.70 Limpiafondos Ventury • Ventury Vacuum • Aspirateurs de fond ventury • Puliscifondi Ventury
- Pag.71 Kits mantenimiento • Maintenance kits • Kits de nettoyage • Kit di mantenimento
- Pag.72 Gama Superluxe • Superluxe range • Gamme Superluxe • Gamma Superluxe
- Pag.73 Limpiafondos manuales • Vacuum heads • Balais manuels • Puliscifondo manuale
- Pag.74 Dosificadores • Dispensers • Doseurs • Dosatori
Termómetros • Thermometers • Thermomètres • Termometri
- Pag.75 Mangos telescópicos • Telescopic handles • Manches télescopiques • Manico telescopico
- Pag.76 Cepillos • Brushes • Brosses • Spazzole
- Pag.77 Recogehojas • Leaf nets and rakes • Épuisettes • Raccoglitori
- Pag.78 Mangueras flotantes • Vacuum hoses • Tuyaux flottants • Tubi galleggianti
- Pag.81 Protección invierno • Winter protection • Protection hiver • Protezione inverno



Leyenda **Legend** Légende **Legenda**

BX	caja / box / box / scatola
BXL	caja con etiqueta / box and label / carton avec étiquette / scatola con etichetta
CB	cartoncillo / cardboard wrap / bande carton / cartone
CBX	caja litografiada / coulour box / boîte de couleur / scatola serigrafata
PB	bolsa de plástico / polybag / sac plastique / busta di plastica
PBH	bolsa de plástico con cartoncillo / polybag with header / sac plastique avec bande carton / sacchetto di plastica con cartone
BL	blister
CS	doble burbuja / clamshell / double coque / doppio rivestimento
DIS	display
	cable / cable / câble / cavo
	manguera / hose / tuyau / tubo

Formatos **Formats** Formati **Formati**

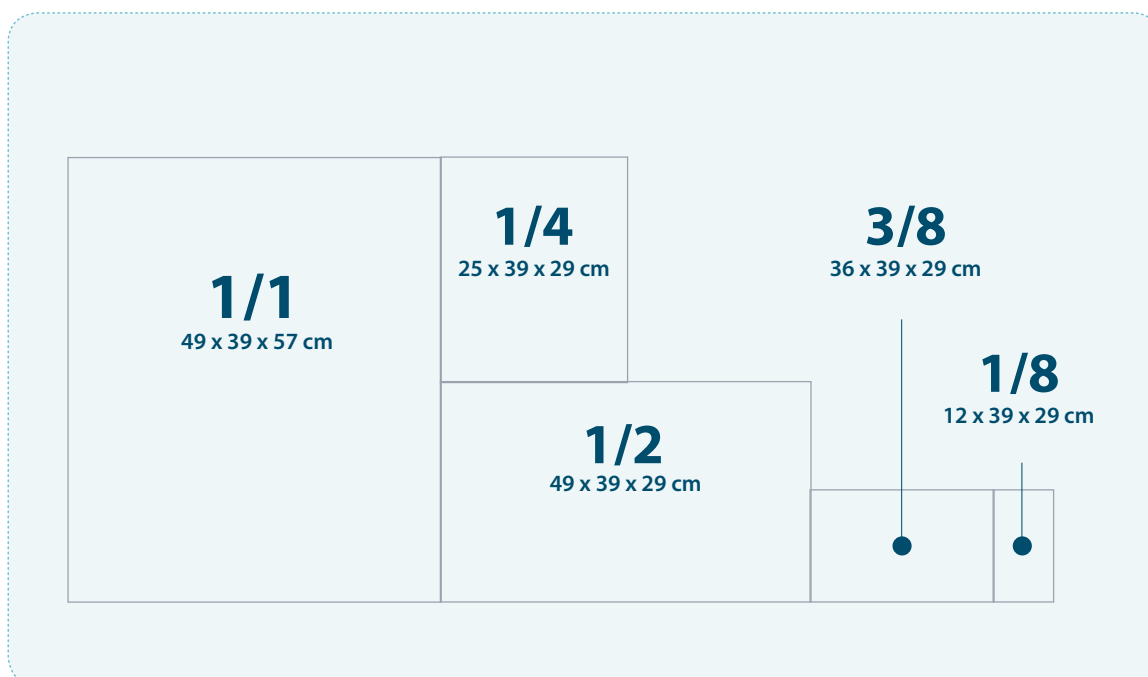

Robots Robots Robots Robots

Max. 80m²



Fondo + paredes + línea de agua
Floor + walls + waterline
Fond + parois + ligne d'eau
Fondo + pareti + linea dell'acqua

TOPACCESS



Ref. RKF100CR Robot Kayak Future CR



241739

CBX pack 1

18 m

Robot autónomo que limpia el fondo y las paredes hasta la línea de agua. Adaptado a todo tipo de piscinas hasta 80m². El Kayak Future con control remoto limpia su piscina en 3 horas. Entregado con su carrito para facilitar su manipulación y almacenamiento. Potencia de filtrado: 16 m³/h. De fácil manejo por control remoto.

Autonomous robot that cleans the bottom and the walls up to the waterline. Suitable for all swimming pool types up to 80m². The Kayak Future remote controlled cleans your pool within 3 hours. Delivered with its trolley for easy handling and storage. Filter capacity: 16 m³/h Automatic remote controlled.

Robot autonome qui nettoie le fond et les parois jusqu'à la ligne d'eau. Adapté à tous types de piscines jusqu'à 80m². Le Kayak Future télécommande nettoie la piscine en 3 h. Livré avec son chariot afin de faciliter sa manipulation et son rangement. Puissance de filtration: 16 m³/h. Il se manipule au moyen d'une télécommande.

Robot autonomo che pulisce il fondo e le pareti della piscina fino al bordo dell'acqua. Adatto a tutti i tipi di piscine, fino a 80m². Il robot Kayak Future radiocomandato pulisce in 3 ore. Comprende anche un carrello per facilitare il suo utilizzo e riporlo senza difficoltà. Potenza della filtrazione: 16 m³/h. Modello radiocomandato.

Max. 80m²



Fondo + paredes + línea de agua
Floor + walls + waterline
Fond + parois + ligne d'eau
Fondo + pareti + linea dell'acqua

TOPACCESS



Ref. RKF100 Robot Kayak Future



241746

CBX pack 1

18 m

Robot autónomo que limpia el fondo y las paredes hasta la línea de agua. Adaptado a todo tipo de piscinas hasta 80m². El Kayak Future limpia su piscina en 3 horas. Entregado con su carrito para facilitar su manipulación y almacenamiento. Potencia de filtrado: 16 m³/h.

Autonomous robot that cleans the bottom and the walls up to the waterline. Suitable for all swimming pool types up to 80m². The Kayak Future cleans your pool within 3 hours. Delivered with its trolley for easy handling and storage. Filter capacity: 16 m³/h

Robot autonome qui nettoie le fond et les parois jusqu'à la ligne d'eau. Adapté à tous types de piscines jusqu'à 80m². Le Kayak Future nettoie la piscine en 3 h. Livré avec son chariot afin de faciliter sa manipulation et son rangement. Puissance de filtration: 16 m³/h

Robot autonomo che pulisce il fondo e le pareti della piscina fino al bordo dell'acqua. Adatto a tutti i tipi di piscine, fino a 80m². Il robot Kayak Future pulisce in 3 ore. Comprende anche un carrello per facilitare il suo utilizzo e riporlo senza difficoltà. Potenza della filtrazione: 16 m³/h.

Max. 60m²



Fondo plano o inclinado
Flat or sloping bottom
Fond plat ou pentes douces
Fondo piano o inclinato

Ref.RKC100J Robot Kayak Clever



241753

CBX pack 1



TOPACCESS

Limpia el fondo de su piscina en 2 horas máximo. Independiente del equipo de filtración, funciona a 12v. Potencia de filtrado: 18m³/h
Robot autónomo que limpia el fondo de cualquier piscina de fondo plano o inclinado.

Cleans the bottom of your pool within 2 hours maximum. Stand alone from the filtering equipment, runs at 12v. Filter capacity: 18m³/h
Autonomous robot that cleans flat or sloping bottom surface pools.

Il nettoie le fond de votre piscine en 2 heures maximum. Indépendant de la filtration, il fonctionne en basse tension (12v). Puissance de filtration: 18m³/h. Robot autonome qui nettoie des piscines fond plat ou pentes douces.

Pulisce il fondo della piscina in massimo 2 ore. Indipendente dal gruppo di filtrazione, funziona a 12v. Potenza della filtrazione: 18m³/h
Robot automatico che pulisce il fondo piano o inclinato di qualsiasi piscina.

Recambios bolsa filtrante **Spare filtration bags** Recharge sac filtrant **Ricambi sacco filtro**

Ref. 40683

PB pack 2



Recambio de bolsa filtrante textil para Robot Kayak - 2 bolsas

Reutilizables - lavables

Spare filtration bag for Kayak Robot - 2 units

Reusable - Washable

Recharge sac textile pour Robot Kayak- carton de 2 pièces

Réutilisable - Lavable

Busta per Robot Kayak - textil - scatola di 2 unità

Riutilizzabile - Lavabile



406836

Ref. 40684

CBX pack 8



Bolsa para robot desechable - 3 bolsas

Non-returnable spare filtration bag - 3 units

Sac jetable pour robot - carton de 3 pièces

Busta per robot usa e getta - scatola di 3 unità



406843

Limpiafondos automáticos Automatic cleaners Nettoyeurs automatiques Puliscifondi automatici



Ref. 90397 Silence VAC

CBX pack 2

9,6 m - Ø 38



903977

Limpiafondos automático más silencioso que los sistemas tradicionales de "martillo". Su sistema de membrana le permite garantizar un rendimiento óptimo y más silencioso. Limpia el fondo y las paredes de su piscina. Funciona con sistemas de filtración de una potencia mínima de ½cv y máxima de 1½cv.

Automatic pool cleaner which is quieter than the traditional "hammer" systems. Its membrane system ensures an optimum and quieter performance. The Silence Vac cleans the bottom and walls of your pool. Works with ½ hp minimum and 1½hp maximum power filtration systems.

Nettoyeur automatique plus silencieux que les systèmes traditionnels à "marteau". Son système unique de membrane lui garantie un rendement optimum plus silencieux. Nettoie le fond et les parois de la piscine. Il fonctionne avec des systèmes de filtration d'une puissance minimum de ½cv et maximale de 1½cv.

Puliscifondo automatico più silenzioso dei sistemi tradizionali a "martello". Il suo sistema a membrana, gli permette di garantire un'ottima resa e di essere più silenzioso. Il Silence Vac pulisce il fondo e le pareti della piscina. Funziona con sistemi di filtrazione che hanno una potenza minima di ½cv e massima di 1½cv.



Ref. 19001 Classic Vac

CBX pack 1

8 m - Ø 38



190018

Limpiafondos automático para piscinas enterradas y elevadas dotadas de un equipo de filtración con una bomba de una potencia mínima de 3/4 cv.

Automatic pool cleaner for in ground and above ground pools equipped with filtering equipment with a minimum power pump of 3/4 cv.

Nettoyeur automatique de piscines enterrées et hors-sol équipé d'une filtration avec une pompe d'une puissance minimum de 3/4cv

Puliscifondo automatico per piscine interrate e fuori terra dotate di un sistema di filtrazione con una potenza minima di 3/4 cv.



Ref. 90399 Wiki Vac

CBX pack 2

6 m - Ø 32



903991

Limpiafondos automático para piscinas autoportantes y elevadas. Funciona con equipos de filtración de baja potencia: a partir de 3m³/h (0,1cv). Dispone de un prefiltro exclusivo que permite proteger el cartucho y la filtración aumentando así la vida de los equipos.

The automatic pool cleaner for inflatable or above ground pools. Works with low-power filtering equipment: ranging from 3m³/h (0.1cV). It has a unique pre-filter which protects the cartridge and filtration and in this way increasing the operating life of the equipment.

Le nettoyeur automatique pour piscines autoportantes et hors-sol. Il fonctionne avec des filtrations de très faible puissance: à partir de 3m³/h (0,1cv) minimum. Il dispose d'un préfiltre exclusif qui protège la cartouche et la filtration, augmentant ainsi leur durée de vie.

Puliscifondo per piscine autoportanti e fuoriterra. Funziona con un sistema di filtrazione a partire da 3m³/h (0,1 cv) di potenza. È dotato di un prefiltro esclusivo che permette una maggior cura della cartuccia e della filtrazione, migliorandone l'efficienza.



Ref. AR20682 Small Confort

CBX pack 4

6 m - Ø 32



232287

Limpiafondos automático por aspiración. Se conecta directamente al skimmer y es compatible con bombas a partir de 1/3CV. Incluye manguera de 6m (en 8 tramos).

Automatic suction pool cleaner that is directly connected to the skimmer. Compatible with pumps from 1/3HP. It includes 6m hose (8 sections).

Nettoyeur de fonds automatique par aspiration. Il se branche directement sur le skimmer et il est compatible avec des pompes à partir de 1/3 de CV. Comprend un tuyau de 6m (8 sections).

Puliscifondo automatico ad aspirazione. Si collega direttamente allo skimmer ed è compatibile con pompe a partire da 1/3CV. Include tubo di 6m (in 8 parti).

Kits limpiafondos de aspiración Vacuum cleaner kits Kit nettoyeur aspirants
Kit pulitore fondo ad aspirazione



Ref. AR20637 Medium Vac

CBX pack 6

9 m - Ø 32



231099

Kit de mantenimiento para piscinas autoportantes o elevadas.

Contiene: un limpiafondos de aspiración manual que incluye dos boquillas, una de ellas con cepillo + manguera 9m + pértiga 6 secciones + 3 piezas de conexión

Maintenance kit for inflatable or above ground pools. The pool cleaner includes: two suction nozzles, one with a brush + 9m hose + 6 section pole + 3 connection pieces

Le Kit d'entretien pour piscines autoportantes ou hors-sol.

Contient: un aspirateur de fond à aspiration manuelle qui inclut deux embouts, dont un avec brosse + 9m tuyau + perche 6 sections + 3 pièces de connexion

Kit di mantenimento per piscine autoportanti o fuori terra.

Contiene: puliscifondo manuale + 9m tubo + pertica 6 sezioni + 3 pezzi di connessione



Ref. 08011 Little-VAC

CBX pack 6

5 m - Ø 32



080111

Kit de mantenimiento para piscinas autoportantes o elevadas.

Contiene: limpiafondos de aspiración manual + manguera 5m + pértiga 4 secciones + 3 piezas de conexión

Maintenance kit for inflatable or above ground pools. Includes: manual power suction pool cleaner + 5m hose + 4 section pole + 3 connection pieces

Le Kit d'entretien pour piscines autoportantes ou hors-sol Il comprend: nettoyeur d'aspiration manuelle + 5m tuyau + perche 4 sections + pièces de connexion

Kit di mantenimento per piscine autoportanti o fuori terra. Contiene: puliscifondo manuale + 5m tubo + pertica 4 sezioni + 3 pezzi di connessione



Ref. AR20641
CBX pack 2



224718

Limpiafondos para pértiga + pértiga 3 secciones + recogedor de fondo + termómetro flotante + dosificador oval + cepillo para liner + manguera 6m + bote de tiras reactivas (tester)

Bottom cleaner for pole + 3 section pole + leaf skimmer of bottom + floating thermometer + oval dispenser + brush for liner + 6m hose + can of reactive test strips (tester)

Nettoyeur fond pour manche + perche 3 sections + epuisette de fond + thermomètre flottant + doseur oval + brosse pour liner + 6m tuyau + boîte de bandes test (tester)

Puliscifondi per pertica + pertica 3 sezioni + raccoglifoglie di fondi + termometro galleggiante + dosatore ovale + spazzola per liner + 6m tubo + confezione da strisce reattive (tester)



Ref. AR2064
CBX pack 4



202433

Kit limpiafondos + pértiga 3,60m (3x1,20m) + manguera 6m

Vacuum head kit + handle 3,60m (3x1,20m) + 6m hose

Kit nettoyeur + manche 3,60m (3x1,20m) + tuyau 6m

Kit puliscifondo + pertica 3,60m (3x1,20m) + tubo 6m

Limpiafondos Ventury **Ventury Vacuum** Aspirateurs de fond ventury Puliscifondi Ventury



Ref. 90111

Bx Pack 10

Limpiafondos Micro-Ventury
Micro-Ventury Vacuum
Nettoyeur Micro-Ventury
Puliscifondi Micro-Ventury



901119



Ref. Y15

CBX pack 12

Kit limpiafondos Ventury+ pértiga
Ventury vacuum kit + handle
Kit Aspirateur de fond ventury + manche
Aspiratore Ventury+ pertica



201214



Ref. Y10

CBX pack 6

Limpiafondos Ventury+ pértiga
Ventury vacuum + handle
Aspirateur de fond ventury + manche
Aspiratore Ventury+ pertica



890180

Kits mantenimiento Maintenance kits Kits de nettoyage Kit di mantenimento



Ref. KMA05
CS pack 6



237664

Kit mantenimiento piscinas: analizador pH/Cl, cepillo 45 cm, recogehojas supercie, termómetro y limpiafondos
 Pool maintenance kit: pH/Cl Test kit, 45 cm Brush, leaf net, thermometer and Vacuum head
 Kit de nettoyage pour piscines: analyse pH/Cl, brosse 45 cm, époussette de surface, thermomètre et balai manuel
 Kit di mantenimento per piscine: analizzatore ph/cl, spazzola 45 cm, raccogliore di supercie, termometro e puliscifondo



Ref. 08050
CS pack 6



080500

Kit piscina autoportante: analizador pH/Cl, cepillo, recogehojas de superficie, mango 1,20m (3 tramos) termómetro tubular, dosificador y jet vac ventury
 Special inflatable pool kit: pH/chlorine test kit, brush, leaf net, tubular thermometer, 1,20m handle (3 sections), floating dispenser and ventury vacuum.
 Kit spécial piscine autoportante: trousse d'analyse pH/Cl, brosse, époussette de surface, manche 1,20m (3 parties), thermomètre tubulaire, doseur pastilles rétractable et jet vac ventury
 Kit speciale per piscina autoportante: analizzatore pH/Cl, spazzola, Raccogliore di superfi cie, manico 1,20m (3 sezioni) termometro tubolare, dosatore e aspiratore jet vac ventury

Gama Superluxe Superluxe range Gamme Superluxe Gamma Superluxe



Ref. LCBP45

CS pack 12

Cepillo Luxe ballena 45 cm para paredes
45 cm wall whale brush

Baleine Luxe Brosse 45 cm pour les murs
Spazzola Luxe balena 45 cm per le pareti



241760



Ref. LBP40

CB pack 12

Cepillo Luxe de 34 cm con cerdas de plástico
Luxe brush 34 cm

Brosse Luxe 34 cm
Spazzola Luxe 34 cm



241777



Ref. LAMF10

CS pack 6

Cabezal Luxe aspirador manual flexible con cepillos
Flexible Luxe suction pool cleaner with brushes

Nettoyeur de fonds aspiration flexible Luxe avec de brosses
Puliscifondi aspirazione Luxe flessibile con spazzole



241784



Ref. LAMTF10

CB pack 6

Cabezal Luxe aspirador manual triangular flexible
Flexible Luxe triangular suction pool cleaner

Nettoyeur de fonds aspiration flexible triangulaire Luxe
Puliscifondi aspirazione Luxe triangolare flessibile



241821



Ref. LRF10

CB pack 12

Recogehojas de fondo Luxe con malla de nylon
Nylon net Luxe leaf rake

Époussette de fond Luxe avec filet de nylon
Raccogliatore di fondo Luxe con la maglia di nylon



241791



Ref. LRS10

CB pack 12

Recogehojas de superficie Luxe con malla de nylon
Nylon net Luxe leaf net

Époussette de surface Luxe avec filet de nylon
Raccogliatore di superficie Luxe con la maglia di nylon



241807



Ref. LDCT200

PBH pack 12

Dosificador triangular pastillas de 200-250 gr
Triangular dispenser 200-250 gr tablets

Doseur flottant triangulaire pastilles de 200 - 250 gr
Dosatore galleggiante pastiglie da 200-250 gr



241814

Limpiafondos manuales **Vacuum heads** Balais manuels Puliscifondo manuale



Ref. AR2050
CBX pack 6

Limpiafondos de aspiración con cepillos rotativos
Suction pool cleaner with rotary brushes
Nettoyeur de fonds, aspiration avec brosses rotatives
Puliscifondi aspirazione con spazzole rotative



224954



Ref. 40022
BX pack 6

Limpiafondos de aluminio
Aluminium vac head
Balai en aluminium
Alluminio puliscifondo



400223



Ref. 40016
DIS 1/2 pack 6

Limpiafondos triangular rotativo
Triangular swivelling vac head
Balai triangulaire rotatif
Puliscifondo triangolare rotante



400162



Ref. 40017
DIS 1/2 pack 6

Limpiafondos ovalado rotativo con cepillos laterales
Oval swivelling vac head with lateral brushes
Balai oval rotatif avec brosses latérales
Puliscifondo ovale rotante con spazzole laterali



400179



Ref. 40018
DIS 1/2 pack 6

Limpiafondos manual rotativo 8 ruedas con cepillos laterales
Swivelling vacuum head 8 wheels with lateral brushes
Balai manuel rotatif 8 roues avec brosses latérales
Puliscifondo manuale con 8 ruote e spazzole laterali



400186



Ref. 40092
DIS 1/4 pack 18

Empuñadura clip Ø28mm
Clip handle Ø28mm
Poignée clip Ø28mm
Impugnatura clip Ø28mm



400926

Dosificadores Dispensers Doseurs Dosatori



Ref. DCT20
DIS 1/2 pack 40

Combi Thermo-dosificador: Dosificador pastillas de 20 g + Termómetro
Combi Thermo-dosifier: Dosifier 20 g tablets + Thermometer
Combi Thermo-doseur: Doseur pastilles de 20 g) + Thermomètre
Combi Thermo-Dosatore Tavolette da 20 g + Termometro



241463



Ref. 40070
DIS 1/2 pack 6

Combi Thermo-dosificador: Dosificador Capacidad 1,5 Kg (pastillas de 20 a 500 g) + Termómetro + Visor de consumo de producto
Combi Thermo-dosifier: Dosifier Capacity 1,5 kg (20 500 g tablets) + Thermometer + Product Consumption Viewer
Combi Thermo-doseur: Doseur Capacité 1,5 Kg (pastilles de 20 à 500 g) + Thermomètre + Viseur de consommation de produit
Combi Thermo-Dosatore Capacità 1,5 kg (Tavolette da 20 a 500 g) + Termometro + Vista de consumo de prodotto



400704



Ref. AR7
CBX pack 12

Dosificador flotante. 5 pastillas de 200 g
Floating dispenser. Capacity: 7 tablets 200 g
Doseur flottant. Capacité 7 pastilles de 200 g
Dosatore galleggiante. Capacità 7 pastiglie da 200 g



940892



Ref. 40071
DIS 1/2 pack 30

Dosificador flotante. Capacidad: 7 pastillas de 20 g
Floating dispenser. Capacity: 7 tablets 20 g
Doseur flottant. Capacité 7 pastilles de 20 g
Dosatore galleggiante. Capacità 7 pastiglie da 20 g



400711

Termómetros Thermometers Thermomètres Termometri



Ref. 40051
DIS 1/4 pack 18

Termómetro tubular flotante
Tubular floating thermometer
Thermomètre flottant tubulaire
Termometro galleggiante tubolare



400513



Ref. 40054
DIS 1/2 pack 10

Termómetro boya
Buoy thermometer
Thermomètre bouée
Termometro galleggiante



400544



Ref. 40055
CB pack 15

Termómetro bola
Ball thermometer
Thermomètre boule
Termometro a palla



400551



Ref. 40050
CS pack 12

Termómetro "Big" - Doble lectura
"Big" thermometer - double reading
Thermomètre bouée - Double lecture
Termometro "Big" - Doppio lettura



400506

Mangos telescópicos **Telescopic handles** Manches télescopiques Manico telescopico



Ref. 40013
BX pack 20

Mango telescópico plateado 2,40m (2x1,20m)
Telescopic silver handle 2,40m (2x1,20m)
Manche télescopique argenté 2,40m (2 x 1,20m)
Manico telescopico argentato 2,40 m (2 x 1,20)



400131

Ref. 40010
BX pack 10

Mango telescópico plateado 3,60m (2x1,80m)
Telescopic silver handle 3,60m (2 x 1,80m)
Manche télescopique argenté 3,60 (2 x 1,80m)
Manico telescopico argentato 3,60 m (2 x 1,80)



400100

Ref. 40011
BX pack 10

Mango telescópico plateado 4,80m (2x2,40m)
Telescopic silver handle 4,80m (2 x 2,40m)
Manche télescopique argenté 4,80 (2 x 2,40m)
Manico telescopico argentato 4,80 m (2 x 2,40)



400117

Cepillos Brushes Broses Spazzole



Ref. 40046
DIS 1/2 pack 15

Cepillo aluminio
Aluminium brush
Brosse aluminium
Spazzola alluminio



400469



Ref. CAA25
DIS 1/2 pack 48

Cepillo aluminio para eliminar algas
Aluminium brush to eliminate the algae
Brosse aluminium pour éliminer les algues
Spazzola alluminio per eliminare le alghe



241456



Ref. 40802
DIS 1/2 pack 8

Cepillo aspirante
Vacuum brush
Brosse aspirante
Spazzola con attacco per aspirare



408021



Ref. 40041
DIS 1/1 pack 12

Cepillo Gran Formato
Big Format brush
Brosse Grand Format
Spazzola Gran Formato



400414



Ref. 40040
DIS 1/2 pack 18

Cepillo línea de agua
Waterline brush
Brosse ligne d'eau
Spazzola per bordo acqua



400407



Ref. 40806
DIS 1/4 pack 18

Cepillo aspirador limpia-esquinas
Vacuum brush
Brosse aspirante d'angle
Spazzola aspiratutto per angoli



408069

Recogehojas Leaf nets and rakes Épuisettes Raccoglitori



Ref. RHFAL
DIS 1/1 pack 12

Recogehojas fondo aluminio
Aluminium Leaf rake
Épuisette de fond aluminium
Raccoglitore di fondo alluminio



237688



Ref. RHSAL
DIS 1/1 pack 12

Recogehojas superficie aluminio
Aluminium Leaf net
Épuisette de surface aluminium
Raccoglitore di superficie alluminio



237671



Ref. 40031
CB pack 12

Recogehojas de superficie + mango telescópico
Leaf net + telescopic handle
Épuisette de surface + manche télescopique
Raccogehojas de superficie + mango telescopico



400315

Ref. 40032
DIS 1/1 pack 12

Recogehojas de fondo Gran Formato
Big format Leaf rake
Épuisette de fond Grand Format
Raccoglitore di fondo Gran formato



400322



Ref. 40030
DIS 1/1 pack 12

Recogehojas de superficie Gran Formato
Big format Leaf net
Épuisette de surface Grand Format
Raccoglitore di superficie Gran formato



400308

Mangueras flotantes Vacuum hoses Tuyaux flottants Tubi galleggianti



40180

Ref. 40181

BX pack 1

Manguera para filtro 4m - con 2 terminales Ø32mm

Filter hose 4m - with 2 cuffs Ø32mm

Tuyau de filtration 4m - avec 2 embouts Ø32mm

Tubo filtrante 4m - con 2 terminali da Ø32mm



40181

Ref. 40180

BX pack 1

Manguera para filtro 4m - con 2 terminales Ø38mm

Filter hose 4m - with 2 cuffs Ø38mm

Tuyau de filtration 4m - avec 2 embouts Ø38mm

Tubo filtrante 4m - con 2 terminali da Ø38mm



40180



Ref. AR212

BX pack 1

Manguera limpiafondos 4m con 2 terminales Ø38mm

Vacuum hose 4m - with 2 cuffs Ø38mm

Tuyau nettoyeur fond 4m - avec 2 embouts soudés Ø38mm

Tubo puliscifondo 4m - con 2 terminali da Ø38mm



240824



AR210

Ref. AR210

BX pack 1

Manguera limpiafondos 6m con 2 terminales Ø38mm

Vacuum hose 6m with 2 cuffs Ø38mm

Tuyau nettoyeur fond 6m - avec 2 embouts soudés Ø38mm

Tubo puliscifondo 6m Ø38mm - con 2 terminali da Ø38mm



960296

Ref. 40001

BX pack 1

Manguera limpiafondos 8m - con 2 terminales Ø38mm

Vacuum hose 8m - with 2 cuffs Ø38mm

Tuyau nettoyeur fond 8m - avec 2 embouts soudés Ø38mm

Tubo puliscifondo 8m - con 2 terminali da Ø38mm



400018

Ref. 40002

BX pack 1

Manguera limpiafondos 10m - con 2 terminales Ø38mm

Vacuum hose 10m - with 2 cuffs Ø38mm

Tuyau nettoyeur fond 10m - avec 2 embouts soudés Ø38mm

Tubo puliscifondo 10m - con 2 terminali da Ø38mm



400025



40001

Ref. 40003

BX pack 1

Manguera limpiafondos 12m - con 2 terminales Ø38mm

Vacuum hose 12m - with 2 cuffs Ø38mm

Tuyau nettoyeur fond 12m - avec 2 embouts soudés Ø38mm

Tubo puliscifondo 12m - con 2 terminali da Ø38mm



400032

Ref. 40004

BX pack 1

Manguera limpiafondos 15m - con 2 terminales Ø38mm

Vacuum hose 15m - with 2 cuffs Ø38mm

Tuyau nettoyeur fond 15m - avec 2 embouts soudés Ø38mm

Tubo puliscifondo 15m - con 2 terminali da Ø38mm



400049



90160

Ref. 90160
BX pack 1

Manguera 36,5m - seccionable Ø38mm
36,5m hose - sectionable Ø38mm
Tuyau 36,5m - sectionnable Ø32mm
Tubo 36,5m - tubo sezionabile Ø38mm



901607

Ref. 90161
BX pack 1

Manguera 36,5m - seccionable Ø32mm
36,5m hose - sectionable Ø32mm
Tuyau 36,5m - sectionnable Ø32mm
Tubo 36,5m - tubo sezionabile Ø32mm



901614



Ref. AR2100
BX pack 1

Kit mangueras filtración
Filtration hoses kit
Kit tuyaux pour épurateurs
Kit pompe di filtraggio



202518



Ref. 90165
CBX pack 2

Enrollador de mangueras flotantes hasta 15m. Manguera no incluida
Vacuum hoses roller maximum 15m. Vacuum hoses not included
Enrouleur de tuyaux flottants. Jusqu'à 15m. Tuyau non inclus
Avvolgitore per tubo galleggiante fino a 15 m. Tubo non incluso



901652



Ref. 40012
BX pack 20



400124

Terminal manguera flotante - Ø38mm
Hose cuff - Ø38mm
Embout tuyau flottant - Ø38mm
Raccordo per tubo Ø38 mm



Ref. 40009
BX pack 12



400094

Unión 2 mangueras flot. Ø38mm y 32mm
2 vacuum hoses union Ø38mm and 32mm
Liaison 2 tuyaux flot. Ø38mm et 32mm
Raccordo per unire 2 tubi Ø32mm - 38mm



Ref. 40095
BX pack 20



400957

Adaptador de mangueras - 38/32mm
38/32mm hose adapter
Adaptateur de tuyaux 38/32mm
Adattamento per tubo 32/38mm



Ref. 40091
BX pack 30



400919

Quitavueeltas para manguera Ø 38
38Ø hose adaptor with threaded connection
Raccord tournant pour les tuyaux Ø38mm
Adattamento per tubo ø38mm



Ref. AR509

CS pack 10

2 conectores Ø38 + 4 abrazaderas Ø38
2 connectors Ø38 + 4 clamps Ø38
2 manchons branchement tuyaux Ø38 + 4 colliers Ø38
2 raccordi Ø38 + 4 fascette Ø38



209685



Ref. AR511

CS pack 10

2 conectores Ø38/32 + 4 abrazaderas Ø38/Ø32
2 connectors Ø38/32 + 4 clamps Ø38/ Ø32
2 manchons branchement tuyaux Ø38/32 + 4 colliers Ø38/Ø32
2 raccordi Ø38/32 + 4 fascette Ø38/Ø32



215792



Ref. 60222

PB pack 10

Manguera de conexión 68 cm - ø38mm
Connection hose 68 cm - ø38mm
Tuyau de jonction 68 cm - ø38mm
Tubo di giunzione 68 cm - ø38mm



602221

Ref. 60218

PB pack 10

Manguera de conexión 58 cm - ø38mm
Connection hose 58 cm - ø38mm
Tuyau de jonction 58 cm - ø38mm
Tubo di giunzione 58 cm - ø38mm



602184



Ref. 60205

PB pack 10

Manguera de conexión 36 cm - ø38mm
Connection hose 36 cm - ø38mm
Tuyau de jonction 36 cm - ø38mm
Tubo di giunzione 36 cm - ø38mm



602054

Ref. 60215

PB pack 10

Manguera de conexión 24 cm - ø38mm
Connection hose 24 cm - ø38mm
Tuyau de jonction 24 cm - ø38mm
Tubo di giunzione 24 cm - ø38mm



602153

Protección invierno Winter protection Protection hiver Protezione inverno



Ref. 40580

BX pack 10

Flotador de invernaje
Winterising float
 Flotteur d'hivernage
 Galleggiante inverno



405808



Ref. 40581

BX pack 35

Gizzmo - protección del skimmer
Gizzmo - skimmer protection
 Gizzmo - protection du skimmer
 Gizzmo - protezione per skimmer



405815



Ref. 40582

BX pack 30

Tapón de invernaje 1,5"
Winterising plug 1,5"
 Bouchon d'hivernage 1,5"
 Tappo inverno 1.5"



405822



Ref. 40583

BX pack 30

Tapón de invernaje 2"
Winterising plug 2"
 Bouchon d'hivernage 2"
 Tappo inverno 2"



405839



Ref. 09150

BX pack 14

Kit de protección de skimmer para piscinas elevadas
Skimmer protection kit for above-ground pools
 Kit de protection de skimmer pour piscines hors-sol
 Kit protezione skimmer per piscine fuori terra



091506



Producto químico Chemicals

Produits d'entretien Prodotti chimici





Pasos para cuidar de su piscina Steps to take care of your swimming pool Etapes à suivre pour prendre soin de votre piscine



Regular el pH
pH regulation
Réguler le pH
Correttori di pH

1 



Desinfectar el agua
Water disinfection
Désinfecter l'eau
Disinfezione dell'acqua

2 



3^a 



3^b 

<p>¿Cómo? How? ¿Comment? ¿Come?</p>	<p>Minorador de pH pH reduce Baisse le pH Riduttore di pH</p> <p>Incrementador de pH pH increase Augmente le pH Incrementatore pH</p>	<p>Cloro choque Shock chlorine Chlore choc Cloro shock</p>	<p>Cloro lento Slow chloration Chlore lent Cloro lento</p> <p>Bromo Bromine Brome Bromine</p>	<p>Oxígeno activo Active oxygen Oxygène actif Ossigeno attivo</p>
<p>¿Para qué? Why? ¿Pourquoi? ¿Perché?</p>	<p>Obtener un pH entre 7,2 y 7,6 To have a pH value between 7,2 and 7,6 Obtenir un pH entre 7,2 et 7,6 Stabilizzare pH tra 7.2e 7.6</p>	<p>Desinfectar rápidamente y destruir los organismos, hongos y bacterias To disinfect quickly and to eliminate all the organisms and bacteria Désinfecter rapidement et détruire les organismes, champignons et bactéries Disinfettare rapidamente e distruggere tutti gli organismi, funghi e batteri</p>	<p>Desinfectar permanentemente To have a permanent disinfection Désinfecter en permanence Disinfezione permanente</p>	<p>Desinfectar permanentemente To have a permanent disinfection Désinfecter en permanence Disinfezione permanente</p>
<p>¿Cuándo? When? Quand? ¿Quando?</p>	<p>A diario Daily Chaque jour Trattamento quotidiano</p>	<p>Al inicio de temporada At the beginning of the swim season Début de saison Inizio stagione</p> <p>Después de condiciones climáticas extremas After bad weather conditions Après des conditions climatiques extrêmes Dopo che si sono verificate cambiamenti climatici molto forti</p> <p>Uso intensivo de la piscina High use level Usage intensif de la piscine Uso intensivo della piscina</p>	<p>A diario Daily Chaque jour Trattamento quotidiano</p>	<p>A diario Daily Chaque jour Trattamento quotidiano</p>
<p>Resultado Result Résultat Risultato</p>	<p>pH ideal para la piel y los ojos. Instalaciones en perfecto estado Ideal pH for skin and eyes. Good conditions equipment pH idéal pour la peau et les yeux. Installations en parfait état pH stabile non genera fastidi ad occhi e alla pelle</p>	<p>Agua limpia y libre de posibles contagios Clean water without contagious risk Eau propre et libre de possibles contagions Acqua pulita e libera da ogni impurità</p>	<p>Agua limpia y libre de posibles contagios Clean water without contagious risk Eau propre et libre de possibles contagions Acqua pulita e libera da ogni impurità</p>	<p>Agua limpia y libre de posibles contagios Clean water without contagious risk Eau propre et libre de possibles contagions Acqua pulita e libera da ogni impurità</p>



Prendre soin de votre piscines Indicazioni per il trattamento della sua piscina



Tratamiento antialgas
Anti-algae treatment
Traitement anti-algues
Trattamento antialghe

4

Floculación
Flocculation
Floculation
Flocculante

5



Completo 4 Acciones

Total 5 Acciones

Total 10 Acciones

	Antialgas concentrado Concentrated algacide Anti-algues concentré Antialghe concentrato	Floculante Flocculant Floculant Flocculant
	Antialgas Extra Extra anti-algae Anti-algues Extra Antialghe extra	

Prevenir la aparición de algas To avoid algae apparition Prevenir l'apparition des algues Prevenire la comparsa delle alghe	Eliminar las partículas en suspensión To eliminate particles in suspension Éliminer les particules en suspension Elimina le impurità
Eliminar las algas existentes To eliminate the algae Éliminer les algues existantes Eliminare la presenza di alghe	

Según convenga Depending on water quality Selon convenance Quando necessario	Semanalmente Weekly Chaque semaine Settimanalmente
---	---

Agua sin algas Water without algae Eau sans algues Acqua senza alghe	Agua cristalina Crystalline water Eau cristalline Acqua cristallina
---	--

Fórmula innovadora que permite en una sola aplicación, eliminar bacterias, virus y microorganismos en general
Thanks to its new formula, you can eliminate bacteria, virus and microorganisms

Formule innovatrice, il permet avec une seule application, d'éliminer bactéries, virus et microorganismes en général

Formula innovativa che permette in una sola applicazione eliminare i batteri, virus e microorganismi in generale

4 funciones: Cloro Antialgas Estabilizante Floculante	4 funciones: Chlorine Antialgae Stabiliser Flocculant	4 fonctions: Chlore Anti-algues Stabilisant Floculant	4 funzioni: Cloro Antialghe Stabilizzante Flocculante
5 funciones: Cloro Antialgas Estabilizante Floculante Anticalcáreo	5 fonctions: Chlorine Antialgae Stabiliser Flocculant Anti lime	5 fonctions: Chlore Anti-algues Stabilisant Floculant Anticalcaire	5 funzioni: Cloro Antialghe Stabilizzante Flocculante Anticalcare
10 funciones: - Bactericida - Floculante - Coagulante - Algicida - Algistático - Regulador de pH - Estabilizante de cloro - Anticalcáreo - Virucida - Fungicida	10 fonctions : - Germicide - Flocculent - Coagulant - Algicide - Algistatic - pH regulator - Chlorine stabilizer - Anti-Limescale Agent - Virucide - Fungicide	10 fonctions: - Bactéricide - Floculant - Coagulant - Algicide - Algistatique - Régulateur de pH - Stabilisant de chlore - Anticalcaire - Virucide - Fongicide	10 funzioni: - Battericida - Flocculante - Coagulante - Algicida - Alghistatico - Regolatore de pH - Stabilizzante del cloro - Anticalcare - Virucida - Funghicida

Producto químico de la marca GRE, especial para uso en piscinas sobre suelo
 GRE brand chemicals, especially for use in above-ground pools
 Produits d'entretien de marque GRE, pour utilisation dans les piscines hors sol
 Chimica marchio GRE, in particolare per l'uso in piscine fuori terra



NEW



pH plus

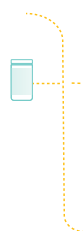

Ref. **20015**
 8412081240992
 1 Kg pack 12

Incrementador de pH - Granulado
 pH increase - Granules
 Augmente le pH - Granulés
 Incrementatore pH - Granulato

clorchoc



Ref. **20002**
 8412081240862
 1 Kg pack 12

Cloro choque - Pastillas 20 gr
 Shock chlorine - 20 gr tablets
 Chlore choc - Pastilles 20 gr
 Cloro Shock - Pastiglie 20g

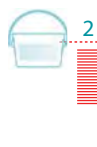

Ref. **20003**
 8412081240879
 2,5 Kg pack 4

Cloro choque - Pastillas 20 gr
 Shock chlorine - 20 gr tablets
 Chlore choc - Pastilles 20 gr
 Cloro Shock - Pastiglie 20g

pH minus

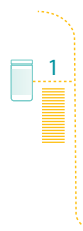

Ref. **20016**
 8412081241005
 1,5 Kg pack 12

Minorador de pH - Granulado
 pH reduce - Granules
 Baisse le pH - Granulés
 Riduttore pH - Granulato

Ref. **20014**
 8412081240985
 1,2 Kg pack 14

Kit piscinas infantiles
 Kit for children's pools
 Kit pour petit bassin
 Kit per piscine infantili

Cloro choque granulado 500 g + Algicida 500 ml
 Shock chlorine granules 500gr + Anti algae 500ml
 Chlore choc granulés 500gr + Anti-algues 500ml
 Cloro Shock granulato 500gr + Antialghe 500ml

Especial liner
Special liner
Spécial liner
Speciale liner



NEW



complet 4 actions

antialg



Ref. **20005**
 8412081240893
 1 Kg pack 12

Pastillas 20 gr
20 gr tablets
 Pastilles 20 gr
 Pastiglie 20g



Ref. **20011**
 8412081240954
 1 l pack 12

Antialgas
Anti algae
 Anti-algues
 Antialghe



Ref. **20006**
 8412081240909
 2,5 Kg pack 4

Tabletas 200 gr
200 gr tablets
 Galets 200 gr
 Pastiglie 200g



Ref. **20012**
 8412081240961
 3 l pack 4

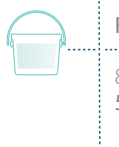

Ref. **20007**
 8412081240916
 5 Kg pack 4

floculant

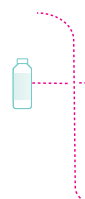

Ref. **20017**
 8412081241012
 1 l pack 12

Floculante líquido
Liquid flocculant
 Floculant liquide
 Floculante liquido



Cálculo de volumen de agua

Para un correcto suministro del producto químico, es importante calcular el volumen de agua de la piscina.

Calculate the pool water volume

It is important to calculate the pool water volume to do a correct chemical treatment.

Calcul de volume d'eau

Pour un bon dosage du produit chimique, il est nécessaire de calculer le volume d'eau de la piscine.

Calcolo del volume d'acqua

Per un corretto dosaggio del prodotto chimico è importante calcolare il volume d'acqua di una piscina.

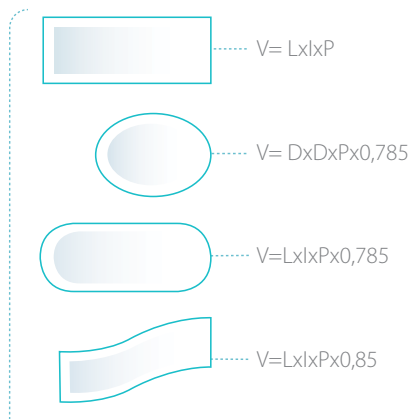

Ejemplo Example Exemple Esempio

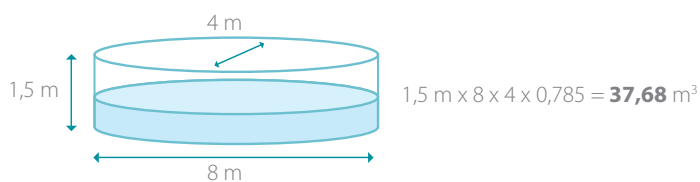

- V** Volumen en m³
Volume in m³
Volume en m³
Volume in m³
- L** Longitud en m
Length in m
Longueur en m
Lunghezza in m
- I** Anchura en m
Width in m
Largeur en m
Larghezza in m
- D** Diámetro en m
Diameter in m
Diamètre en m
Diametro in m
- P** Profundidad en m
Depth in m
Profondeur en m
Profondità media in m

Leyenda Legend Légende Legenda



1 Reguladores de pH

pH regulators

Régulateurs de pH

Correttori di pH



El pH indica la acidez o la basicidad del agua. En una piscina debe mantenerse ajustado entre los valores 7.2 y 7.6, ya que además de conservar las instalaciones en óptimas condiciones, es el ideal para la piel y los ojos de los bañistas.

pH shows if water is acid or basic. Pool water pH must be between 7.2 and 7.6, because it helps to conserve the equipment in good conditions and it is ideal for swimmer eyes and skin.

Le pH indique l'acidité ou la basicité de l'eau. L'eau de la piscine doit se maintenir entre les taux 7.2 et 7.6, car il aide à mieux conserver les installations et est l' idéal pour la peau et les yeux des baigneurs.

Il pH indica la acidità e la basicità dell'acqua. In una piscina il valore di riferimento deve essere sempre tra 7.2 e 7.6, dal momento che, oltre a favorire il trattamento chimico che viene effettuato, è il valore ideale affinché la pelle e gli occhi dei bagnanti non si irritino.



pH plus

 8427370 05914 8
1 Kg pack 12

Incrementador de pH
pH increase
Augmente le pH
Incrementatore pH

 8427370 05996 4
5 Kg pack 4

Incrementador de pH: para aumentar y estabilizar el pH
pH increase: to increase and stabilize pH
Augmente le pH: pour augmenter et stabiliser le pH
Per aumentare e stabilizzare il pH

pH minus

 8427370 05912 4
1.5 Kg pack 12

Minorador de pH
pH reduce
Baisse le pH
Riduttore pH

 8427370 05995 7
5 Kg pack 4

Minorador de pH: para bajar y estabilizar el pH
pH reduce: to lower and stabilize pH
Baisse le pH: pour baisser et stabiliser le pH
Per abbassare e stabilizzare il pH





2 Desinfectantes

3 Disinfectants

Désinfectants

Desinfettanti



Para poder tener un agua transparente y en definitiva libre de posibles contagios, es imprescindible que ésta sea desinfectada regularmente. Los desinfectantes pueden ser de diversos tipos, siendo los más comunes los productos clorados, aunque también existen otras soluciones alternativas, igualmente con un elevado poder desinfectante, como el bromo o el oxígeno activo.

In order to have clear water without contagious danger, it is necessary to treat it regularly. There exist several kind of disinfectants, whose most common is chlorine. Other solutions like bromine or oxygen have also a high disinfection action.

2 Cloro choque Shock chlorine

Chlore choc Cloro Shock

El Cloro Choque permite destruir rápida y eficazmente todos los organismos, hongos y bacterias. Conviene realizar una cloración de choque: Al inicio de la temporada de baño / Después de condiciones climáticas extremas / En caso de uso intensivo de la piscina. It eliminates quickly all the organisms and bacteria. It is necessary to do a Shock chloration: At the beginning of the swim season / After bad weather conditions / High use level.

Le Chlore Choc permet de détruire rapidement tous les organismes, champignons et bactéries. Il convient d'effectuer une chloration choc: Au début de la saison de baignade / Après des dures conditions climatiques / En cas d'usage intensif de la piscine.

Permette di eliminare rapidamente ed efficacemente tutti gli organismi, funghi e batteri. È utile usare questo tipo di prodotto: All'inizio della stagione / Dopo condizioni climatiche estreme / In caso di un uso intensivo della piscina.

Pour avoir une eau transparente et en définitive libre de contagions, il est indispensable que celle-ci soit traitée régulièrement. Il existe plusieurs sortes de désinfectants, le chlore étant le plus connu. Également, il y a d'autres solutions alternatives avec un haut pouvoir désinfectant, comme le brome ou l'oxygène actif.

Per avere un'acqua pulita e libera da ogni possibile contagio è indispensabile che quest'ultima sia disinfettata regolarmente. I disinfectanti più comuni sono a base di cloro, ma possono essere di diverso tipo dal momento che, esistono altre soluzioni alternative disinfectanti di pari valore, come per esempio l'ossigeno attivo e il bromo.



3ª Cloro lento Trichlorine

Chlore lent Cloro Lento

Para conseguir una desinfección preventiva y continua del agua, es necesario mantener una tasa de cloración libre. Por ello, conviene efectuar una cloración permanente o "cloración lenta".

To have a preventive and continue disinfection, it is necessary to keep a free chloration value. For this reason, people must do a permanent chloration or a "slow chloration".

Pour avoir une désinfection préventive et continue, il est nécessaire de maintenir un taux de chloration libre. Pour cette raison, il faut effectuer une chloration permanente ou « chloration lente ».

Per ottenere una disinfezione preventiva e continua dell'acqua, è necessario mantenere un valore di cloro "libero". Per questo è bene effettuare una clorazione continua o una "clorazione lenta".

clorchoc		
	8427370 08483 6 1 Kg pack 12	Pastillas 20 gr 20 gr tablets
	8427370 08484 3 5 Kg pack 4	Pastilles 20 gr Pastiglie 20g
	8427370 05201 9 5 Kg pack 42	1/2 box palet
Con un 50% de cloro activo mínimo (triclora) Disolución instantánea Minimum 50% active chlorine (trichlorine) Instant dissolution 50% chlore actif minimum (trichlore) Dissolution instantanée Minimum 50% available chlorine (trichlorine) Quick dissolution		
	8427370 05916 2 1 Kg pack 12	Granulado Granules
	8427370 05917 9 5 Kg pack 4	Granulés Granulato
Con un 55% de cloro activo mínimo. Disolución rápida Minimum 55% active chlorine. Quick dissolution 55% chlore actif minimum. Dissolution rapide Con un 55% di cloro minimo attivo. Dissoluzione rapida		

clorlent		
	8427370 05922 3 1 Kg pack 12	Tabletas 200 gr 200 gr tablets
	8427370 05923 0 5 Kg pack 4	Galets 200 gr Pastiglie da 200g
	8427370 05920 9 1 Kg pack 12	Granulado Granules
	8427370 05921 6 5 Kg pack 4	Granulés Granulato



3

4

3^b Bromo Bromine Brome Bromo

Diferencias respecto al cloro: menos olor, no daña la piel ni el cabello. Más eficacia en las aguas calientes y/o calcáreas.
Differences compared to chlorine: less smell, does not dry out skin and hair. More efficient in hot and/or calcareous water
Différences par rapport au chlore: moins d'odeur, ne dessèche pas la peau ni les cheveux. Plus efficace dans les eaux chaudes et/ou calcaires.
Differenze rispetto al cloro: meno odore, non danneggia la pelle né i capelli. Più effi cace con l'acqua molto calda e/o calcarea.

brom'lent		
	8427370 05531 7 1 Kg pack 12	Pastillas 20 gr 20 gr tablets Pastilles 20 gr Pastiglie 20g
	8427370 05526 3 5 Kg pack 4	
	8427370 05530 0 10 Kg pack 2	
brome choc		
	8427370 05508 9 5 Kg pack 4	Granulado Granules Granulés Granulato

Brom multiactions

	8427370 30198 8 5 Kg pack 4	Bromo multi-Acciones pastillas 20 gr Bromine multi-Actions 20 gr tablets Brome multi-Actions pastilles 20 gr Bromo multi funzioni pastiglie 20 gr
--	--------------------------------	--



5

6

3^c Oxígeno activo Active oxygen Oxigène actif Ossigeno attivo

Ofrece muchas ventajas, ya que proporciona una desinfección muy eficaz y a diferencia del cloro, no provoca irritaciones oculares ni desprende olores desagradables. Producto que necesita de un dosificador.
This product offers a lot of advantages. It disinfects pool water and contrary to chlorine, it does not cause eye irritation neither and bad smells. This product needs a dispenser.
Ce produit offre beaucoup d'avantages par rapport au chlore, car il ne provoque aucune irritation oculaire, ôte les mauvaises odeurs et en même temps fait une désinfection très efficace. Il a besoin d'un doseur. Offre molti vantaggi, dal momento che sviluppa una disinfezione molto efficace e, a differenza del cloro, non irrita gli occhi e non ha un odore sgradevole. E' un prodotto che necessita del dosatore.

acti oxy		
	8427370 05660 4 1 L pack 12	Activador O₂ y microbicida Active O₂ algacide Activateur O₂ et microbicide Attivatore O₂ e microbicida
	8427370 05936 0 5 L pack 4	
oxy choc		
	8427370 05938 4 5 L pack 4	Oxígeno choque Shock oxygen Oxygène choc Ossigeno shock
oxy lent		
	8427370 05937 7 1,2 Kg pack 12	O₂ activo · pastillas 20 gr O₂ oxygen · 20 gr tablets O₂ actif · pastilles 20 gr O₂ attivo · pastiglie da 20g
	8427370 05661 1 2,5 Kg pack 4	
	8427370 05935 3 5 Kg pack 4	



Multifunciones
Multiactions
Multi-actions
Multi funzioni



Se trata de un **producto revolucionario**, ya que gracias a su fórmula innovadora permite en una sola aplicación, eliminar las bacterias, virus y microorganismos en general, evitar el desarrollo de algas, al mismo tiempo que mantiene transparente y cristalina el agua.

Revolution product: Thanks to its new formula, you can eliminate bacteria, virus and micro organisms, avoid algae and have clear and crystalline water.

Il s'agit d'un **produit révolutionnaire**. Grâce à sa formule innovatrice, il permet avec une seule application, d'éliminer les bactéries, virus et microorganismes en général, d'éviter l'apparition d'algues, ainsi que de conserver l'eau transparente et cristalline.

Si tratta di un prodotto rivoluzionario proprio perché, grazie alla sua formula innovatrice, permette, in una sola applicazione, di eliminare i batteri, virus e tutti i microorganismi evitando il proliferare di alghe, mantenendo allo stesso tempo l'acqua trasparente e cristallina.



Complet 4 actions :

Cloro + Antialgas + Estabilizante + Floculante
Chlorine + Antialgae + Stabiliser + Flocculant
Chlore + Anti-algues + Stabilisant + Flocculant
Cloro + Antialghe + Stabilizzante + Floculante

complet 4 actions	
	8427370 07621 3 0,5 Kg pack 48 Bloque 500 gr – 1 bloque 500 gr block - 1 block Bloc 500 gr – 1 bloc 500g in un'unica pastiglia
	8427370 05520 1 1 Kg pack 12 Tabletas 200 gr 200 gr tablets Galets 200 gr Pastiglie da 200g
	8427370 06641 2 5 Kg pack 4
	8427370 05521 8 10 Kg pack 2
	8427370 05200 2 5 Kg pack 42 1/2 box palet
	8427370 05523 2 1 Kg pack 12 Pastillas 20 gr 20 gr tablets Pastilles 20 gr Pastiglie da 20g
	8427370 05524 9 5 Kg pack 4
	8427370 05522 5 5 Kg pack 4 Granulado Granules Granulés Granulato

complet 4 actions - special liner

	8427370 05662 8 1 Kg pack 12	Tabletas 200 gr 200 gr tablets Galets 200 gr Pastiglie da 200g
	8427370 05663 5 5 Kg pack 4	
	8427370 05664 2 10 Kg pack 2	
	Sin sulfato de cobre Without copper sulphate Sans sulfate de cuivre Senza solfato di rame	

Complet 5 actions

Cloro + Antialgas + Estabilizante + Floculante + Antical
Chlorine + Antialgae + Stabiliser + Flocculant + Anti lime
Chlore + Anti-algues + Stabilisant + Flocculant + Anti-calcaire
Cloro + Antialghe + Stabilizzante + Floculante + Anticalcare

	8427370 06640 5 5 Kg pack 4	Tabletas 200 gr 200 gr tablets Galets 200 gr Pastiglie da 200g
	8427370 06642 9 10 Kg pack 2	



Total 10 actions :

Desinfectante + Bactericida + Floculante + Coagulante + Algicida + Algistático + Regulador de pH + Estabilizante de cloro + Anticalcáreo + Viricida + Fungicida

Disinfectant+ Germicide + Flocculent + Coagulant + Algicide + Algistatic + pH regulator + Chlorine stabilizer + Anti-Limescale Agent + Virucide+ Fungicide

Désinfectant + Bactéricide + Floculant + Coagulant + Algicide + Algistatique + Régulateur de pH + Stabilisant de chlore + Anticalcaire + Virucide + Fongicide

Disinfettante + Battericida + Floculante + Coagulante + Algicida + Alghistatico + Regolatore del pH + Stabilizzante del cloro + Anticalcare + Virucida + Funghicida

complet 10 actions

3 8427370 05527 0 **Pastillas 250 gr 250 gr tablets**
2,5 Kg pack 4 **Pastilles 250 gr**
Pastiglie da 250gr

4 8427370 05525 6 **Pastillas 250 gr 250 gr tablets**
5 Kg pack 4 **Pastilles 250 gr**
Pastiglie da 250gr

Multifunciones bicapa
Two-layer multiactions
Multi-actions bicouche
Multi funzioni doppio strato



Multiactions + Choc

Cloro multifunción + choque
Multiactions + shock chlorine
Chlore multi-actions + choc
Cloro multi funzioni + shock

8427370 06646 7 **Pastillas bicapa 250 gr 250 gr Two-layer tablets**
1 Kg pack 6 **Pastilles bicouche 250 gr**
Pastiglie doppio strato da 250gr

8427370 05665 9
2,5 Kg pack 4

5 8427370 06643 6
5 Kg pack 4

Multiactions + Antical

Cloro multifunción + anticalcáreo
Multiactions + anti lime chlorine
Chlore multi-actions + anticalcaire
Cloro multi funzioni + anticalcare

6 8427370 06644 3 **Pastillas bicapa 250 gr 250 gr Two-layer tablets**
5 Kg pack 4 **Pastilles bicouche 250 gr**
Pastiglie doppio strato da 250gr



4 Tratamiento antialgas

Anti-algae treatment

Traitement anti-algues

Trattamento antialghe



Las algas son organismos vegetales unicelulares que pueden desarrollarse y multiplicarse rápidamente en el agua, sobre todo cuando su temperatura es templada.

Algae are vegetal unicellular organisms that can quickly develop and multiply themselves in the water, specially when the temperature of the water is warm.

Les algues sont des organismes végétaux unicellulaires qui peuvent apparaître et se multiplier très rapidement dans l'eau, surtout quand la température de l'eau est tempérée.

Le alghe sono organismi vegetali unicellulari che possono svilupparsi e moltiplicarsi soprattutto quando la temperatura dell'acqua è abbastanza calda.

stop eaux vertes



8427370 05510 2
5 L pack 4

Stop aguas verdes
Stop green waters
Stop eaux vertes
Stop acqua verdi

Oxígeno activo: acción sin cloro
Active oxygen: without chlorine
Oxygène actif: action sans chlore
Ossigeno attivo: azione senza cloro

antialg



8427370 05926 1
1 L pack 12

Antialgas
Anti algae
Anti-algues
Antialghe



1 8427370 05927 8
5 L pack 4

8427370 05202 6
5 L pack 48

1/2 box palet

Para prevenir la aparición de algas.
To prevent the appearance of algae
Pour prévenir l'apparition d'algues.
Per prevenire la comparsa delle alghe.

antialg xtra



8427370 05928 5
1 L pack 12

Antialgas Extra
Extra anti algae
Anti-algues Extra
Antialghe Extra



2 8427370 05929 2
5 L pack 4

3 acciones. Extra: para eliminar todas las algas.
3 actions. Extra: to eliminate the algae.
3 actions. Extra: pour éliminer la totalité des algues.
3 azioni. Extra. Per eliminare tutti i tipi di alghe

5 Floculante Flocculant Floculant Floculante



3



4



5



6

La floculación permite obtener un agua cristalina. Existen dos tipos de floculación: la que se realiza dentro del filtro y la floculación dentro del vaso. La primera permite aumentar la fineza de filtración y eliminar de esta manera las partículas más finas. Ésta se efectúa gracias a los cartuchos floculantes (incompatibles con filtros de cartucho) colocados en el cesto del skimmer. La segunda permite agrupar entre ellas las impurezas que no pueden ser filtradas individualmente y que son el origen de un agua turbia. Esta operación se efectúa con el floculante líquido.

Floculation allows to obtain a crystalline water. There are two kind of floculation: inside the filter and in the pool. With the first one we increase the fineness of filtration in order to eliminate smaller particles. For this process we introduce flocculants cartridges (incompatible with cartridge filters) in the skimmer basket. The second one helps us to group all the impurities that are the beginning of brown water thanks to liquid flocculant.

La floculation permet d'obtenir une eau cristalline. Il y a deux types de floculation : celle qui se fait dans le filtre et la floculation dans le bassin. La première permet d'augmenter la finesse de filtration et d'éliminer de cette façon les particules plus fines. S'effectue grâce aux cartouches floculantes (incompatibles avec les filtres à cartouche) dans le panier du skimmer. La deuxième permet de regrouper entre elles les impuretés qui ne peuvent pas être filtrées et qui sont l'origine des eaux troubles. Cette opération se fait avec le floculant liquide.

La floculation permette di ottenere un'acqua cristallina. Esistono due tipi di floculation: quella che si realizza all'interno del filtro e quella diluendo il prodotto in un contenitore. La prima permette di migliorare la filtrazione ed eliminare le particelle più fini e si effettua grazie alle cartucce floculanti (incompatibili con i filtri a cartuccia) poste dentro il cesto dello skimmer. La seconda permette di raggruppare tra loro le impurità che non possono essere filtrate individualmente e che sono la causa dell'acqua torbida. Questo procedimento si effettua con il floculante liquido.

super floculant



3

8427370 05666 6
200 gr pack 24

10 Tabletas de 20 gr
20 gr 10 tablets
10 Galets 20 gr
10 Pastiglie da 20g

Tabletas de floculante superconcentradas
Super-concentrated flocculant tablets
Tablettes de floculant super concentrées
Floculante in pastiglie superconcentrate



5

8427370 05932 2
1 L pack 12

floculant

Floculante líquido
Liquid flocculant
Floculant liquide
Floculante liquido



6

8427370 05933 9
5 L pack 4

Para clarificar el agua y eliminar las materias en suspensión. Recupera el agua turbia.
To clarify water and eliminate substances in suspension
Retrieve the cloudy water
Pour clarifier l'eau et éliminer les matières en suspension
Récupère l'eau trouble
Rende acqua cristallina ed elimina le particelle in superficie. Recupera l'acqua torbida



4

8427370 07445 5
1 Kg pack 14

Cartuchos floculantes 125g
Flocculant cartridges 125g
Cartouches floculantes 125g
Floculante a cartuccia 125g

Para mejorar la calidad de filtración (filtros de arena únicamente). Producto de mantenimiento.
To increase filtration quality (sand filters only). Product Maintenance.
Pour améliorer la qualité de filtration (filtres à sable uniquement). Produit de maintenance.
Per migliorare la qualità della filtrazione (solo per i filtri a sabbia). Prodotto di mantenimento.





Productos complementarios Complementary products
Produits complémentaires Prodotti complementari



desartrant surface

 8427370 08487 4
1 L pack 12
Desincrustante de superficie
Surface descaler
Détartrant de surface
Pulitore superfici d'acqua

 2 8427370 05930 8
5 L pack 4

 1 8427370 08490 4
1 L pack 12
Gel limpiador antical
Cleansing Anti-Limescale Gel
Gel nettoyant anti-calcaire
Gel pulente anticalcare

Para eliminar incrustaciones de cal
To eliminate lime scales
Pour éliminer les incrustations calcaires
Per evitare la incrostazione del calcare

 8427370 08491 1
6 kg pack 4
Neutralizador de cloro/bromo
Chlorine/bromine Neutralizer
Neutraliseur de chlore / brome
Neutralizzatore di cloro/bromo

Para eliminar el exceso de cloro/bromo residual
To eliminate the excess residual chlorine/bromine
Pour éliminer l'excès de chlore / brome résiduel
Per eliminare l'eccesso di cloro/bromo residuo

anticalc

 3 8427370 08488 1
1 L pack 12
Anticalcáreo
Anti lime
Anti-calcaire
Anticalcare

 8427370 08489 8
5 L pack 4

Para evitar la formación de cal.
Secuestrante de metales (hierro, cobre...)
To prevent lime formation.
Metal Sequestering Agents (iron, copper...)
Pour éviter la formation de calcaire.
Séquestrant de métaux (fer, cuivre, etc.)
Evita la formazione del calcare.
Sequestrante di metalli (ferro, rame)

nettoyant ligne d'eau

 8427370 05931 5
1 L pack 12
Limpiador de bordes
Waterline cleaner
Nettoyant ligne d'eau
Pulitore superfici d'acqua

Para eliminar la suciedad de la línea de flotación
To eliminate the dirt on the waterline
Pour éliminer la saleté sur la ligne d'eau
Per eliminare particelle in superficie

Producto químico para el invierno Chemical products for winter Produits chimiques pour l'hiver Prodotti chimici per l'inverno

Le facilitará la puesta en marcha de la piscina después del invierno, evitando la formación de algas y de cal.
Realizar el proceso cuando la temperatura del agua de la piscina sea inferior a 15°C.

- 1) Limpiar la piscina.
- 2) Ajustar el pH entre 7,2 - 7,6
- 3) Realizar una cloración de choque
- 4) Dejar en funcionamiento el filtro hasta el día siguiente 5)
- Realizar una limpieza del filtro
- 6) Añadir el invernador

It makes easier for you the start-up of the pool after winter, avoiding algae and lime formation.
Please carry out the following if the temperature of the water drops below 15°C.

- 1) Clean the swimming pool
- 2) Set the pH balance between 7.2 – 7.6
- 3) Carry out a chlorine crash course
- 4) Leave the filter running until the following day
- 5) Clean the filter
- 6) Add the winterizing agent

Vous facilite la mise en route de la piscine après l'hiver en évitant la formation d'algues et de calcaire.
Réaliser le processus lorsque la température de l'eau de la piscine est inférieure à 15°C.

- 1) Nettoyer la piscine
- 2) Ajuster le pH entre 7,2 - 7,6
- 3) Réaliser une chloration de choc
- 4) Laisser fonctionner le filtre jusqu'au lendemain
- 5) Nettoyer le filtre
- 6) Ajouter l'hivernant

Renderà più semplice l'inizio della nuova Stagione, dopo l'inverno, evitando la formazione di alghe e calcare.
Realizzare la procedura quando la temperatura dell'acqua della piscina è inferiore a 15°C.

- 1) Pulire la piscina
- 2) Regolare il pH tra 7,2 e 7,6
- 3) Effettuare una clorazione d'urto
- 4) Lasciare in funzione il filtro fino al giorno successivo
- 5) Effettuare una pulizia del filtro
- 6) Aggiungere lo svernante



hivernage	
 8427370 07446 2 1 L pack 12	Invernador Winteriser Hivernage Trattamento per l'inverno
 8427370 07449 3 5 L pack 4	

Hiver float	
 8427370 05528 7 2 kg pack 6	Invernador con boya Float winteriser Bouée hivernage Serra con boa



Parfums



8427370 90157 7
display 15 u.

Perfume para piscina
Botella de 250 ml
Pool perfume
250 ml bottle
Parfum pour piscine
Flacon de 250 ml
Profumo per piscina
Flacone da 250 ml

1 botella = 1 piscina de 50 m³
1 bottle = one for 50 m³ pool
1 flacon = bassin de 50m³
1 flacone = 1 piscina da 50 m³

Perfume para toda clase de piscinas
Perfuma la piscina y repele los insectos.
100% natural

Este perfume para el agua de la piscina es también un ambientador para las piscinas cubiertas. Respeta la acción de los productos de tratamiento del agua, además de no representar un peligro para el material técnico (bombas, filtros, etc.) Producto 100% a base de aceites naturales. Nuestros perfumes : Jazmín, Monoï, Vainilla, Lavanda, Marine

Perfume for all kind of pools
It perfumes the pool and repels the insects.
natural 100%

This perfume for pool water gives an appropriated atmosphere for covered pools. It respects the water chemical products action and it does not represent a danger for technical equipments (pumps, filters, etc) Made 100% from natural components.

Our perfumes: Jasmine, Monoï, Vanilla, Lavender, Marine

Parfum pour tout type de piscines
Parfume la piscine et éloigne les insectes.
100% naturel

Ce parfum pour eau de piscine est aussi un parfum d'ambiance pour les bassins couverts. Respecte l'action des produits pour le traitement de l'eau et ne représente pas de danger pour le matériel technique (pompes, filtrations, etc.) Produit 100% à base d'huiles naturelles Nos parfums : Jasmin, Monoï, Vanille, Lavande, Marine

Profumo per tutti i tipi di piscine.
Profuma la piscina e allontana gli insetti.
100% naturale

Questo profumo per l'acqua della piscina è anche un deodorante per le piscine coperte. Non contrasta l'azione dei prodotti chimici per il trattamento dell'acqua e non danneggia le parti che costituiscono la piscina (fi litri, sistema di filtrazione, ecc...). Prodotto 100% a base di oli naturali.

Profumazioni: Gelsomino, Monoï, Vaniglia, Lavanda, Marine.

nettoyant ligne d'eau



Jazmín / Lavanda / Monoï
Jasmine / Lavender / Monoï
Jasmin / Lavande / Monoï
Gelsomino / Lavanda / Monoï



PPA403
3760120043031
display 24 u.

Perfume piscina - caja de 3
pastillas de 40 gr.
Pool perfume
40g 3 tablet box
Parfum pour piscine carton
de 3 pastilles de 40g
Profumo per piscina
confezione di 3 pastiglie da
40g



NLA100
3760120430329
display 12 u.

Limpiador linea de
agua con aplicador
Waterline cleaner
with applicator
Nettoyant ligne d'eau
avec applicateur
Pulitore linea d'acqua
con applicatore

Anti insect



3760120430275
Cod. 90178
180 g pack 12

Caja de 6 pastillas de 30g
30g 6 tablet box
Boite carton de 6 pastilles de 30g
Confezioni di 6 pastiglie da 30g

Repulsivo Anti Insectos a base de aceites esenciales 100% naturales
Anti Insect repellent using 100% natural essential oils
Répulsif Anti Insectes à base d'huiles essentielles 100% naturelles
Repellente anti-insetti a base di oli essenziali 100% naturali



3760120430305
Cod. 90175
90 g pack 24

Dosificador de 3 pastillas de 30g
30 g 3 tablet dosifier
Doseur de 3 pastilles de 30g
Dosatore di 3 pastiglie da 30g

Repulsivo Anti Insectos a base de aceites esenciales 100% naturales
Anti Insect repellent using 100% natural essential oils
Répulsif Anti Insectes à base d'huiles essentielles 100% naturelles
Repellente anti-insetti a base di oli essenziali 100% naturali

Specific treatments



3760120430282
Cod. 90147
120g pack 12

Stop Aguas Verdes
Stop Green Waters
Stop Eaux Vertes
Stop Acqua Verdi

Recupera las aguas verdes gracias a una nueva generación de polimeros hidrosolubles
Get back the green waters of your pool thanks to a new generation of water soluble polymers
Il récupère les eaux vertes grâce à une nouvelle génération de polymères hydrosolubles
Recupera le acque verdi grazie ad una nuova generazione di polimeri idrosolubili



3760120430299
Cod. 90143
120g pack 12

Stop Aguas Turbias
Stop Cloudy Waters
Stop Eaux Troubles
Stop acque torbide

Recupera las aguas turbias, y consigue un agua limpia y cristalina
Get back the cloudy waters to obtain a crystal-clear water
Traite les eaux troubles, et rend l'eau propre et cristalline
Recupera le acque torbide, la sua efficacia permette di avere un'acqua limpida e cristallina



3760120430343
Cod. SATC6
120g pack 12

Stop Aguas Turbias
Stop Cloudy Waters
Stop Eaux Troubles
Stop acque torbide

Para piscinas con filtro de cartucho
For pools with cartridge filter
Pour les piscines avec filtre à cartouche
Per le piscine con filtro a cartuccia



Soluciones de tratamiento Treatment solutions Solutions de traitement Trattamenti vari



8427370 08730 1
pack 12

Kit para piscina de 0 a 5m³
Kit for 0-5m³ pool
Kit pour piscine de 0 à 5m³
Kit per piscine da 0 a 5 m³

Cloro lento pastillas de 5 g - 500 g + Dosificador + Pelota
Trichlorine 5g tablets - 500 g + Dispenser + Ball
Chlore lent pastilles de 5 g - 500 g + Doseur + Ballon
Cloro lento pastiglie da 5 g - 500g + dosatore + palla gonfiabile



8427370 08731 8
pack 6

Kit para piscina de 5 a 15m³
Kit for 5-15m³ pool
Kit per piscine da 5 a 15 m³
Kit pour piscine de 5 à 15m³

Multifunciones pastillas 20g - 1Kg + Dosificador + Termómetro +
Analizador + Manguitos + Kit reparación liner
Multiactions 20g tablets - 1Kg + Dispenser + Thermometer + Test kit
+ Arm-bands + Liner repair kit
Multifonction pastilles 20g - 1 kg + Doseur + Thermomètre + Trousse
d'analyse + Brassards + Kit réparation liner
4 azioni pastiglie da 20g - formato 1 Kg + dosatore + termometro
+ kit analisi + bracciali + kit riparazione liner



8427370 08732 5
pack 4

Kit para piscina de 15 a 30m³
Kit for 15-30m³ pool
Kit pour piscine de 15 à 30m³
Kit per piscine da 15 a 30m³

Multifunciones pastillas 20g - 2.5Kg + Cloro choque granulado
2,5 Kg + Termómetro + Analizador
Multiactions 20g tablets - 1Kg + Shock chlorine granules - 2,5Kg
+ Dispenser + Thermometer
Multifonction pastilles 20g - 2.5 kg + Chlore choc granulés - 2.5 kg
+ Doseur + Thermomètre + Trousse d'analyse
4 azioni pastiglie da 20g - 2.5 Kg + Cloro Shock granulare -
2.5Kg + Dosatore + Termometro + Kit analisi



8412081241890
KITSPA
pack 2

Kit para Spa
Kit for Spa
Kit pour Spa
Kit per Spa

Oxígeno tabletas 20gr (1kg) + Minorador de pH granulado (1,5kg)
+ Antiespumante (500ml) + Algicida no espumante (1l)
+ Anticalcáreo (500ml) + Estuche analizador Cl/Br/Ox/pH
Oxygen 20gr tablets (1kg) + pH reduce granules (1,5kg)
+ Antifoam (500ml) + Non-foaming algacide (1l)
+ Anti lime (500ml) + Cl/Br/Ox/pH test kit
Oxygène galets 20gr (1kg) + Baisse le pH granulés (1,5kg)
+ Antimousse (500ml) + Algicide non moussant (1l)
+ Anti-calcaire (500ml) + Trousse de Cl/Br/Ox/pH
Ossigeno pastiglie da 20gr (1kg) + Riduttore pH granulato (1,5kg)
+ Antischiuma (500ml) + Non schiumogeno algicida (1l)
+ Anticalcare (500ml) + Kit analisi Cl/Br/Ox/pH



8427370 08012 8
pack 16

POOLP'O 0-10 m³
(250g)



8427370 08013 5
pack 16

POOLP'O 10-20 m³
(500g)

- Solución de tratamiento "Todo en Uno". Ideal piscinas elevadas con o sin filtración. Tratamiento mensual.
- 4 Acciones: Desinfectante, Antibacterias, Antialgas y Floculante
- No hay manipulación directa de producto químico. No perjudica la filtración gracias a su forma optimizada que deja el circuito de agua intacto. El POOLP'O sube a la superficie una vez acabado el producto químico, avisando de la necesidad de empezar un nuevo tratamiento.

- Treatment solution "All in One" for Above ground Pools with and without filtration. Monthly treatment.
- 4 actions: Disinfecting, Anti-bacteria, Anti-algae and Flocculant.
- No direct handling of chemical product. It does not obstruct filtration thanks to its form optimized – which leaves the circuit of water intact. It goes up once product finished, so you know you should start a new treatment.

- Solution de traitement "Tout en Un". Idéal pour piscines hors-sol avec ou sans filtration. Traitement mensuel.
- 4 Actions: Désinfectant, Anti-bactéries, Anti-algues, Flocculant.
- Pas de manipulation directe de produit chimique. Ne gêne pas la filtration grâce à sa forme optimisée qui laisse le circuit de l'eau intact. Ne gêne pas le volet du skimmer de part sa petite taille. Le POOLP'O remonte à la surface une fois le produit consommé vous avisant de la nécessité de recommencer un traitement.

- Soluzione "Tutto in uno". Adatto per piscine fuori terra con o senza filtrazione. Trattamento mensile
- 4 azioni: Disinfettante, Anti-batteri, Antialghe e Flocculante
- Non c'è contatto diretto con il prodotto chimico. Non danneggia la filtrazione grazie alla sua forma che lascia libero il circuito dell'acqua. El Poolp'ò sale in superficie una volta terminato il prodotto chimico, avisando della necessità di dover iniziare un nuovo trattamento.



Analizadores Test kits Trousses d'analyse Kit test



Ref. 40060
DIS 3/8 BL pack 24

Analizador de cloro/bromo + pH (Oto/Phenol)
Test kit chlorine/bromine + pH (Oto/Phenol)
Trousse chlore/brome + pH (Oto/Phénol)
Kit analisi cloro/bromo + pH (oto/Phenol)



400605



Ref. 40061
DIS 1/8 BL pack 24

Recambio Oto/Phenol
Refill Oto/Phenol
Recharge Oto/Phénol
Ricambio Oto/Phenol



400612



Ref. 40062
DIS 1/8 CS pack 24

Comparador cloro + pH - pastillas DPD1
Test kit chlorine + pH - DPD1 tablets
Trousse chlore + pH - pastilles DPD1
Kit analisi cloro + pH - pastiglie DPD1



400629



Ref. 40063
DIS 1/8 BL pack 24

Recambio pastillas DPD1
Refill DPD1 tablets
Recharge pastilles DPD1
Ricarica pastiglie DPD1



400636



Ref. 40066
DIS 1/8 CS pack 24

Kit de análisis de oxígeno/bromo + pH - pastillas DPD4
oxygen / bromine + pH test kit - DPD4 tablets
Trousse de oxygène/brome + pH pastilles DPD4
Kit analisi ossigeno/bromo + pH - pastiglie DPD4



400667



Ref. 40067
DIS 1/8 BL pack 24

Recambio pastillas DPD4
Refill DPD4 tablets
Recharge pastilles DPD4
Ricarica pastiglie DPD4



400674



Ref. TD61
CS pack 8

Tester digital de 6 lecturas: pH, Cloro libre, Salinidad, TDS (Tasa total de solidos disueltos en el agua), ORP, Temperatura
 6 readings digital tester: pH, FC (free chlorine), Salinity, TDS (Total disolve solids), ORP, Temperature
 Testeur digital 6 lectures: pH, Chlore libre, Salinité, TDS (total des solides dissous taux dans l'eau), ORP, Température
 Tester digitale 6 lettura: pH, Cloro libero, Salinità, TDS (totale di solidi disciolti tasso in acqua), ORP, Temperatura



Ref. 90335
CS pack 12

Kit de análisis digital de pH + termómetro
 pH digital test kit + thermometer
 Testeur digital de pH + Thermomètre
 Tester digitale di pH e Termometro



Ref. 90336
CS pack 12

Kit de análisis digital de cloro, bromo y oxígeno activo por método ORP/Redox
 Chlorine, bromine and active oxygen digital test kit by ORP/Redox method + thermometer
 Testeur digital de Chlore, Brome et oxygène actif par méthode ORP/Redox
 Tester digitale di cloro, bromo e ossigeno attivo con metodo ORP/Redox



Ref. 90337
BL pack 10

Recambio de solución de calibración de pH para referencia: 90335
 Refill pH calibration solution for reference: 90335
 Recharge de solution de calibrage de pH pour référence: 90335
 Ricarica di soluzione di calibratura di pH per riferimento: 90335



Tiras de análisis Test strips Languettes d'analyse Cartine tornasole



Ref. 40068
DIS 1/8 BL pack 16

Análisis cloro + pH + alcalinidad (50 tiras)
 Chlorine + pH + alkalinity analysis (50 strips)
 Analyse chlore + pH + alcalinité (50 languettes)
 Analisi cloro + pH + alcalinità



Ref. 40069
DIS 1/8 BL pack 16

Analiza el nivel de sal en agua
 Salt level in water analysis
 Analyse le niveau de Sel de l'eau
 Analiza el nivel de sal en agua



Material PLV - POS Material - Matériels PLV - Materiale POS



Tripticos Leaflets Dépliants Volantini

NEW www.gre.es



- ➔ [PÁGINA DE INICIO - PRODUCTOS MÁS VENDIDOS - PRODUCTOS MÁS VISITADOS - NOVEDADES - CATÁLOGO...](#)
- [HOME PAGE - MOST SOLD PRODUCTS - MOST VISITED PRODUCTS - NEW PRODUCTS - CATALOGUE...](#)
- [PAGE DE DÉMARRAGE - PRODUITS LES PLUS VENDUS - PRODUITS LES PLUS VISITÉS - NOUVEAUTÉS - CATALOGUE...](#)
- [HOME PAGE: - PRODOTTI ELENCATI - PRODOTTI PIÙ VISITATI - NOVITÀ - CATALOGO...](#)

- CONCURSO PISCINAS** ➔
- ¡ENVÍA TU FOTO!**
- POOL COMPETITION**
- SEND YOUR PHOTOS!**
- CONCOURS PISCINES**
- ENVOYEZ VOTRE PHOTO !**
- SUSSIDO PISCINE**
- INVIACI LA TUA FOTO**

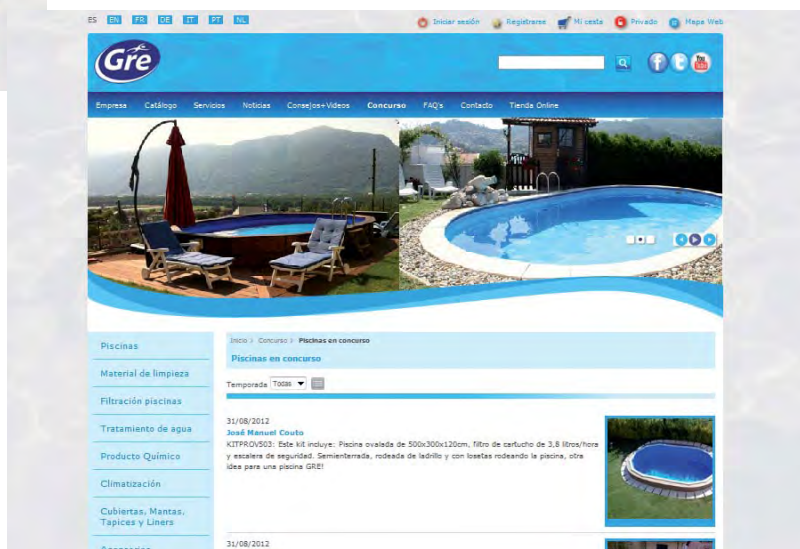



Nos reservamos el derecho de cambiar total o parcialmente las características de nuestros artículos o el contenido de este documento sin previo aviso
Fotos e imágenes no contractuales

We reserve the right to change all or part of the articles or contents of this document without prior notice
Photos and pictures are not contractual

Nous nous réservons le droit de modifier totalment ou en partie les caractéristiques de nos articles ou le contenu de ce document sans préavis
Photos et images non contractuelles

Ci riserviamo il diritto di cambiare totalmente o parzialmente le caratteristiche tecniche dei nostri prodotti ed il contenuto di questo documento senza nessun preavviso
La Fotografia o il disegno è solo a scopo illustrativo ed informativo



MANUFACTURAS GRE S.A.

ARITZ BIDEA Nº57 I BELAKO INDUSTRIALDEA
APARTADO 69 I 48100 MUNGIA (VIZCAYA) SPAIN
TLF: (34) 946 741 116
FAX: (34) 946 741 708
email: gre@gre.es

www.gre.es