

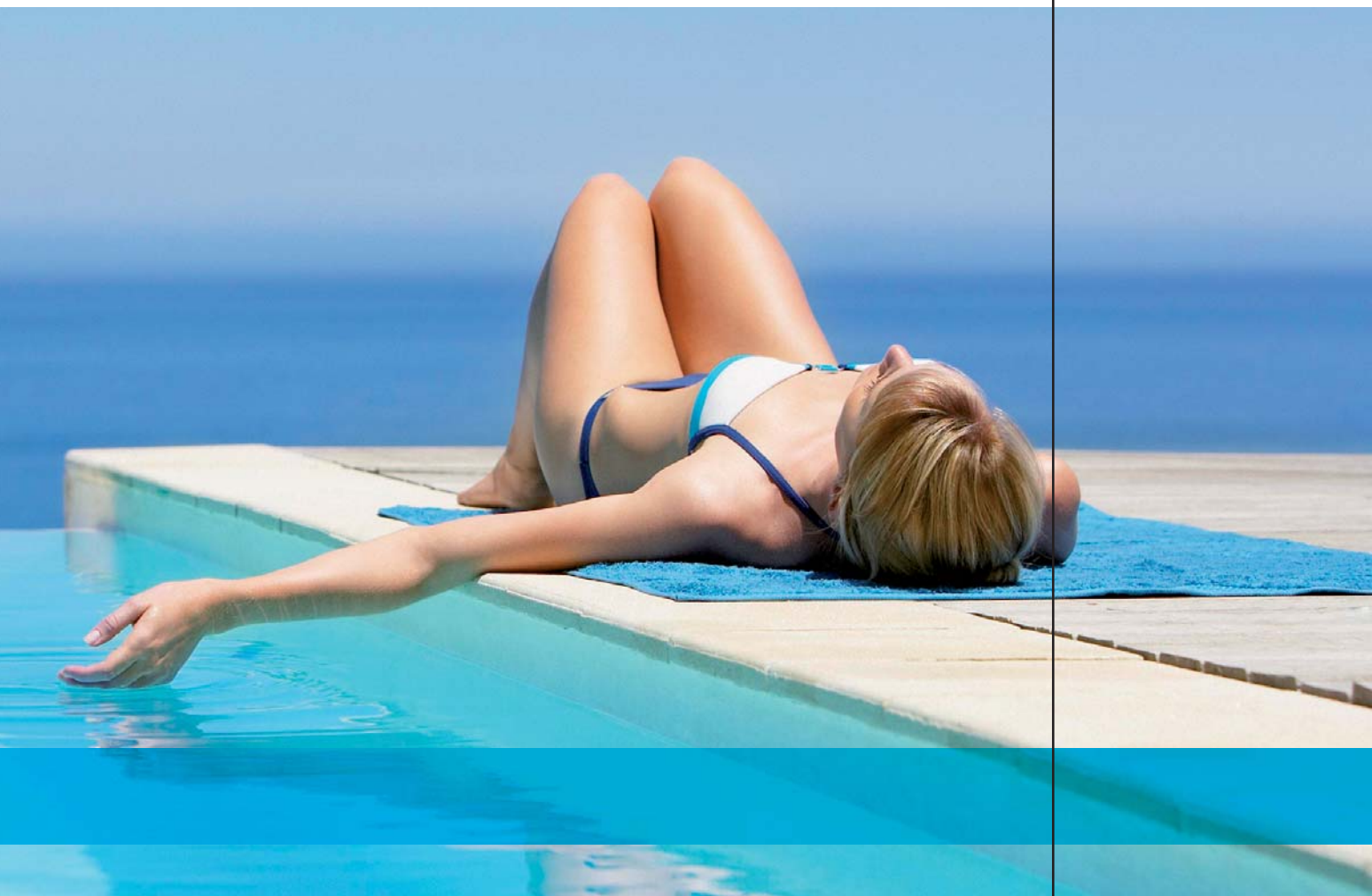







# Pools





Pools

# índice index sommaire indice

INTRODUCCIÓN INTRODUCTION INTRODUCTION INTRODUZIONE		Pag. <b>02</b>
PISCINAS ENTERRADAS IN-GROUND POOLS PISCINE ENTERRÉ PISCINE INTERRATA		Pag. <b>06</b>
PISCINAS DE MADERA WOODEN POOL PISCINE BOIS PISCINA IN LEGNO		Pag. <b>12</b>
PISCINAS DE ACERO STEEL WALL POOLS PISCINES PAROI ACIER PISCINA IN ACCIAIO		Pag. <b>18</b>
PISCINAS INFANTILES CHILDREN POOLS PISCINES POUR ENFANTS PISCINE PER BAMBINI		Pag. <b>60</b>
COMPLEMENTOS COMPLEMENTS COMPLEMENTS COMPLEMENTI		Pag. <b>62</b>
MATERIAL DE LIMPIEZA CLEANING MATERIAL MATÉRIEL DE NETTOYAGE MATERIALE DI PULIZIA		Pag. <b>92</b>
PRODUCTO QUÍMICO CHEMICALS PRODUITS D'ENTRETIEN CHIMICI		Pag. <b>114</b>

PISCINAS POOLS PISCINES PISCINAS



ENTERRADAS IN-GROUND ENTERRÉ INTERRATA



SOBRE SUELO ON-GROUND HORS SOL FUORI TERRA



TOLDO PROTECTOR POOL HOUSE  
AUVENT DE PROTECTION GAZEBO PER PISCINE

ESCALERA  
LADDER  
ÉCHELLE  
SCALA



MONOBLOCS DE FILTRACIÓN FILTRATION KITS  
KITS DE FILTRATION FILTRO MONOBLOCCO



CONTROLADOR DE PH CON BOMBA PERISTÁLTICA  
PH-CONTROL DOSING SYSTEM  
CONTRÔLEUR DE PH AVEC POMPE PÉRISTALTIQUE  
REGOLATORE DI PH CON POMPA PERISTALTICA



PROYECTORES PROJECTORS PROJECTEURS PROIETTORI

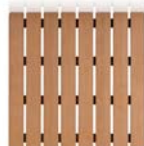

DUCHAS SHOWERS  
DOUCHES DOCCIA



WATER LILY



PRODUCTO QUÍMICO  
CHEMICALS  
PRODUITS D'ENTRETIEN  
PRODOTTI CHIMICI



MATERIAL DE LIMPIEZA CLEANING MATERIAL  
MATERIALE DI NETTOYAGE MATERIALE DI PULIZIA





## Presentación de la empresa

Gre es una empresa con más de 50 años de experiencia en la fabricación de piscinas elevadas.

Como empresa pionera en el sector, somos especialistas y líderes a nivel europeo.

Nuestra apuesta clara por la calidad y seguridad de todos nuestros productos, nos convierte en la referencia fundamental del mercado.

Nuestra empresa ofrece una amplia gama de productos: piscinas elevadas de diferentes formatos y acabados, una completa línea de accesorios para su equipamiento y mantenimiento y una serie de productos químicos diseñados específicamente para el agua de la piscina.

Con el ánimo siempre, de satisfacer al cliente, Gre ha diseñado una estrategia de servicios, cuyo objetivo es ofrecer una solución integral. Nuestra amplia red de Servicios Técnicos, así como nuestros Departamentos de Atención al Cliente, son la mejor prueba de ello. Estos servicios nos permiten asesorarle sobre la opción de piscina y equipamiento más adecuados a sus necesidades.

## Présentation de l'entreprise

Gré est une société spécialisée dans la fabrication de piscines hors-sol.

Pionnière dans le secteur, notre entreprise est SPÉCIALISTE et LEADER en EUROPE.

Notre pari sur la QUALITÉ et la SÉCURITÉ de tous nos produits nous permet d'être la principale RÉFÉRENCE du marché.

Notre entreprise offre une LARGE GAMME de produits, allant des piscines hors-sol aux tailles et finitions diverses et variées, jusqu'à un éventail complet des accessoires nécessaires à l'équipement et à l'entretien, et une gamme de produits chimiques conçus spécifiquement pour l'eau de la piscine.

Toujours dans le but de satisfaire le client, Gre a conçu une stratégie de SERVICES dont l'objectif est d'offrir une réponse et une solution complètes: un important réseau de Services Techniques ainsi qu'un Service Clients. Ces services nous permettent de vous conseiller sur le choix tant de votre piscine que de l'équipement le plus approprié à vos besoins.

## Company presentation

Gre is a company with more than 50 years experience in manufacturing above-ground pools.

As a pioneer company on its field, we are SPECIALISTS and LEADERS within the European market.

We are considered to be a fundamental market REFERENCE as a result of our clear wager on QUALITY and SECURITY of all our products.

Our company offers a WIDE RANGE of products which includes: different sizes and finishes aboveground pools, a complete range of accessories for their equipment and maintenance and a number of swimming pool chemicals designed specifically for the pool water.

Bearing in mind our customers satisfaction, Gre has designed an important SERVICES strategy whose aim is to offer an integral solution. Our wide network of Technical Services and our Customer Service Departments are the best proof of that. These services help us to identify our customers needs and to advice them on the best pool and equipment according to those needs.

## Presentazione dell'azienda

La Gre è un'azienda con oltre 50 anni di esperienza nella produzione di piscine smontabili su terra.

Come impresa pioniera nel settore, siamo SPECIALISTI e LEADER a livello EUROPEO.

La nostra chiara scommessa sulla QUALITÀ e sulla SICUREZZA di tutti i nostri prodotti, fa di noi il RIFERIMENTO fondamentale del mercato.

La nostra società offre una VASTA GAMMA di prodotti: piscine elevate di diversi formati e rifiniture, una completa linea di accessori per l'attrezzatura e la manutenzione e una serie di prodotti chimici pensati specificamente per l'acqua della piscina.

Sempre con l'intenzione di soddisfare il cliente, la Gre ha progettato una strategia di SERVIZI il cui scopo è quello di offrire una soluzione integrale. La nostra vasta rete di Servizi Tecnici, così come i nostri Reparti di Servizio al Cliente, ne sono la miglior prova. Tali servizi ci consentono di dare consulenza sulla scelta della piscina e dell'equipaggiamento più idoneo alle vostre necessità.

# Certificaciones Certifications Certifications Certificazioni

## MADE IN EUROPE

Todas las piscinas fabricadas por Manufacturas GRE S.A. Son de origen CE - Comunidad Europea.

Toutes les piscines fabriquées par Manufacturas Gre S.A. sont d'Origine CE - Communauté Européenne.

All the pools manufactured by Manufacturas Gre S.A. are of EC - European Community origin.

Tutte le piscine prodotte da Manufacturas Gre S.A. sono di origine CE - Comunità Europea.



## ISO 9001

Les processus utilisés pour la conception, la fabrication et la commercialisation de piscines hors-sol de Manufacturas Gre S.A., ainsi que la commercialisation de produits associés, sont certifiés conformes aux critères de système de Gestion de Qualité selon la norme internationale ISO9001:2000.

Los procesos utilizados para el diseño, la fabricación y comercialización de piscinas desmontables de Manufacturas Gre S.A., así como la comercialización de productos asociados, están certificados siguiendo los criterios de sistema de Gestión de Calidad según la norma internacional ISO9001:2000, lo cual garantiza regularidad y control en la calidad de nuestros productos y procesos.

The processes used for the design, manufacturing and commercialisation of dismountable pools by Manufacturas Gre S.A., as well as the commercialisation of associated products, are certified according to the Quality System according to the international ISO9001:2000 standard, which guarantees regularity and control in the quality of our products and processes.

I processi utilizzati per la progettazione, la costruzione e la vendita di piscine smontabili a marchio Manufacturas Gre S.A., oltre alla vendita di prodotti ad esse associati, sono certificati in base ai criteri del sistema di Gestione della Qualità secondo la norma internazionale ISO9001:2000, ciò garantisce la regolarità e il controllo della qualità dei nostri prodotti e dei processi produttivi.



## ISO 14001

Gracias a la implantación de un Sistema de Gestión Ambiental según la norma internacional ISO 14001:2004, Manufacturas Gre S.A. se posiciona como una empresa socialmente responsable. Entre otras ventajas ambientales, optimizamos la gestión de recursos y residuos, reduciendo los impactos ambientales negativos derivados de nuestra actividad o aquellos riesgos asociados a situaciones accidentales.

Grâce à l'implémentation d'un Système de Gestion Environnementale conformément à la norme internationale ISO 14001:2004, Manufacturas Gre S.A. se positionne comme une entreprise socialement responsable. Parmi de nombreux avantages environnementaux, nous optimisons la gestion des ressources et des déchets, réduisant ainsi les impacts environnementaux négatifs et dérivés de notre activité ou les risques associés à des situations d'accidents.

Thanks to the implantation of an Environmental Management System according to the international ISO 14001:2004 standard, Manufacturas Gre S.A. is positioned as a socially responsible company. Among other environmental advantages, we optimise resources and residues, reducing negative environmental impact derived from our activity or those risks associated to accidental situations.

Grazie all'introduzione di un Sistema di Gestione Ambientale secondo la norma internazionale ISO 14001:2004, Manufacturas Gre S.A. si classifica tra le aziende socialmente responsabili. Ciò comporta vantaggi per l'ambiente come l'ottimizzazione della gestione delle risorse, la riduzione degli impatti ambientali negativi derivanti dall'attività di produzione o dei rischi associati a eventi accidentali.



## ARBITRAJE DE CONSUMO / CONSUMER ARBITRATION / ARBITRAGE DE CONSOMMATION / ARBITRATO DI CONSUMO

Manufacturas Gre S.A. está adherido a la Junta Arbitral de Consumo como muestra de predisposición a la solución amistosa de cualquier tipo de reclamación por parte de sus clientes.

Manufacturas Gre S.A. est membre du bureau d'Arbitrage de Consommation, comme preuve de prédisposition à la solution amiable de tout type de réclamation de la part de ses clients.

Manufacturas Gre S.A. is adhered to the Consumer Arbitration Directorate evidencing predisposition to a friendly solution to any type of reclamation from its clients.

Manufacturas Gre S.A. aderisce alla Giunta Arbitrale di Consumo come segnale di predisposizione alla soluzione amichevole di qualsiasi tipo di reclamo da parte dei propri clienti.



## CE

Los productos distribuidos por Manufacturas Gre S.A. con el marcado CE cumplen todos los requisitos legales vigentes en Europa.

Les produits distribués par Manufacturas Gre S.A. dotés du marquage CE répondent à toutes les obligations légales en vigueur en Europe.

The products distributed by Manufacturas Gre S.A., with the CE marking comply with all the legal requirements in force in Europe.

I prodotti distribuiti da Manufacturas Gre S.A. con il marchio CE rispettano tutti i requisiti legali vigenti in Europa.





**NF P 90 - 303, NF P 90 - 316, NF P 90 - 317, NF P 90 - 318, NF P 90 - 319**

Estas certificaciones garantizan que las piscinas, filtros y escaleras fabricados y/o distribuidos por Manufacturas Gre S.A. cumplen con las normativas de seguridad establecidas.

These certifications guarantee that the pools, filters and stepladders manufactured and/or commercialised by Manufacturas Gre S.A. comply with the established safety regulations.

Ces certifications garantissent que les piscines, les filtres et les échelles fabriqués et/ou distribués par Manufacturas Gre S.A. respectent les normes de sécurité établies.

Queste certificazioni garantiscono che le piscine, i filtri e le scalette prodotti e/o distribuiti da Manufacturas Gre S.A. rispettano le normative di sicurezza previste.



**ECOEMBES**

Manufacturas Gre S.A. está adherida a un sistema de recogida y reciclaje selectivo de los materiales que pone en el mercado con el fin último de preservar el medio ambiente.

Manufacturas Gre S.A. is adhered to a system for the selective collection and recycling of the materials it puts on the market in order to conserve the environment.

Manufacturas Gre S.A. est membre d'un système de collecte et de recyclage sélectif des matériaux qu'elle met sur le marché, dans le but de préserver l'environnement.

Manufacturas Gre S.A. aderisce a un sistema di raccolta differenziata e riciclaggio dei materiali immessi sul mercato, in un'ottica di preservazione dell'ambiente.



**REACH**

Manufacturas Gre S.A. cumple con el reglamento Reach asegurando que todas las sustancias químicas que comercializa están registradas.

Manufacturas Gre S.A. complies with the Reach regulation ensuring that all the chemical substances it commercialises are registered.

Manufacturas Gre S.A. respecte le règlement Reach, qui garantit que toutes les substances chimiques qu'elle commercialise sont enregistrées.

Manufacturas Gre S.A. rispetta il regolamento Reach garantendo la registrazione di tutte le sostanze chimiche immesse sul mercato dall'azienda.

**RoHS**

**ROHS**

Manufacturas Gre S.A. cumple esta directiva para proteger el medio ambiente y la salud de las personas, evitando el uso de determinadas sustancias en aparatos eléctricos y electrónicos.

Manufacturas Gre S.A. complies with this directive to protect the environment and health of persons, avoiding the use of determined substances in electrical and electronic devices.

Manufacturas Gre S.A. respecte cette directive afin de protéger l'environnement et la santé des personnes, évitant ainsi l'utilisation de substances déterminées dans les appareils électriques et électroniques.

Manufacturas Gre S.A. rispetta questa normativa per proteggere l'ambiente e la salute delle persone, evitando l'utilizzo di determinate sostanze su dispositivi elettrici ed elettronici.



**PEFC**

Manufacturas Gre S.A. cumple con los requisitos del Estándar de Cadena de Custodia de Productos Forestales PEFC ST 2002:2010

Manufacturas Gre S.A. complies with the requirements of the Programme for the Endorsement of Forest Certification PEFC ST 2002:2010

Manufacturas Gre S.A. respecte les conditions du Standard de la Chaîne de Contrôle de Produits Forestiers PEFC ST 2002:2010.

Manufacturas Gre S.A. rispetta i requisiti previsti dallo Standard della catena di custodia dei prodotti forestali PEFC ST 2002:2010.





# in-ground pool

## PISCINA ENTERRADA DE PARED DE ACERO

**LINER:** Tratamiento Anti-ultravioleta que retrasa el envejecimiento del P.V.C.

**CHAPA:** Laminada en frío con tratamiento de galvanización, fosfatación e imprimación.

Troquelada para skimmer, válvulas de retorno y limpiafondos y focos.

## PISCINE ENTÉRÉE PAROI ACIER

**LINER:** Traitement anti-ultraviolets contre le vieillissement du P.V.C.

**TÔLE:** Tôle laminée à froid et traitée par galvanisation, phosphatage, couche d'apprêt et laquage.

Découpage pour le skimmer, la buse de refoulement et la prise balai. Prédécoupe pour les projecteurs.

## IN-GROUND STEEL WALL POOL

**LINER:** Anti-ultraviolet treatment to slow down P.V.C aging.

**PLATE:** Galvanized, phosphatized, primed and lacquered cold-rolled plate.

Die cut for skimmer, return valve and cleaner openings and lights.

## PISCINE INTERRATA CON PARETI IN ACCIAIO

**LINER:** Trattamento Anti-ultravioletti - Ritarda l'invecchiamento del P.V.C.

**PANNELLO:** Laminata a freddo con trattamento di galvanizzazione, fosfatazione e preparazione.

Stampigliatura per Skimmer, valvola di ritorno e puliscifondi e spot.



**MADE  
IN  
EU**

in-ground pool

serie

# MADAGASCAR



	800x470 cm	730x375 cm	610x375 cm	500x300 cm	150 cm	40.140 l	29.225 l	24.420 l	16.015 l	471 kg	466 kg	453 kg	413 kg	1/120x80	10m <sup>3</sup> /h	10m <sup>3</sup> /h	10m <sup>3</sup> /h	8m <sup>3</sup> /h	√	√	√	√	258874	258881	258898	258904	
KPEOV8159																											
KPEOV7359																											
KPEOV6159																											
KPEOV5059																											



MEDIDA PISCINA  
POOL SIZE  
DIMENSIONS PISCINE  
MISURA PISCINA

ESPACIO NECESARIO  
NECESSARY SPACE  
ESPACE NECESSAIRE  
SPAZIO NECESSARIO

	MEDIDA PISCINA POOL SIZE DIMENSIONS PISCINE MISURA PISCINA	ESPACIO NECESARIO NECESSARY SPACE ESPACE NECESSAIRE SPAZIO NECESSARIO
KPEOV8159	800x470x150 cm	1010x670x165 cm
KPEOV7359	730x375x150 cm	930x575x165 cm
KPEOV6159	610x375x150 cm	810x575x165 cm
KPEOV5059	500x300x150 cm	700x500x165 cm



Liner PVC azul  
75/100  
PVC blue liner  
75/100  
Liner bleu PVC  
75/100  
Liner blu PVC  
75/100

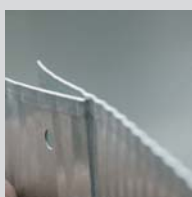

Chapa prelacada  
70/100  
Prelacquered steel  
70/100  
Tôle prélaquée  
70/100  
Lamiera laccata  
70/100



Depuradora arena  
(Caudal grupo 10/8 m<sup>3</sup>/h)  
Sand filter  
(Flow group 10/8 m<sup>3</sup>/h)  
Filtre à sable  
(Débit groupe 10/8 m<sup>3</sup>/h)  
Filtro a sabbia  
(Portata gruppo 10/8 m<sup>3</sup>/h)



KPE4559	Ø460 cm	150 cm	22.590 l	265 kg	1/90x80	8m <sup>3</sup> /h	√	258911
---------	---------	--------	----------	--------	---------	--------------------	---	--------

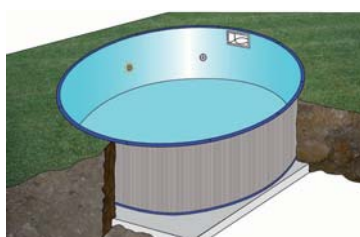

MEDIDA PISCINA  
POOL SIZE  
DIMENSIONS PISCINE  
MISURA PISCINA

ESPACIO NECESARIO  
NECESSARY SPACE  
ESPACE NECESSAIRE  
SPAZIO NECESSARIO

KPE4559

Ø460x150 cm

Ø660x165 cm



Escalera:  
4 peldaños - Inox.  
Ladder:  
4 steps - Stainless steel  
Echelle:  
4 marches - Acier inoxydable  
Scala:  
4 gradini - Inox



Manta protectora  
(Poliéster)  
Bottom protectiveblanket  
(Polyester)  
Tapis de sol en feutre  
(Polyester)  
Telo di protezione  
(Poliestere)



Skimmer, manguera,  
racordería...  
Skimmer, hose,  
fittings...  
Skimmer, tuyau,  
raccords...  
Skimmer, tubo,  
racordería...

in-ground pool

serie

SUMATRA



	800x470 cm	730x375 cm	610x375 cm	500x300 cm	120 cm	30.990 l	22.560 l	18.855 l	12.360 l	456 kg	446 kg	436 kg	396 kg	1/120x80	10m³/h	10m³/h	10m³/h	8m³/h	√	√	√	√	258928	258935	258942	258959		
KPEOV8127																												
KPEOV7327																												
KPEOV6127																												
KPEOV5027																												



MEDIDA PISCINA  
POOL SIZE  
DIMENSIONS PISCINE  
MISURA PISCINA

ESPACIO NECESARIO  
NECESSARY SPACE  
ESPACE NECESSAIRE  
SPAZIO NECESSARIO

	MEDIDA PISCINA POOL SIZE DIMENSIONS PISCINE MISURA PISCINA	ESPACIO NECESARIO NECESSARY SPACE ESPACE NECESSAIRE SPAZIO NECESSARIO
KPEOV8127	800x470x120 cm	1010x670x135 cm
KPEOV7327	730x375x120 cm	930x575x135 cm
KPEOV6127	610x375x120 cm	810x575x135 cm
KPEOV5027	500x300x120 cm	700x500x135 cm



Liner PVC azul  
50/100  
PVC blue liner  
50/100  
Liner bleu PVC  
50/100  
Liner blu PVC  
50/100

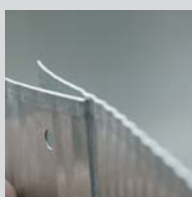

Chapa prelacada  
60/100  
Prelacquered steel  
60/100  
Tôle prélaquée  
60/100  
Lamiera laccata  
60/100



Depuradora arena  
(Caudal grupo 10/8 m³/h)  
Sand filter  
(Flow group 10/8 m³/h)  
Filtre à sable  
(Débit groupe 10/8 m³/h)  
Filtro a sabbia  
(Portata gruppo 10/8 m³/h)



	Ø460 cm	120 cm	17.440 l	295 kg	1/90x80	8m³/h	✓	258966
KPE4527	Ø460 cm	120 cm	17.440 l	295 kg	1/90x80	8m³/h	✓	258966
KPE3527	Ø350 cm	120 cm	10.102 l	280 kg	1/90x80	8m³/h	✓	262635

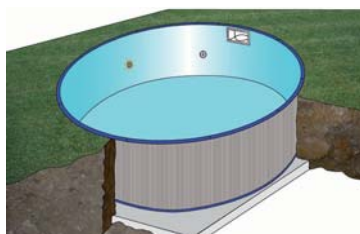

MEDIDA PISCINA  
POOL SIZE  
DIMENSIONS PISCINE  
MISURA PISCINA

ESPACIO NECESARIO  
NECESSARY SPACE  
ESPACE NECESSAIRE  
SPAZIO NECESSARIO

KPE4527	Ø460x120 cm	Ø660x135 cm
KPE3527	Ø350x120 cm	Ø550x135 cm



Escalera:  
3 peldaños - Inox.  
Ladder:  
3 steps - Stainless steel  
Echelle:  
3 marches - Acier inoxydable  
Scala:  
3 gradini - Inox



Manta protectora  
(Poliéster)  
Bottom protectiveblanket  
(Polyester)  
Tapis de sol en feutre  
(Polyester)  
Telo di protezione  
(Poliestere)



Skimmer, manguera,  
racordería...  
Skimmer, hose,  
fittings...  
Skimmer, tuyau,  
raccords...  
Skimmer, tubi, kit  
raccordi...





## PISCINA DE PARED DE ACERO CON REVESTIMIENTO DE MADERA

**LINER:** Tratamiento Anti-ultravioleta que retrasa el envejecimiento del P.V.C.

**CHAPA:** Laminada en frío con tratamiento de galvanización, fosfatación e imprimación.

Perfilación vertical de la chapa para la obtención de una mayor resistencia.

Troquelada para skimmer y válvula de retorno del agua.

**MADERA:** Madera de pino nórdico, con tratamiento NIVEL IV CLASE V, según norma Europea EN-335. Troquelada para skimmer y válvula de retorno del agua.

## PISCINE BOIS DOUBLE PAROI

**LINER:** Traitement anti-ultraviolets contre le vieillissement du P.V.C.

**TÔLE:** Tôle laminée à froid et traitée par galvanisation, phosphatage, couche d'apprêt et laquage.

Profils verticaux pour une meilleure résistance.

Découpage pour le skimmer et la vanne anti-refoulement d'eau.

**BOIS:** Pin nordique, avec traitement de niveau IV, selon la norme Européenne; EN-335

## STEEL WALL POOL WITH WOODEN COVERING

**LINER:** Anti-ultraviolet treatment to slow down P.V.C aging.

**PLATE:** Galvanized, phosphatized, primed and lacquered cold-rolled plate. Vertical sectioning for an increased strength.

Die cut for skimmer and water return valve openings.

**WOOD:** Nordic pine wood with level IV treatment according to EN-335 European Standard.

## PISCINA CON RIVESTIMENTO IN LEGNO

**LINER:** Trattamento Anti-ultravioletti - Ritarda l'invecchiamento del P.V.C.

**PANNELLO:** Laminata a freddo con trattamento di galvanizzazione, fosfatazione e preparazione.

Preparazione verticale per ottenere una maggiore resistenza.

Stampigliatura per Skimmer e valvola di ritorno dell'acqua.

**LEGNO:** Legno di pino nordico, con trattamento livello iv classe v, secondo normativa Europea EN-335. Preparazione per skimmer e valvola di ritorno dell'acqua.

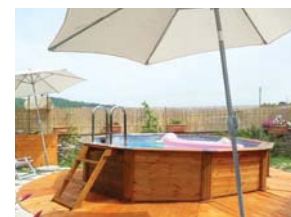

**MADE  
IN  
EU**

nature pool serie

HAWAII



Sistema de omegas Omega system  
Renforts enterrés Sistema omega

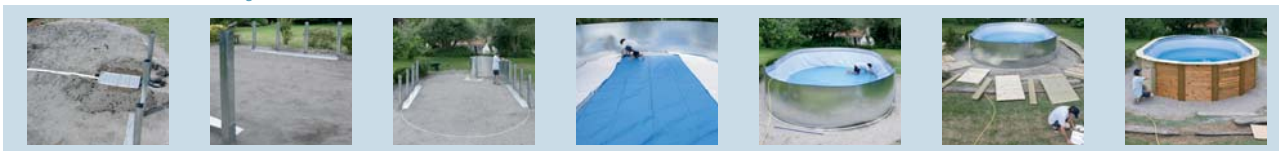

	750x425 cm	132 cm	28.050 l	497/498 kg	1/120x80 1/134x116	7m <sup>3</sup> /h	√	√	28	19,5/22	227726
KITNPOV731											
KITNPOV611	640x425 cm	132 cm	23.230 l	411/421 kg	1/120x80 1/134x116	7m <sup>3</sup> /h	√	√	28	19,5/22	227733



MEDIDA PISCINA  
POOL SIZE  
DIMENSIONS PISCINE  
MISURA PISCINA

ESPACIO NECESARIO  
NECESSARY SPACE  
ESPACE NECESSAIRE  
SPAZIO NECESSARIO

KITNPOV731	750x425 cm	800x450 cm
KITNPOV611	640x425 cm	700x450 cm



Liner PVC gresite  
50/100  
PVC gresite liner  
50/100  
Liner carrelage PVC  
50/100  
Liner PVC gresite  
50/100



Tapas metal lacado  
Perfilería de madera  
Lacquered metal covers  
Wooden frames  
Cache-margelles métalliques  
Poteaux et margelles en bois  
Copertura metallica laccata  
Bordi in legno

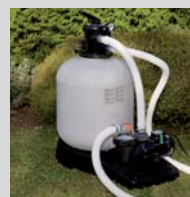

Depuradora arena  
(Caudal grupo 7/5 m<sup>3</sup>/h)  
Sand filter  
(Flow group 7/5 m<sup>3</sup>/h)  
Filtre à sable  
(Débit groupe 7/5 m<sup>3</sup>/h)  
Filtro a sabbia  
Portata gruppo 7/5 m<sup>3</sup>/h





KITNP461	Ø500 cm	132 cm	20.270 l	217/385 kg	1/90x80 1/134x116	5m <sup>3</sup> /h	√	√	28	19,5	227764



	MEDIDA PISCINA POOL SIZE DIMENSIONS PISCINE MISURA PISCINA	ESPACIO NECESARIO NECESSARY SPACE ESPACE NECESSAIRE SPAZIO NECESSARIO
KITNP461	Ø550 cm	510x510 cm



Tinte  
Woodstainer  
Lasure  
Verniciatura



Escalera:  
- Madera / acero inoxidable  
Ladder:  
- Bois / stainless steel  
Échelle:  
- Bois / acier inoxydable  
Scale:  
- Legno / acciaio inox

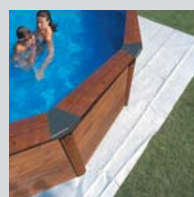

Manta protectora  
(Poliéster)  
Bottom protectiveblanket  
(Polyester)  
Tapis de sol en feutre  
(Polyester)  
Telo di protezione  
(Poliestere)



Limpiafondos  
automático  
Automatic pool  
cleaner  
Aspirateur  
automatique  
Pulisci-fondo  
automatico

# nature pool serie ISLAND



Sistema de omegas Omega system Renforts enterrés Sistema omega

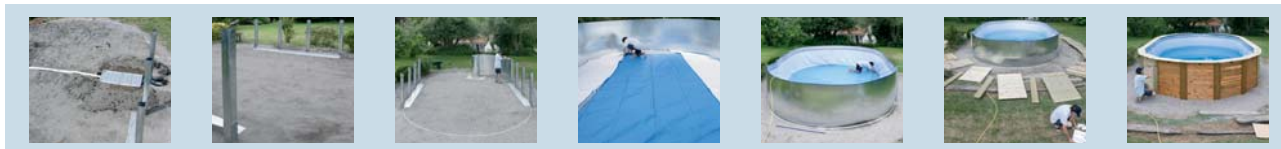

	Dimensions	Capacity	Volume	Weight	Box Size	Flow Rate	Accessories	Accessories	Accessories	Accessories	Accessories	Barcode
KITNPOV732	745x420 cm	120 cm	25.180 L	482/404 kg	1/90x80 1/124x116	5m <sup>3</sup> /h	✓	✓	24	19,5/22	224923	
KITNPOV612	635x420 cm	120 cm	20.890 l	378/366 kg	1/90x80 1/124x116	4m <sup>3</sup> /h	✓	✓	24	19,5/22	220093	
KITNPOV502	535x345 cm	120 cm	14.000 l	352/356 kg	1/90x80 1/124x116	3m <sup>3</sup> /h	✓	✓	24	14,5/22	220109	



MEDIDA PISCINA  
POOL SIZE  
DIMENSIONS PISCINE  
MISURA PISCINA

ESPACIO NECESARIO  
NECESSARY SPACE  
ESPACE NECESSAIRE  
SPAZIO NECESSARIO

KITNPOV732	745x420 cm	800x450 cm
KITNPOV612	635x420 cm	700x450 cm
KITNPOV502	535x345 cm	600x375 cm



Liner PVC azul  
40/100  
PVC blue liner  
40/100  
Liner bleu  
40/100  
Liner blu  
40/100

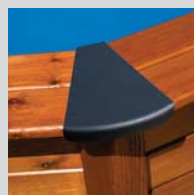

Tapas metal lacado  
Perfilería de madera  
Lacquered metal covers  
Wooden frames  
Cache-margelles métalliques  
Poteaux et margelles en bois  
Copertura metallica laccata  
Bordi in legno

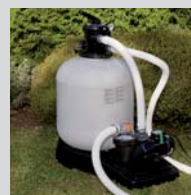

Depuradora arena  
(Caudal grupo 5/4/3 m<sup>3</sup>/h)  
Sand filter  
(Flow group 5/4/3 m<sup>3</sup>/h)  
Filtre à sable  
(Débit groupe 5/4/3 m<sup>3</sup>/h)  
Filtro a sabbia  
(Portata gruppo 5/4/3 m<sup>3</sup>/h)



	Ø	H	V	P	W	F	L	B	M	W	Barcode
KITNP462	Ø490 cm	120 cm	17.450 l	199/337 kg	1/80x60 1/124x116	3m <sup>3</sup> /h	√	√	24	19,5	220123
KITNP352A	Ø390 cm	120 cm	10.102 l	185/221 kg	1/80x60 1/124x116	3m <sup>3</sup> /h	√	√	24	14,5	224930
KITNP242A	Ø280 cm	120 cm	4.750 l	159/219 kg	1/80x60 1/124x94,5	3m <sup>3</sup> /h	√	√	24	14,5	230924



	MEDIDA PISCINA POOL SIZE DIMENSIONS PISCINE MISURA PISCINA	ESPACIO NECESARIO NECESSARY SPACE ESPACE NECESSAIRE SPAZIO NECESSARIO
KITNP462	Ø490 cm	510x510 cm
KITNP352	Ø390 cm	410x410 cm
KITNP242	Ø280 cm	300x300 cm



Escalera:  
- Madera / acero inoxidable  
Ladder:  
- Bois / stainless steel  
Échelle:  
- Bois / acier inoxydable  
Scale:  
- Legno / acciaio inox



Tapiz protector  
(Polietileno)  
Floor tapestry  
(Polythene)  
Tapis de sol en feutre  
(Polyéthylène)  
Telo di protezione  
(Polietilene)



Tinte  
Woodstainer  
Lasure  
Verniciatura



## PISCINA DE PARED DE ACERO

**LINER:** Tratamiento Anti - Ultravioleta que retrasa el envejecimiento del P.V.C.

**CHAPA:** laminada en frío con tratamiento de galvanización, fosfatación, imprimación y lacado.

Perfilación vertical de la misma para la obtención de una mayor resistencia.

Troquelada para skimmer y válvula de retorno del agua.

**PERFILES::** De acero y de P.V.C.

## PISCINE PAROI ACIER

**LINER:** Traitement anti-ultraviolets contre le vieillissement du P.V.C.

**TÔLE:** Tôle laminée à froid et traitée par galvanisation, phosphatage, couche d'apprêt et laquage.

Profils verticaux pour une meilleure résistance.

Découpage pour le skimmer et la buse de refoulement.

**STRUCTURE:** Métalliques et P.V.C.

## STEEL WALL POOL

**LINER:** Anti-ultraviolet treatment to slow down P.V.C aging.

**PLATE:** Galvanized, Galvanized, phosphatized, primed and lacquered cold-rolled plate .

Vertical sectioning for an increased strength . Die cut for skimmer and water return valve openings.

**PROFILES:** Metal or P.V.C

## PISCINA CON PARETI IN ACCIAIO

**LINER:** Trattamento Anti-ultravioletti - Ritarda l'invecchiamento del P.V.C.

**PANNELLO:** Laminata a freddo con trattamento di galvanizzazione, fosfatazione e preparazione.

Preparazione verticale per ottenere una maggiore resistenza.

Stampigliatura per Skimmer e valvola di ritorno dell'acqua.

**PROFILI:** Acciaio e P.V.C.



**MADE  
IN  
EU**

dream pool serie

# CRETA



KITPROV7388NRT



	730x375 cm	132 cm	28.217 l	462 kg	1/120x80	5m <sup>3</sup> /h	√	√	15	12	262086
KITPROV7388NRT	730x375 cm	132 cm	28.217 l	462 kg	1/120x80	5m <sup>3</sup> /h	√	√	15	12	262086
KITPROV6188NRT	610x375 cm	132 cm	23.281 l	437 kg	1/90x80	5m <sup>3</sup> /h	√	√	15	12	262093

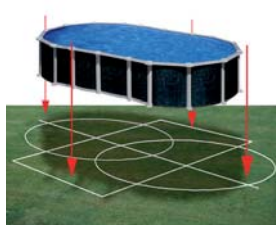

MEDIDA PISCINA  
POOL SIZE  
DIMENSIONS PISCINE  
MISURA PISCINA

ESPACIO NECESARIO  
NECESSARY SPACE  
ESPACE NECESSAIRE  
SPAZIO NECESSARIO

KITPROV7388NRT	730x375 cm	770x495 cm
KITPROV6188NRT	610x375 cm	650x495 cm



Liner PVC azul  
40/100  
PVC blue liner  
40/100  
Liner PVC bleu  
40/100  
Liner PVC blu  
40/100



Protectores de  
inyección  
Injection saver  
Protections moulées  
par injection  
Angolare di  
protezione



Perfilería de acero  
Steel profiles  
Poteaux et margelles  
acier  
Profili in acciaio

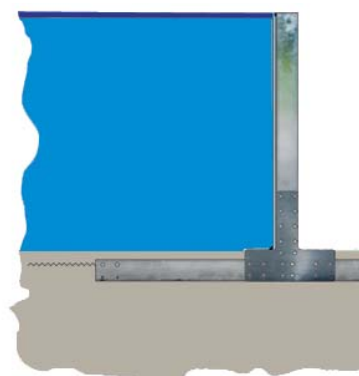

Viga de acero enterrada de 15x15cm que hace innecesarios los postes exteriores, obteniendo mejor aprovechamiento del jardín.

15x15cm buried steel beam makes unnecessary the outer posts, optimizing the use of the garden area.

Poteaux en acier à enterrer de 15x15 évitant des renforts apparents extérieurs, pour mieux profiter de l'espace du jardin.

Barra di acciaio interrata da 15x15 cm che non rende necessario l'utilizzo delle barre laterali; permette di poter sfruttare al meglio gli spazi del proprio giardino.



Sistema de omegas Omega system Renforts enterrés Sistema omega



Depuradora arena  
(Caudal grupo 5 m<sup>3</sup>/h)  
Sand filter  
(Flow group 5 m<sup>3</sup>/h)  
Filtre à sable  
(Débit groupe 5 m<sup>3</sup>/h)  
Filtro a sabbia  
Portata gruppo 5 m<sup>3</sup>/h



Escalera de seguridad  
Plataforma +2x3 Peldaños  
Safety Ladder  
Platform + 2x3 Steps  
Échelle sécurité  
Plateforme + 2x3 Marches  
Scala di sicurezza  
Piattaforma + 2x3 Gradini

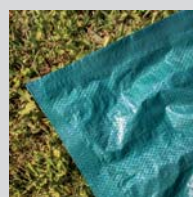

Tapiz protector  
(Polietileno)  
Floor tapestry  
(Polythene)  
Tapis de sol en feutre  
(Polyéthylène)  
Telo di protezione  
(Polietilene)

# dream pool serie RATTAN



KITPROV738NRT



	730x375 cm	132 cm	28.217 l	335 kg	1/120x80	5m <sup>3</sup> /h	√	√	15	12	257259
KITPROV738NRT	730x375 cm	132 cm	28.217 l	335 kg	1/120x80	5m <sup>3</sup> /h	√	√	15	12	257259
KITPROV618NRT	610x375 cm	132 cm	23.281 l	270 kg	1/90x80	5m <sup>3</sup> /h	√	√	15	12	257266
KITPROV508NRT	500x300 cm	132 cm	16.210 l	260 kg	1/90x80	5m <sup>3</sup> /h	√	√	15	12	258072

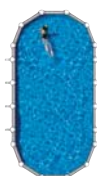

MEDIDA PISCINA  
POOL SIZE  
DIMENSIONS PISCINE  
MISURA PISCINA

ESPACIO NECESARIO  
NECESSARY SPACE  
ESPACE NECESSAIRE  
SPAZIO NECESSARIO

KITPROV738NRT	730x375 cm	770x595 cm
KITPROV618NRT	610x375 cm	650x595 cm
KITPROV508NRT	500x300 cm	540x520 cm



Liner PVC azul  
40/100  
PVC blue liner  
40/100  
Liner PVC bleu  
40/100  
Liner PVC blu  
40/100



Protectores de  
inyección  
Injection saver  
Protections moulées  
par injection  
Angolare di  
protezione



Perfilería de acero  
Steel profiles  
Poteaux et margelles  
acier  
Profili in acciaio





KITPR558NRT



	Ø	h	V	P	B	Q	L	F	S	ST	BT
KITPR558NRT	Ø550 cm	132 cm	27.798 l	243 kg	1/90x80	5m³/h	√	√	15	12	257273
KITPR458NRT	Ø460 cm	132 cm	19.444 l	238 kg	1/90x80	5m³/h	√	√	15	12	257280
KITPR358NRT	Ø350 cm	132 cm	11.250 l	184 kg	1/90x80	5m³/h	√	√	15	12	257297

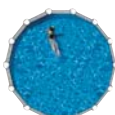

	MEDIDA PISCINA POOL SIZE DIMENSIONS PISCINE MISURA PISCINA	ESPACIO NECESARIO NECESSARY SPACE ESPACE NECESSAIRE SPAZIO NECESSARIO
KITPR558NRT	Ø 550cm	600x600 cm
KITPR458NRT	Ø 460cm	500x500 cm
KITPR358NRT	Ø 350cm	400x400 cm



Depuradora arena  
(Caudal grupo 5 m³/h)  
Sand filter  
(Flow group 5 m³/h)  
Filtre à sable  
(Débit groupe 5 m³/h)  
Filtro a sabbia  
Portata gruppo 5 m³/h



Escala de seguridad  
Plataforma +2x3 Peldaños  
Safety Ladder  
Platform + 2x3 Steps  
Échelle sécurité  
Plateforme + 2x3 Marches  
Scala di sicurezza  
Piattaforma + 2x3 Gradini

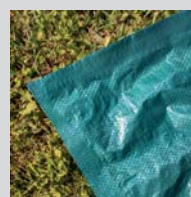

Tapiz protector  
(Polietileno)  
Floor tapestry  
(Polythene)  
Tapis de sol en feutre  
(Polyéthylène)  
Telo di protezione  
(Polietilene)

dream pool serie

# BARBADOS



KIT610NRT



	730x375 cm	610x375 cm	500x300 cm	120 cm	25.323 l	20.893 l	14.550 l	287 kg	235 kg	224 kg	1/90x80	1/80x60	1/80x60	4m <sup>3</sup> /h	3m <sup>3</sup> /h	3m <sup>3</sup> /h	√	√	√	15	12	12	257662	257655	257648	
KIT730NRT																										
KIT610NRT																										
KIT500NRT																										

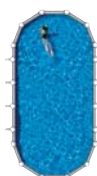

MEDIDA PISCINA  
POOL SIZE  
DIMENSIONS PISCINE  
MISURA PISCINA

ESPACIO NECESARIO  
NECESSARY SPACE  
ESPACE NECESSAIRE  
SPAZIO NECESSARIO

KIT730NRT	730x375 cm	770x595 cm
KIT610NRT	610x375 cm	650x595 cm
KIT500NRT	500x300 cm	540x520 cm



Liner PVC azul 30/100  
KIT730NRT/KIT610NRT: 40/100  
PVC blue liner 30/100  
KIT730NRT/KIT610NRT: 40/100  
Liner PVC bleu 30/100  
KIT730NRT/KIT610NRT: 40/100  
Liner PVC blu 30/100  
KIT730NRT/KIT610NRT: 40/100



Protectores de inyección  
Injection saver  
Protections moulées par injection  
Angolare di protezione



Perfilería de acero  
Steel profiles  
Poteaux et margelles acier  
Profili in acciaio



KIT350NRT



	Ø460 cm	120 cm	17.450 l	172 kg	1/80x60	3m³/h	√	15	12	257679
KIT460NRT	Ø460 cm	120 cm	17.450 l	172 kg	1/80x60	3m³/h	√	15	12	257679
KIT350NRT	Ø350 cm	120 cm	10.102 l	146 kg	1/80x60	3m³/h	√	15	12	257686



MEDIDA PISCINA  
POOL SIZE  
DIMENSIONS PISCINE  
MISURA PISCINA

ESPACIO NECESARIO  
NECESSARY SPACE  
ESPACE NECESSAIRE  
SPAZIO NECESSARIO

KIT460NRT	Ø 460cm	500x500 cm
KIT350NRT	Ø 350cm	400x400 cm

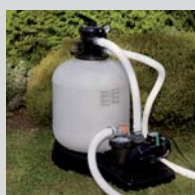

Depuradora arena  
(Caudal grupo 3/4 m³/h)  
Sand filter  
(Flow group 3/4 m³/h)  
Filtre à sable  
(Débit groupe 3/4 m³/h)  
Filtro a sabbia  
Portata gruppo 3/4 m³/h

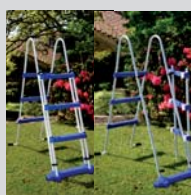

Escalera de seguridad  
2x3 Peldaños  
Safety Ladder  
2x3 Steps  
Echelle sécurité  
2x3 Marches  
Scala di sicurezza  
2x3 Gradini

# dream pool serie CELOSIA



KITPROV738C



	730x375 cm	132 cm	28.217 l	335 kg	1/120x80	5m <sup>3</sup> /h	√	√	15	12	241661
KITPROV738C	730x375 cm	132 cm	28.217 l	335 kg	1/120x80	5m <sup>3</sup> /h	√	√	15	12	241661
KITPROV618C	610x375 cm	132 cm	23.281 l	270 kg	1/90x80	5m <sup>3</sup> /h	√	√	15	12	241678
KITPROV508C	500x300 cm	132 cm	16.210 l	260 kg	1/90x80	5m <sup>3</sup> /h	√	√	15	12	258102

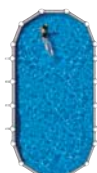

MEDIDA PISCINA  
POOL SIZE  
DIMENSIONS PISCINE  
MISURA PISCINA

ESPACIO NECESARIO  
NECESSARY SPACE  
ESPACE NECESSAIRE  
SPAZIO NECESSARIO

KITPROV738C	730x375 cm	770x595 cm
KITPROV618C	610x375 cm	650x595 cm
KITPROV508C	500x300 cm	540x520 cm



Liner PVC azul  
40/100  
PVC blue liner  
40/100  
Liner PVC bleu  
40/100  
Liner PVC blu  
40/100



Protectores de  
inyección  
Injection saver  
Protections moulées  
par injection  
Angolare di  
protezione

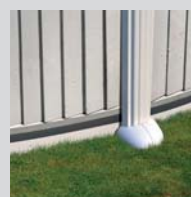

Perfilería de acero  
Steel profiles  
Poteaux et margelles  
acier  
Profili in acciaio



KITPR558C



8412081

	Ø550 cm	132 cm	27.798 l	243 kg	1/90x80	5m <sup>3</sup> /h	√	√	15	12	241685
KITPR558C	Ø550 cm	132 cm	27.798 l	243 kg	1/90x80	5m <sup>3</sup> /h	√	√	15	12	241685
KITPR458C	Ø460 cm	132 cm	19.444 l	238 kg	1/90x80	5m <sup>3</sup> /h	√	√	15	12	241692
KITPR358C	Ø350 cm	132 cm	11.250 l	184 kg	1/90x80	5m <sup>3</sup> /h	√	√	15	12	258157

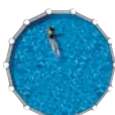

MEDIDA PISCINA  
POOL SIZE  
DIMENSIONS PISCINE  
MISURA PISCINA

ESPACIO NECESARIO  
NECESSARY SPACE  
ESPACE NECESSAIRE  
SPAZIO NECESSARIO

	MEDIDA PISCINA POOL SIZE DIMENSIONS PISCINE MISURA PISCINA	ESPACIO NECESARIO NECESSARY SPACE ESPACE NECESSAIRE SPAZIO NECESSARIO
KITPR558C	Ø 550cm	600x600 cm
KITPR458C	Ø 460cm	500x500 cm
KITPR358C	Ø 350cm	400x400 cm



Depuradora arena  
(Caudal grupo 5 m<sup>3</sup>/h)  
Sand filter  
(Flow group 5 m<sup>3</sup>/h)  
Filtre à sable  
(Débit groupe 5 m<sup>3</sup>/h)  
Filtro a sabbia  
Portata gruppo 5 m<sup>3</sup>/h



Escalera de seguridad  
Plataforma +2x3 Peldaños  
Safety Ladder  
Platform + 2x3 Steps  
Échelle sécurité  
Plateforme + 2x3 Marches  
Scala di sicurezza  
Piattaforma + 2x3 Gradini

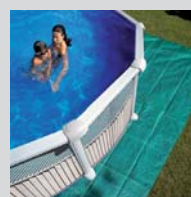

Tapiz protector  
(Polietileno)  
Floor tapestry  
(Polythene)  
Tapis de sol en feutre  
(Polyéthylène)  
Telo di protezione  
(Polietilene)

# dream pool serie **CAPRI**



KIT610C



8412081

	730x375 cm	120 cm	25.323 l	287 kg	1/90x80	4m <sup>3</sup> /h	√	15	12	250625
KIT730C	730x375 cm	120 cm	25.323 l	287 kg	1/90x80	4m <sup>3</sup> /h	√	15	12	250625
KIT610C	610x375 cm	120 cm	20.893 l	235 kg	1/80x60	3m <sup>3</sup> /h	√	15	12	250632
KIT500C	500x300 cm	120 cm	14.550 l	224 kg	1/80x60	3m <sup>3</sup> /h	√	15	12	255989

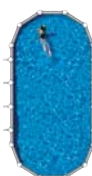

MEDIDA PISCINA  
POOL SIZE  
DIMENSIONS PISCINE  
MISURA PISCINA

ESPACIO NECESARIO  
NECESSARY SPACE  
ESPACE NECESSAIRE  
SPAZIO NECESSARIO

	730x375 cm	770x595 cm
KIT730C	730x375 cm	770x595 cm
KIT610C	610x375 cm	650x595 cm
KIT500C	500x300 cm	540x520 cm



Liner PVC azul 30/100  
KIT730C/KIT610C: 40/100  
PVC blue liner 30/100  
KIT730C/KIT610C: 40/100  
Liner PVC bleu 30/100  
KIT730C/KIT610C: 40/100  
Liner PVC blu 30/100  
KIT730C/KIT610C: 40/100



Protectores de inyección  
Injection saver  
Protections moulées par injection  
Angolare di protezione



Perfilería de acero  
Steel profiles  
Poteaux et margelles acier  
Profili in acciaio



KIT350C



KIT460C	Ø460 cm	120 cm	17.450 l	172 kg	1/80x60	3m <sup>3</sup> /h	√	15	12	250649
KIT350C	Ø350 cm	120 cm	10.102 l	146 kg	1/80x60	3m <sup>3</sup> /h	√	15	12	250656



MEDIDA PISCINA  
POOL SIZE  
DIMENSIONS PISCINE  
MISURA PISCINA

ESPACIO NECESARIO  
NECESSARY SPACE  
ESPACE NECESSAIRE  
SPAZIO NECESSARIO

KIT460C	Ø 460cm	500x500 cm
KIT350C	Ø 350cm	400x400 cm



Depuradora arena  
(Caudal grupo 3/4 m<sup>3</sup>/h)  
Sand filter  
(Flow group 3/4 m<sup>3</sup>/h)  
Filtre à sable  
(Débit groupe 3/4 m<sup>3</sup>/h)  
Filtro a sabbia  
Portata gruppo 3/4 m<sup>3</sup>/h

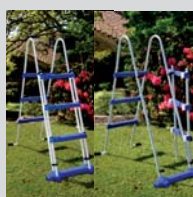

Escalera de seguridad  
2x3 Peldaños  
Safety Ladder  
2x3 Steps  
Échelle sécurité  
2x3 Marches  
Scala di sicurezza  
2x3 Gradini

# dream pool serie MYKONOS



KITPROV7388P



	730x375 cm	132 cm	28.217 l	462 kg	1/120x80	5m <sup>3</sup> /h	√	√	15	12	230849
KITPROV7388P	730x375 cm	132 cm	28.217 l	462 kg	1/120x80	5m <sup>3</sup> /h	√	√	15	12	230849
KITPROV6188P	610x375 cm	132 cm	23.281 l	437 kg	1/90x80	5m <sup>3</sup> /h	√	√	15	12	230856

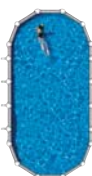

MEDIDA PISCINA  
POOL SIZE  
DIMENSIONS PISCINE  
MISURA PISCINA

ESPACIO NECESARIO  
NECESSARY SPACE  
ESPACE NECESSAIRE  
SPAZIO NECESSARIO

KITPROV7388P	730x375 cm	770x495 cm
KITPROV6188P	610x375 cm	650x495 cm



Liner PVC azul  
40/100  
PVC blue liner  
40/100  
Liner PVC bleu  
40/100  
Liner PVC blu  
40/100



Protectores de  
inyección  
Injection saver  
Protections moulées  
par injection  
Angolare di  
protezione



Perfilería de acero  
Steel profiles  
Poteaux et margelles  
acier  
Profili in acciaio



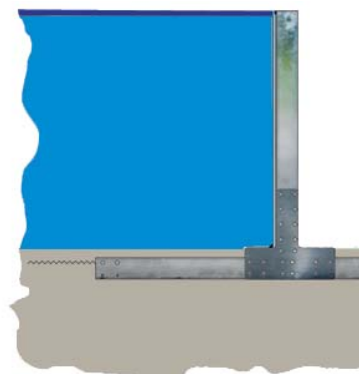

Viga de acero enterrada de 15x15cm que hace innecesarios los postes exteriores, obteniendo mejor aprovechamiento del jardín.

15x15cm buried steel beam makes unnecessary the outer posts, optimizing the use of the garden area.

Poteaux en acier à enterrer de 15x15 évitant des renforts apparents extérieurs, pour mieux profiter de l'espace du jardin.

Barra di acciaio interrata da 15x15 cm che non rende necessario l'utilizzo delle barre laterali; permette di poter sfruttare al meglio gli spazi del proprio giardino.



Sistema de omegas Omega system Renforts enterrés Sistema omega



Depuradora arena  
(Caudal grupo 5 m<sup>3</sup>/h)  
Sand filter  
(Flow group 5 m<sup>3</sup>/h)  
Filtre à sable  
(Débit groupe 5 m<sup>3</sup>/h)  
Filtro a sabbia  
Portata gruppo 5 m<sup>3</sup>/h



Escalera de seguridad  
Plataforma +2x3 Peldaños  
Safety Ladder  
Platform + 2x3 Steps  
Échelle sécurité  
Plateforme + 2x3 Marches  
Scala di sicurezza  
Piattaforma + 2x3 Gradini

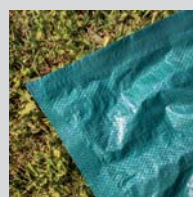

Tapiz protector  
(Polietileno)  
Floor tapestry  
(Polythene)  
Tapis de sol en feutre  
(Polyéthylène)  
Telo di protezione  
(Polietilene)

# dream pool serie SKYATHOS



KITPROV738P



	730x375 cm	132 cm	28.217 l	335 kg	1/120x80	5m <sup>3</sup> /h	√	√	15	12	230870
KITPROV738P	730x375 cm	132 cm	28.217 l	335 kg	1/120x80	5m <sup>3</sup> /h	√	√	15	12	230870
KITPROV618P	610x375 cm	132 cm	23.281 l	270 kg	1/90x80	5m <sup>3</sup> /h	√	√	15	12	230887
KITPROV508P	500x300 cm	132 cm	16.210 l	260 kg	1/90x80	5m <sup>3</sup> /h	√	√	15	12	258096

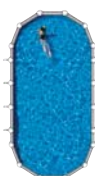

MEDIDA PISCINA  
POOL SIZE  
DIMENSIONS PISCINE  
MISURA PISCINA

ESPACIO NECESARIO  
NECESSARY SPACE  
ESPACE NECESSAIRE  
SPAZIO NECESSARIO

KITPROV738P	730x375 cm	770x595 cm
KITPROV618P	610x375 cm	650x595 cm
KITPROV508P	500x300 cm	540x520 cm



Liner PVC azul  
40/100  
PVC blue liner  
40/100  
Liner PVC bleu  
40/100  
Liner PVC blu  
40/100



Protectores de  
inyección  
Injection saver  
Protections moulées  
par injection  
Angolare di  
protezione



Perfilería de acero  
Steel profiles  
Poteaux et margelles  
acier  
Profili in acciaio



KITPR558P



	Ø	Height	Capacity (l)	Weight (kg)	Storage (cm)	Flow (m³/h)	✓	✓	Pool Tapestry	Pool Cover	Barcode
KITPR558P	Ø550 cm	132 cm	27.798 l	243 kg	1/90x80	5m³/h	✓	✓	15	12	230894
KITPR458P	Ø460 cm	132 cm	19.444 l	238 kg	1/90x80	5m³/h	✓	✓	15	12	230900
KITPR358P	Ø350 cm	132 cm	11.250 l	184 kg	1/90x80	5m³/h	✓	✓	15	12	233888

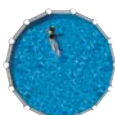

	MEDIDA PISCINA POOL SIZE DIMENSIONS PISCINE MISURA PISCINA	ESPACIO NECESARIO NECESSARY SPACE ESPACE NECESSAIRE SPAZIO NECESSARIO
KITPR558P	Ø 550cm	600x600 cm
KITPR458P	Ø 460cm	500x500 cm
KITPR358P	Ø 350cm	400x400 cm



Depuradora arena  
(Caudal grupo 5 m³/h)  
Sand filter  
(Flow group 5 m³/h)  
Filtre à sable  
(Débit groupe 5 m³/h)  
Filtro a sabbia  
Portata gruppo 5 m³/h



Escalera de seguridad  
Plataforma +2x3 Peldaños  
Safety Ladder  
Platform + 2x3 Steps  
Échelle sécurité  
Plateforme + 2x3 Marches  
Scala di sicurezza  
Piattaforma + 2x3 Gradini

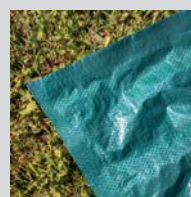

Tapiz protector  
(Polietileno)  
Floor tapestry  
(Polythene)  
Tapis de sol en feutre  
(Polyéthylène)  
Telo di protezione  
(Polietilene)

# dream pool serie IRAKLION



KIT730P



	730x375 cm	120 cm	25.323 l	287 kg	1/90x80	4m <sup>3</sup> /h	√	15	12	237558
KIT730P	730x375 cm	120 cm	25.323 l	287 kg	1/90x80	4m <sup>3</sup> /h	√	15	12	237558
KIT610P	610x375 cm	120 cm	20.893 l	235 kg	1/80x60	3m <sup>3</sup> /h	√	15	12	233581
KIT500P	500x300 cm	120 cm	14.550 l	224 kg	1/80x60	3m <sup>3</sup> /h	√	15	12	233598

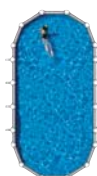

MEDIDA PISCINA  
POOL SIZE  
DIMENSIONS PISCINE  
MISURA PISCINA

ESPACIO NECESARIO  
NECESSARY SPACE  
ESPACE NECESSAIRE  
SPAZIO NECESSARIO

KIT730P	730x375 cm	770x595 cm
KIT610P	610x375 cm	650x595 cm
KIT500P	500x300 cm	540x520 cm



Liner PVC azul 30/100  
KIT730P/KIT610P: 40/100  
PVC blue liner 30/100  
KIT730P/KIT610P: 40/100  
Liner PVC bleu 30/100  
KIT730P/KIT610P: 40/100  
Liner PVC blu 30/100  
KIT730P/KIT610P: 40/100



Protectores de inyección  
Injection saver  
Protections moulées par injection  
Angolare di protezione



Perfilería de acero  
Steel profiles  
Poteaux et margelles acier  
Profili in acciaio



KIT460P



8412081

	Ø	Height	Capacity	Weight	Box Size	Flow	✓	Steps	Covers	Barcode
KIT460P	Ø460 cm	120 cm	17.450 l	172 kg	1/80x60	3m <sup>3</sup> /h	✓	15	12	233376
KIT350P	Ø350 cm	120 cm	10.102 l	146 kg	1/80x60	3m <sup>3</sup> /h	✓	15	12	233611
KIT240P	Ø240 cm	120 cm	4.750 l	126 kg	1/80x60	3m <sup>3</sup> /h	✓	15	12	237718



	MEDIDA PISCINA POOL SIZE DIMENSIONS PISCINE MISURA PISCINA	ESPACIO NECESARIO NECESSARY SPACE ESPACE NECESSAIRE SPAZIO NECESSARIO
KIT460P	Ø 460cm	500x500 cm
KIT350P	Ø 350cm	400x400 cm
KIT240P	Ø 240cm	300x300 cm



Depuradora arena  
(Caudal grupo 3/4 m<sup>3</sup>/h)  
Sand filter  
(Flow group 3/4 m<sup>3</sup>/h)  
Filtre à sable  
(Débit groupe 3/4 m<sup>3</sup>/h)  
Filtro a sabbia  
Portata gruppo 3/4 m<sup>3</sup>/h

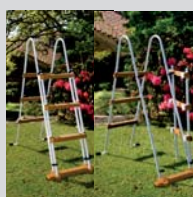

Escalera de seguridad  
2x3 Peldaños  
Safety Ladder  
2x3 Steps  
Échelle sécurité  
2x3 Marches  
Scala di sicurezza  
2x3 Gradini

dream pool serie

# AMAZONIA



KITPROV7388WO



	730x375 cm	132 cm	28.217 l	462 kg	1/120x80	5m <sup>3</sup> /h	√	√	15	12	227436
KITPROV7388WO	730x375 cm	132 cm	28.217 l	462 kg	1/120x80	5m <sup>3</sup> /h	√	√	15	12	227436
KITPROV6188WO	610x375 cm	132 cm	23.281 l	437 kg	1/90x80	5m <sup>3</sup> /h	√	√	15	12	227443



MEDIDA PISCINA  
POOL SIZE  
DIMENSIONS PISCINE  
MISURA PISCINA

ESPACIO NECESARIO  
NECESSARY SPACE  
ESPACE NECESSAIRE  
SPAZIO NECESSARIO

KITPROV7388WO	730x375 cm	770x495 cm
KITPROV6188WO	610x375 cm	650x495 cm



Liner PVC azul  
40/100  
PVC blue liner  
40/100  
Liner PVC bleu  
40/100  
Liner PVC blu  
40/100

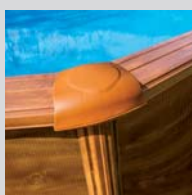

Protectores de  
inyección  
Injection saver  
Protections moulées  
par injection  
Angolare di  
protezione

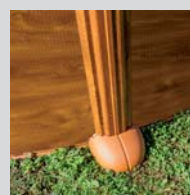

Perfilería de acero  
Steel profiles  
Poteaux et margelles  
acier  
Profili in acciaio

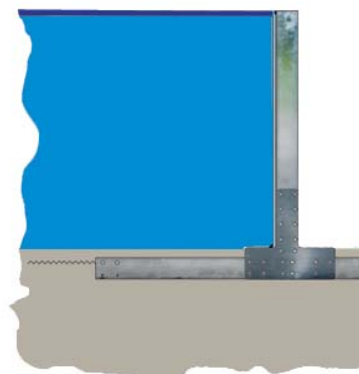

Viga de acero enterrada de 15x15cm que hace innecesarios los postes exteriores, obteniendo mejor aprovechamiento del jardín.

15x15cm buried steel beam makes unnecessary the outer posts, optimizing the use of the garden area.

Poteaux en acier à enterrer de 15x15 évitant des renforts apparents extérieurs, pour mieux profiter de l'espace du jardin.

Barra di acciaio interrata da 15x15 cm che non rende necessario l'utilizzo delle barre laterali; permette di poter sfruttare al meglio gli spazi del proprio giardino.



Sistema de omegas Omega system Renforts enterrés Sistema omega

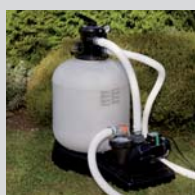

Depuradora arena  
(Caudal grupo 5 m<sup>3</sup>/h)  
Sand filter  
(Flow group 5 m<sup>3</sup>/h)  
Filtre à sable  
(Débit groupe 5 m<sup>3</sup>/h)  
Filtro a sabbia  
Portata gruppo 5 m<sup>3</sup>/h



Escalera de seguridad  
Plataforma +2x3 Peldaños  
Safety Ladder  
Platform + 2x3 Steps  
Échelle sécurité  
Plateforme + 2x3 Marches  
Scala di sicurezza  
Piattaforma + 2x3 Gradini

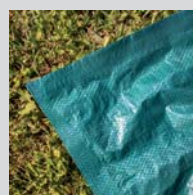

Tapiz protector  
(Polietileno)  
Floor tapestry  
(Polythene)  
Tapis de sol en feutre  
(Polyéthylène)  
Telo di protezione  
(Polietilene)

dream pool serie

# MAURITIUS



KITPROV738WO



	730x375 cm	132 cm	28.217 l	335 kg	1/120x80	5m <sup>3</sup> /h	√	√	15	12	257358
KITPROV738WO	730x375 cm	132 cm	28.217 l	335 kg	1/120x80	5m <sup>3</sup> /h	√	√	15	12	257358
KITPROV618WO	610x375 cm	132 cm	23.281 l	270 kg	1/90x80	5m <sup>3</sup> /h	√	√	15	12	257365
KITPROV508WO	500x300 cm	132 cm	16.210 l	260 kg	1/90x80	5m <sup>3</sup> /h	√	√	15	12	258089

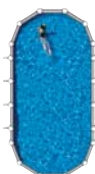

MEDIDA PISCINA  
POOL SIZE  
DIMENSIONS PISCINE  
MISURA PISCINA

ESPACIO NECESARIO  
NECESSARY SPACE  
ESPACE NECESSAIRE  
SPAZIO NECESSARIO

KITPROV738WO	730x375 cm	770x595 cm
KITPROV618WO	610x375 cm	650x595 cm
KITPROV508WO	500x300 cm	540x520 cm



Liner PVC azul  
40/100  
PVC blue liner  
40/100  
Liner PVC bleu  
40/100  
Liner PVC blu  
40/100

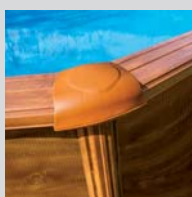

Protectores de  
inyección  
Injection saver  
Protections moulées  
par injection  
Angolare di  
protezione

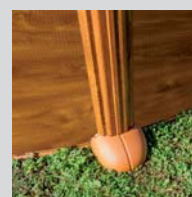

Perfilería de acero  
Steel profiles  
Poteaux et margelles  
acier  
Profili in acciaio





KITPR558WO



8412081

	Ø	h	V	P	Box	Flow	✓	✓	Steps	Platform	Barcode
KITPR558WO	Ø550 cm	132 cm	27.798 l	243 kg	1/90x80	5m³/h	✓	✓	15	12	257372
KITPR458WO	Ø460 cm	132 cm	19.444 l	238 kg	1/90x80	5m³/h	✓	✓	15	12	257389
KITPR358WO	Ø350 cm	132 cm	11.250 l	184 kg	1/90x80	5m³/h	✓	✓	15	12	257396



	MEDIDA PISCINA POOL SIZE DIMENSIONS PISCINE MISURA PISCINA	ESPACIO NECESARIO NECESSARY SPACE ESPACE NECESSAIRE SPAZIO NECESSARIO
KITPR558WO	Ø 550cm	600x600 cm
KITPR458WO	Ø 460cm	500x500 cm
KITPR358WO	Ø 350cm	400x400 cm



Depuradora arena  
(Caudal grupo 5 m³/h)  
Sand filter  
(Flow group 5 m³/h)  
Filtre à sable  
(Débit groupe 5 m³/h)  
Filtro a sabbia  
Portata gruppo 5 m³/h



Escalera de seguridad  
Plataforma +2x3 Peldaños  
Safety Ladder  
Platform + 2x3 Steps  
Échelle sécurité  
Plateforme + 2x3 Marches  
Scala di sicurezza  
Piattaforma + 2x3 Gradini

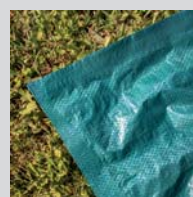

Tapiz protector  
(Polietileno)  
Floor tapestry  
(Polythene)  
Tapis de sol en feutre  
(Polyéthylène)  
Telo di protezione  
(Polietilene)

# dream pool serie MALDIVAS



KITPROV5083W



KITPROV5083W	500x300 cm	132 cm	16.210 l	217 kg	1/90x80	3,8m <sup>3</sup> /h	√	15	12	258041
--------------	------------	--------	----------	--------	---------	----------------------	---	----	----	--------

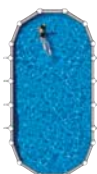

MEDIDA PISCINA  
POOL SIZE  
DIMENSIONS PISCINE  
MISURA PISCINA

ESPACIO NECESARIO  
NECESSARY SPACE  
ESPACE NECESSAIRE  
SPAZIO NECESSARIO

KITPROV5083W	500x300 cm	540x520 cm
--------------	------------	------------



Liner PVC azul  
40/100  
PVC blue liner  
40/100  
Liner PVC bleu  
40/100  
Liner PVC blu  
40/100

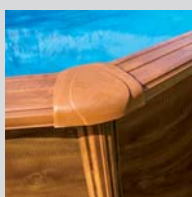

Protectores de  
inyección  
Injection saver  
Protections moulées  
par injection  
Angolare di  
protezione

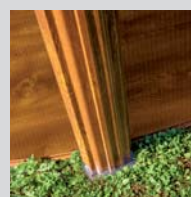

Perfilería de acero  
Steel profiles  
Poteaux et margelles  
acier  
Profili in acciaio



KITPR4583W



8412081

KITPR4583W	Ø460 cm	132 cm	19.444 l	167 kg	1/80x40	3,8m <sup>3</sup> /h	√	15	12	258058
KITPR3583W	Ø350 cm	132 cm	11.250 l	156 kg	1/80x40	3,8m <sup>3</sup> /h	√	15	12	258065

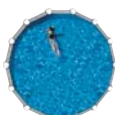

MEDIDA PISCINA  
POOL SIZE  
DIMENSIONS PISCINE  
MISURA PISCINA

ESPACIO NECESARIO  
NECESSARY SPACE  
ESPACE NECESSAIRE  
SPAZIO NECESSARIO

KITPR4583W	Ø 460cm	500x500 cm
KITPR3583W	Ø 350cm	400x400 cm



Filtro de cartucho  
(3,8 m<sup>3</sup>/h)  
Cartridge filter  
(3,8 m<sup>3</sup>/h)  
Filtre à cartouche  
(3,8 m<sup>3</sup>/h)  
Filtro a cartuccia  
(3,8 m<sup>3</sup>/h)



Escalera de seguridad  
Plataforma +2x3 Peldaños  
Safety Ladder  
Platform + 2x3 Steps  
Échelle sécurité  
Plateforme + 2x3 Marches  
Scala di sicurezza  
Piattaforma + 2x3 Gradini

# dream pool serie PACIFIC



KIT730W



	730x375 cm	120 cm	25.323 l	287 kg	1/90x80	4m <sup>3</sup> /h	√	15	12	232249
KIT730W	730x375 cm	120 cm	25.323 l	287 kg	1/90x80	4m <sup>3</sup> /h	√	15	12	232249
KIT610W	610x375 cm	120 cm	20.893 l	235 kg	1/80x60	3m <sup>3</sup> /h	√	15	12	225104
KIT500W	500x300 cm	120 cm	14.550 l	224 kg	1/80x60	3m <sup>3</sup> /h	√	15	12	231068

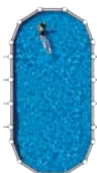

MEDIDA PISCINA  
POOL SIZE  
DIMENSIONS PISCINE  
MISURA PISCINA

ESPACIO NECESARIO  
NECESSARY SPACE  
ESPACE NECESSAIRE  
SPAZIO NECESSARIO

KIT730W	730x375 cm	770x595 cm
KIT610W	610x375 cm	650x595 cm
KIT500W	500x300 cm	540x520 cm



Liner PVC azul 30/100  
KIT730W/KIT610W: 40/100  
PVC blue liner 30/100  
KIT730W/KIT610W: 40/100  
Liner PVC bleu 30/100  
KIT730W/KIT610W: 40/100  
Liner PVC blu 30/100  
KIT730W/KIT610W: 40/100



Protectores de inyección  
Injection saver  
Protections moulées par injection  
Angolare di protezione

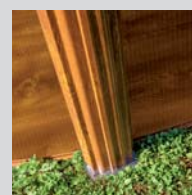

Perfilería de acero  
Steel profiles  
Poteaux et margelles acier  
Profili in acciaio



KIT460W



8412081

	Ø	Depth	Capacity	Weight	Box	Flow	✓	Steps	Stairs	Barcode
KIT460W	Ø460 cm	120 cm	17.450 l	172 kg	1/80x60	3m <sup>3</sup> /h	✓	15	12	225111
KIT350W	Ø350 cm	120 cm	10.102 l	146 kg	1/80x60	3m <sup>3</sup> /h	✓	15	12	225722
KIT240W	Ø240 cm	120 cm	4.750 l	126 kg	1/80x60	3m <sup>3</sup> /h	✓	15	12	226163

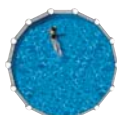

	MEDIDA PISCINA POOL SIZE DIMENSIONS PISCINE MISURA PISCINA	ESPACIO NECESARIO NECESSARY SPACE ESPACE NECESSAIRE SPAZIO NECESSARIO
KIT460W	Ø 460cm	500x500 cm
KIT350W	Ø 350cm	400x400 cm
KIT240W	Ø 240cm	300x300 cm



Depuradora arena  
(Caudal grupo 3/4 m<sup>3</sup>/h)  
Sand filter  
(Flow group 3/4 m<sup>3</sup>/h)  
Filtre à sable  
(Débit groupe 3/4 m<sup>3</sup>/h)  
Filtro a sabbia  
Portata gruppo 3/4 m<sup>3</sup>/h

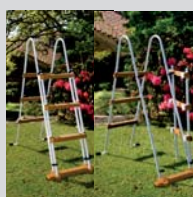

Escalera de seguridad  
2x3 Peldaños  
Safety Ladder  
2x3 Steps  
Echelle sécurité  
2x3 Marches  
Scala di sicurezza  
2x3 Gradini

dream pool serie

SICILIA



KITPROV503W



KITPROV503W

500x300 cm

120 cm

14.550 l

205 kg

1/80x60

3,8m<sup>3</sup>/h

√

15

12

258164

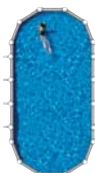

MEDIDA PISCINA  
POOL SIZE  
DIMENSIONS PISCINE  
MISURA PISCINA

ESPACIO NECESARIO  
NECESSARY SPACE  
ESPACE NECESSAIRE  
SPAZIO NECESSARIO

KITPROV503W

500x300 cm

540x520 cm



Liner PVC azul  
30/100  
PVC blue liner  
30/100  
Liner PVC bleu  
30/100  
Liner PVC blu  
30/100



Protectores de  
inyección  
Injection saver  
Protections moulées  
par injection  
Angolare di  
protezione

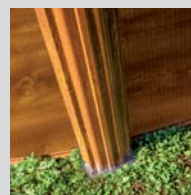

Perfilería de acero  
Steel profiles  
Poteaux et margelles  
acier  
Profili in acciaio



KITPR453W



8412081

KITPR453W	Ø460 cm	120 cm	17.450 l	149 kg	3/120x80	3,8m³/h	√	15	12	258171
KITPR353W	Ø350 cm	120 cm	10.102 l	109 kg	3/120x80	3,8m³/h	√	15	12	258188



MEDIDA PISCINA  
POOL SIZE  
DIMENSIONS PISCINE  
MISURA PISCINA

ESPACIO NECESARIO  
NECESSARY SPACE  
ESPACE NECESSAIRE  
SPAZIO NECESSARIO

KITPR453W	Ø 460cm	500x500 cm
KITPR353W	Ø 350cm	400x400 cm



Filtro de cartucho  
(3,8 m³/h)  
Cartridge filter  
(3,8 m³/h)  
Filtre à cartouche  
(3,8 m³/h)  
Filtro a cartuccia  
(3,8 m³/h)

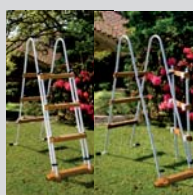

Escalera de seguridad  
2x3 Peldaños  
Safety Ladder  
2x3 Steps  
Echelle sécurité  
2x3 Marches  
Scala di sicurezza  
2x3 Gradini

dream pool serie

HAITI



KITPROV9188



	1000x550 cm	132 cm	56.111 l	620 kg	1/120x100	10m <sup>3</sup> /h	√	√	15	12	224626
KITPROV10288	1000x550 cm	132 cm	56.111 l	620 kg	1/120x100	10m <sup>3</sup> /h	√	√	15	12	224626
KITPROV9188	915x470 cm	132 cm	43.595 l	602 kg	1/120x80	8m <sup>3</sup> /h	√	√	15	12	220215
KITPROV8188	800x470 cm	132 cm	37.474 l	482 kg	1/120x80	7m <sup>3</sup> /h	√	√	15	12	224633
KITPROV7388	730x375 cm	132 cm	28.217 l	462 kg	1/120x80	5m <sup>3</sup> /h	√	√	15	12	220222
KITPROV6188	610x375 cm	132 cm	23.281 l	437 kg	1/90x80	5m <sup>3</sup> /h	√	√	15	12	221328

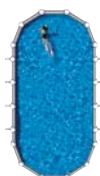

MEDIDA PISCINA  
POOL SIZE  
DIMENSIONS PISCINE  
MISURA PISCINA

ESPACIO NECESARIO  
NECESSARY SPACE  
ESPACE NECESSAIRE  
SPAZIO NECESSARIO

KITPROV10288	1000x550 cm	1040x670 cm
KITPROV9188	915x470 cm	955x590 cm
KITPROV8188	800x470 cm	850x590 cm
KITPROV7388	730x375 cm	770x495 cm
KITPROV6188	610x375 cm	650x495 cm



Liner PVC azul  
40/100  
PVC blue liner  
40/100  
Liner PVC bleu  
40/100  
Liner PVC blu  
40/100



Protectores de  
inyección  
Injection saver  
Protections moulées  
par injection  
Angolare di  
protezione



Perfilería de acero  
Steel profiles  
Poteaux et margelles  
acier  
Profili in acciaio



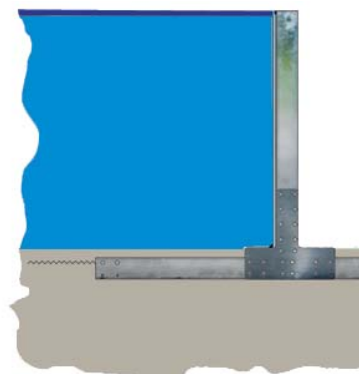

Viga de acero enterrada de 15x15cm que hace innecesarios los postes exteriores, obteniendo mejor aprovechamiento del jardín.

15x15cm buried steel beam makes unnecessary the outer posts, optimizing the use of the garden area.

Poteaux en acier à enterrer de 15x15 évitant des renforts apparents extérieurs, pour mieux profiter de l'espace du jardin.

Barra di acciaio interrata da 15x15 cm che non rende necessario l'utilizzo delle barre laterali; permette di poter sfruttare al meglio gli spazi del proprio giardino.



Sistema de omegas Omega system Renforts enterrés Sistema omega



Depuradora arena  
(Caudal grupo 10/8/7/5 m<sup>3</sup>/h)  
Sand filter  
(Flow group 10/8/7/5 m<sup>3</sup>/h)  
Filtre à sable  
(Débit groupe 10/8/7/5 m<sup>3</sup>/h)  
Filtro a sabbia  
Portata gruppo 10/8/7/5 m<sup>3</sup>/h



Escalera de seguridad  
Plataforma +2x3 Peldaños  
Safety Ladder  
Platform + 2x3 Steps  
Échelle sécurité  
Plateforme + 2x3 Marches  
Scala di sicurezza  
Piattaforma + 2x3 Gradini

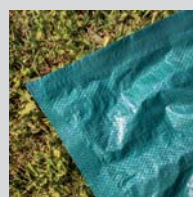

Tapiz protector  
(Polietileno)  
Floor tapestry  
(Polythene)  
Tapis de sol en feutre  
(Polyéthylène)  
Telo di protezione  
(Polietilene)

dream pool serie

# ATLANTIS



KITPROV918



	1000x550 cm	132 cm	56.111 l	498 kg	1/120x80	10m³/h	√	√	15	12	220239
KITPROV1028	1000x550 cm	132 cm	56.111 l	498 kg	1/120x80	10m³/h	√	√	15	12	220239
KITPROV918	915x470 cm	132 cm	43.595 l	480 kg	1/120x80	8m³/h	√	√	15	12	211978
KITPROV818	800x470 cm	132 cm	37.474 l	428 kg	1/120x80	7m³/h	√	√	15	12	211565
KITPROV738	730x375 cm	132 cm	28.217 l	335 kg	1/120x80	5m³/h	√	√	15	12	211985
KITPROV618	610x375 cm	132 cm	23.281 l	270 kg	1/90x80	5m³/h	√	√	15	12	211572
KITPROV508	500x300 cm	132 cm	23.281 l	260 kg	1/90x80	5m³/h	√	√	15	12	258119

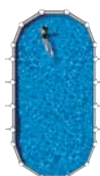

MEDIDA PISCINA  
POOL SIZE  
DIMENSIONS PISCINE  
MISURA PISCINA

ESPACIO NECESARIO  
NECESSARY SPACE  
ESPACE NECESSAIRE  
SPAZIO NECESSARIO

KITPROV1028	1000x550 cm	1040x670 cm
KITPROV918	915x470 cm	955x590 cm
KITPROV818	800x470 cm	850x590 cm
KITPROV738	730x375 cm	770x495 cm
KITPROV618	610x375 cm	650x495 cm
KITPROV508	500x300 cm	540x520 cm



Liner PVC azul  
40/100  
PVC blue liner  
40/100  
Liner PVC bleu  
40/100  
Liner PVC blu  
40/100



Protectores de  
inyección  
Injection saver  
Protections moulées  
par injection  
Angolare di  
protezione



Perfilería de acero  
Steel profiles  
Poteaux et margelles  
acier  
Profili in acciaio



KITPR558



	Ø	h	V	P	W	F	L	C	P	B	8412081
KITPR558	Ø550 cm	132 cm	27.798 l	243 kg	1/90x80	5m <sup>3</sup> /h	√	√	15	12	211589
KITPR458	Ø460 cm	132 cm	19.444 l	238 kg	1/90x80	5m <sup>3</sup> /h	√	√	15	12	211596
KITPR358	Ø350 cm	132 cm	11.250 l	184 kg	1/90x80	5m <sup>3</sup> /h	√	√	15	12	233864

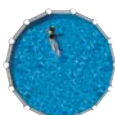

	MEDIDA PISCINA POOL SIZE DIMENSIONS PISCINE MISURA PISCINA	ESPACIO NECESARIO NECESSARY SPACE ESPACE NECESSAIRE SPAZIO NECESSARIO
KITPR558	Ø 550cm	600x600 cm
KITPR458	Ø 460cm	500x500 cm
KITPR358	Ø 350cm	400x400 cm



Depuradora arena  
(Caudal grupo 10/8/7/5 m<sup>3</sup>/h)  
Sand filter  
(Flow group 10/8/7/5 m<sup>3</sup>/h)  
Filtre à sable  
(Débit groupe 10/8/7/5 m<sup>3</sup>/h)  
Filtro a sabbia  
Portata gruppo 10/8/7/5 m<sup>3</sup>/h



Escalera de seguridad  
Plataforma +2x3 Peldaños  
Safety Ladder  
Platform + 2x3 Steps  
Échelle sécurité  
Plateforme + 2x3 Marches  
Scala di sicurezza  
Piattaforma + 2x3 Gradini

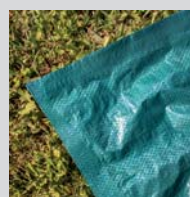

Tapiz protector  
(Polietileno)  
Floor tapestry  
(Polythene)  
Tapis de sol en feutre  
(Polyéthylène)  
Telo di protezione  
(Polietilene)

# dream pool serie AZORES



KITPROV5083



KITPROV5083

500x300 cm

132 cm

16.210 l

217 kg

1/90x80

3,8m<sup>3</sup>/h

√

15

12

258010

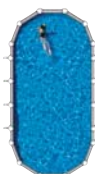

MEDIDA PISCINA  
POOL SIZE  
DIMENSIONS PISCINE  
MISURA PISCINA

ESPACIO NECESARIO  
NECESSARY SPACE  
ESPACE NECESSAIRE  
SPAZIO NECESSARIO

KITPROV5083

500x300 cm

540x520 cm



Liner PVC azul  
40/100  
PVC blue liner  
40/100  
Liner PVC bleu  
40/100  
Liner PVC blu  
40/100



Protectores de  
inyección  
Injection saver  
Protections moulées  
par injection  
Angolare di  
protezione



Perfilería de acero  
Steel profiles  
Poteaux et margelles  
acier  
Profili in acciaio



KITPR4583



8412081

	Ø460 cm	132 cm	19.444 l	167 kg	1/80x40	3,8m <sup>3</sup> /h	√	15	12	258027
KITPR4583	Ø460 cm	132 cm	19.444 l	167 kg	1/80x40	3,8m <sup>3</sup> /h	√	15	12	258027
KITPR3583	Ø350 cm	132 cm	11.250 l	156 kg	1/80x40	3,8m <sup>3</sup> /h	√	15	12	258034



MEDIDA PISCINA  
POOL SIZE  
DIMENSIONS PISCINE  
MISURA PISCINA

ESPACIO NECESARIO  
NECESSARY SPACE  
ESPACE NECESSAIRE  
SPAZIO NECESSARIO

KITPR4583	Ø 460cm	500x500 cm
KITPR3583	Ø 350cm	400x400 cm



Filtro de cartucho  
(3,8 m<sup>3</sup>/h)  
Cartridge filter  
(3,8 m<sup>3</sup>/h)  
Filtre à cartouche  
(3,8 m<sup>3</sup>/h)  
Filtro a cartuccia  
(3,8 m<sup>3</sup>/h)



Escalera de seguridad  
Plataforma +2x3 Peldaños  
Safety Ladder  
Platform + 2x3 Steps  
Échelle sécurité  
Plateforme + 2x3 Marches  
Scala di sicurezza  
Piattaforma + 2x3 Gradini

# dream pool serie **FIDJI**



KIT730ECO



	730x375 cm	120 cm	25.323 l	287 kg	1/90x80	4m <sup>3</sup> /h	√	15	12	211398
KIT730ECO	730x375 cm	120 cm	25.323 l	287 kg	1/90x80	4m <sup>3</sup> /h	√	15	12	211398
KIT610ECO	610x375 cm	120 cm	20.893 l	235 kg	1/80x60	3m <sup>3</sup> /h	√	15	12	211404
KIT500ECO	500x300 cm	120 cm	14.550 l	224 kg	1/80x60	3m <sup>3</sup> /h	√	15	12	231037



MEDIDA PISCINA  
POOL SIZE  
DIMENSIONS PISCINE  
MISURA PISCINA

ESPACIO NECESARIO  
NECESSARY SPACE  
ESPACE NECESSAIRE  
SPAZIO NECESSARIO

KIT730ECO	730x375 cm	770x595 cm
KIT610ECO	610x375 cm	650x595 cm
KIT500ECO	500x300 cm	540x520 cm



Liner PVC azul 30/100  
KIT730/KIT610: 40/100  
PVC blue liner 30/100  
KIT730/KIT610: 40/100  
Liner PVC bleu 30/100  
KIT730/KIT610: 40/100  
Liner PVC blu 30/100  
KIT730/KIT610: 40/100



Protectores de  
inyección  
Injection saver  
Protections moulées  
par injection  
Angolare di  
protezione



Perfilería de acero  
Steel profiles  
Poteaux et margelles  
acier  
Profili in acciaio



KIT350ECO



	Ø	Height	Capacity (l)	Weight (kg)	Box Size	Flow (m³/h)	✓	Pool Cover	Pool Liner	Barcode
KIT550ECO	Ø550 cm	120 cm	24.944 l	209 kg	1/80x60	4m³/h	✓	15	12	211411
KIT460ECO	Ø460 cm	120 cm	17.450 l	172 kg	1/80x60	3m³/h	✓	15	12	211428
KIT350ECO	Ø350 cm	120 cm	10.102 l	146 kg	1/80x60	3m³/h	✓	15	12	211435
KIT300ECO	Ø300 cm	120 cm	7.418 l	136 kg	1/80x60	3m³/h	✓	15	12	228754
KIT240ECO	Ø240 cm	120 cm	4.750 l	120 kg	1/80x60	3m³/h	✓	15	12	240831



	MEDIDA PISCINA POOL SIZE DIMENSIONS PISCINE MISURA PISCINA	ESPACIO NECESARIO NECESSARY SPACE ESPACE NECESSAIRE SPAZIO NECESSARIO
KIT550ECO	Ø 550cm	600x600 cm
KIT460ECO	Ø 460cm	500x500 cm
KIT350ECO	Ø 350cm	400x400 cm
KIT300ECO	Ø 300cm	350x350 cm
KIT240ECO	Ø 240cm	300x300 cm



Depuradora arena  
(Caudal grupo 3/4 m³/h)  
Sand filter  
(Flow group 3/4 m³/h)  
Filtre à sable  
(Débit groupe 3/4 m³/h)  
Filtro a sabbia  
Portata gruppo 3/4 m³/h



Escalera de seguridad  
2x3 Peldaños  
Safety Ladder  
2x3 Steps  
Echelle sécurité  
2x3 Marches  
Scala di sicurezza  
2x3 Gradini

dream pool serie

# VARADERO



KITPROV7070



	710x475 cm	120 cm	27.872 l	371 kg	1/90x80	4m <sup>3</sup> /h	√	√	15	12	211626
KITPROV7070	710x475 cm	120 cm	27.872 l	371 kg	1/90x80	4m <sup>3</sup> /h	√	√	15	12	211626
KITPROV6270	640x390 cm	120 cm	20.652 l	311 kg	1/90x80	4m <sup>3</sup> /h	√	√	15	12	211633
KITPROV4870	500x340 cm	120 cm	13.696 l	284 kg	1/90x80	4m <sup>3</sup> /h	√	√	15	12	231921



MEDIDA PISCINA  
POOL SIZE  
DIMENSIONS PISCINE  
MISURA PISCINA

ESPACIO NECESARIO  
NECESSARY SPACE  
ESPACE NECESSAIRE  
SPAZIO NECESSARIO

KITPROV7070	710x475 cm	755x510 cm
KITPROV6270	640x390 cm	700x430 cm
KITPROV5070	500x340 cm	540x380 cm



Liner PVC azul  
40/100  
PVC blue liner  
40/100  
Liner PVC bleu  
40/100  
Liner PVC blu  
40/100



Protectores de  
inyección  
Injection saver  
Protections moulées  
par injection  
Angolare di  
protezione



Perfilería de acero  
Steel profiles  
Poteaux et margelles  
acier  
Profili in acciaio



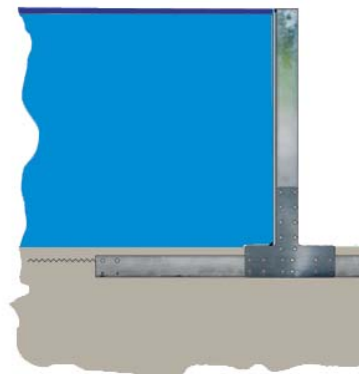

Viga de acero enterrada de 15x15cm que hace innecesarios los postes exteriores, obteniendo mejor aprovechamiento del jardín.

15x15cm buried steel beam makes unnecessary the outer posts, optimizing the use of the garden area.

Poteaux en acier à enterrer de 15x15 évitant des renforts apparents extérieurs, pour mieux profiter de l'espace du jardin.

Barra di acciaio interrata da 15x15 cm che non rende necessario l'utilizzo delle barre laterali; permette di poter sfruttare al meglio gli spazi del proprio giardino.



Sistema de omegas Omega system Renforts enterrés Sistema omega



Depuradora arena  
(Caudal grupo 4 m<sup>3</sup>/h)  
Sand filter  
(Flow group 4 m<sup>3</sup>/h)  
Filtre à sable  
(Débit groupe 4 m<sup>3</sup>/h)  
Filtro a sabbia  
Portata gruppo 4 m<sup>3</sup>/h

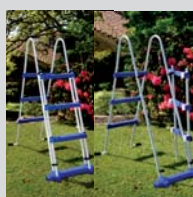

Escalera de seguridad  
2x3 Peldaños  
Safety Ladder  
2x3 Steps  
Échelle sécurité  
2x3 Marches  
Scala di sicurezza  
2x3 Gradini

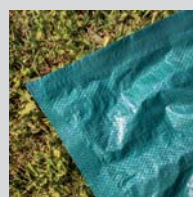

Tapiz protector  
(Polietileno)  
Floor tapestry  
(Polythene)  
Tapis de sol en feutre  
(Polyéthylène)  
Telo di protezione  
(Polietilene)

dream pool serie

# BORA BORA



KITPROV613



	610x375 cm	120 cm	20.893 l	210 kg	1/80x60	3,8m <sup>3</sup> /h	√	15	12	220437
KITPROV613	610x375 cm	120 cm	20.893 l	210 kg	1/80x60	3,8m <sup>3</sup> /h	√	15	12	220437
KITPROV503	500x300 cm	120 cm	14.550 l	205 kg	1/80x60	3,8m <sup>3</sup> /h	√	15	12	220260



MEDIDA PISCINA  
POOL SIZE  
DIMENSIONS PISCINE  
MISURA PISCINA

ESPACIO NECESARIO  
NECESSARY SPACE  
ESPACE NECESSAIRE  
SPAZIO NECESSARIO

KITPROV613	610x375 cm	650x595 cm
KITPROV503	500x300 cm	540x520 cm



Liner PVC azul 30/100  
KITPROV613: 40/100  
PVC blue liner 30/100  
KITPROV613: 40/100  
Liner PVC bleu 30/100  
KITPROV613: 40/100  
Liner PVC blu 30/100  
KITPROV613: 40/100



Protectores de  
inyección  
Injection saver  
Protections moulées  
par injection  
Angolare di  
protezione



Perfilería de acero  
Steel profiles  
Poteaux et margelles  
acier  
Profili in acciaio



KITPR453



	Ø	Height	Capacity	Weight	Box	Pump	Ladder	Filter	Barcode	
KITPR453	Ø460 cm	120 cm	17.450 l	149 kg	1/80x40	3,8m <sup>3</sup> /h	√	15	12	209005
KITPR353	Ø350 cm	120 cm	10.102 l	109 kg	1/80x40	3,8m <sup>3</sup> /h	√	15	12	209012
KITPR303	Ø300 cm	120 cm	7.418 l	94 kg	1/80x40	3,8m <sup>3</sup> /h	√	15	12	233901

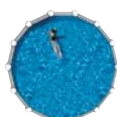

	MEDIDA PISCINA POOL SIZE DIMENSIONS PISCINE MISURA PISCINA	ESPACIO NECESARIO NECESSARY SPACE ESPACE NECESSAIRE SPAZIO NECESSARIO
KITPR453	Ø 460cm	500x500 cm
KITPR353	Ø 350cm	400x400 cm
KITPR303	Ø 300cm	350x350 cm



Filtro de cartucho  
(3,8 m<sup>3</sup>/h)  
Cartridge filter  
(3,8 m<sup>3</sup>/h)  
Filtre à cartouche  
(3,8 m<sup>3</sup>/h)  
Filtro a cartuccia  
(3,8 m<sup>3</sup>/h)

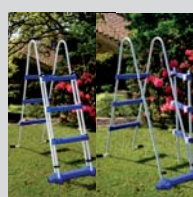

Escalera de seguridad  
2x3 Peldaños  
Safety Ladder  
2x3 Steps  
Echelle sécurité  
2x3 Marches  
Scala di sicurezza  
2x3 Gradini

# dream pool serie TENERIFE



8412081

	Ø	H	Volumen	Peso	Paquete	Filtración	Escalera	Peldaños	Código
KITWPR452E	Ø460 cm	90 cm	12.717 l	56 kg	8/120x80	2m³/h	√	3,5	241418
KITWPR352E	Ø350 cm	90 cm	7.693 l	47 kg	8/120x80	2m³/h	√	3,5	241401
KITWPR302	Ø300 cm	90 cm	6.358 l	44 kg	8/120x80	2m³/h	√	3,5	231044

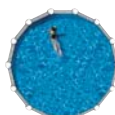

MEDIDA PISCINA  
POOL SIZE  
DIMENSIONS PISCINE  
MISURA PISCINA

ESPACIO NECESARIO  
NECESSARY SPACE  
ESPACE NECESSAIRE  
SPAZIO NECESSARIO

KITWPR452E	Ø 460cm	500x500 cm
KITWPR352E	Ø 350cm	400x400 cm
KITWPR302	Ø 300cm	350x350 cm



Liner PVC azul  
20/100  
PVC blue liner  
20/100  
Liner PVC bleu  
20/100  
Liner PVC blu  
40/100



Filtro de cartucho:  
2 m³/h  
Cartidge filter  
2 m³/h  
Filtre à cartouche  
2 m³/h  
Filtro a cartuccia  
2 m³/h

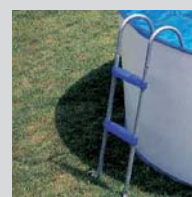

Escalera  
2x2 Peldaños  
Ladder  
2x2 Steps  
Échelle  
2x2 Marches  
Scala  
2x2 Gradini

dream pool serie

# FORMENTERA



KITWPR450E



	Dimensions	Depth	Volume	Weight	Box	Pump	Ladder	Cover	Filter	Barcode
KITWPR450E	Ø460 cm	90 cm	12.717 l	56 kg	8/120x80	2m <sup>3</sup> /h	√	3,5	3,5	241210
KITWPR350E	Ø350 cm	90 cm	7.693 l	47 kg	8/120x80	2m <sup>3</sup> /h	√	3,5	3,5	241203



	MEDIDA PISCINA POOL SIZE DIMENSIONS PISCINE MISURA PISCINA	ESPACIO NECESARIO NECESSARY SPACE ESPACE NECESSAIRE SPAZIO NECESSARIO
KITWPR450E	Ø 460cm	500x500 cm
KITWPR350E	Ø 350cm	400x400 cm

jet pool

serie

**JUNIOR**



## PISCINAS DE TUBO DE ACERO

**LINER:** Lámina de P.V.C. de alta resistencia. Soldadura por alta frecuencia. Con desagüe.

**ESTRUCTURA:** Metálica pintada en epoxy-poliéster atóxico - para mayor resistencia a la corrosión. Patas soldadas al codo que evitan la rotura. Bases de P.V.C. que mejoran la estabilidad de la piscina.

## STEEL FRAME POOL

**LINER:** high resistance PVC plate. High-frequency welding. Drain included.

**STRUCTURE:** Non toxic epoxy-polyester paint for higher corrosion resistance. Legs welded to elbow bends to prevent breaks. P.V.C. bottomed legs for increased pool stability.

## PISCINE TUBES EN ACIER

**LINER:** Liner P.V.C. À haute résistance. Soudure par haute fréquence. Système d'évacuation.

**STRUCTURE:** Métallique peinte en époxy-polyester non toxique, pour une meilleure Résistance à la corrosion pattes soudées au coude, pour éviter la cassure. Bases en pvc pour améliorer la stabilité de la piscine.







## PISCINE IN TUBI D'ACCIAIO

**LINER:** Lamina di P.V.C. ad alta resistenza. Saldatura ad alta frequenza. Con scarico..

**STRUTTURA:** Metallica dipinta in epoxi-poliestere per una maggiore resistenza alla corrosione. Struttura superiore saldata nelle giunture per evitare la rotture. Basi in P.V.C. che migliorano la stabilità della piscina.

WET230



							
WET230	Ø 215 cm	45 cm	1.215 l	8,5 kg	60/120x80	√	920238
WET200	190x190 cm	45 cm	1.450 l	10,3 kg	60/120x80	√	920221
Y25	125x125 cm	35 cm	500 l	5,7 kg	60/120x80	√	870199

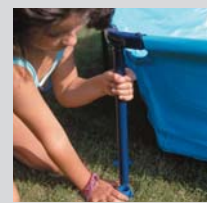
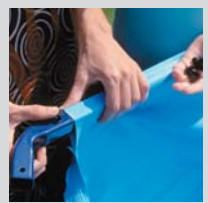

Estructura tubular  
 Desagüe  
 Tubular structure  
 Drain  
 Structure tubulaire  
 Système d'évacuation  
 Struttura tubolare  
 Scarico



## Leyenda Legend Légende Legenda

### **BX**

caja  
box  
box  
scatola

### **BXL**

caja con etiqueta  
box and label  
carton avec étiquette  
scatola con etichetta

### **CB**

cartoncillo  
cardboard wrap  
bande carton  
cartone

### **CBX**

caja litografiada  
colour box  
boîte de couleur  
scatola serigrafata

### **PB**

bolsa de plástico  
polybag  
sac plastique  
busta di plastica

### **PBH**

bolsa de plástico con cartoncillo  
polybag with header  
sac plastique avec bande carton  
sacchetto di plastica con cartone

### **BL**

blister  
blister  
blister  
blister

### **CS**

doble burbuja  
clamshell  
double coque  
doppio rivestimento

### **DIS**

display  
display  
display  
display



# complementos complements

COMPLEMENTOS	62	COMPLEMENTS
Cubiertas isotérmicas	64	Isothermic covers
Cubiertas de invierno	65	Winter covers
Mantas	66	Bottom protective blankets
Liners	67	Liners
Enrolladores de cubiertas	68	Telescopic cover rollers
Escaleras para piscinas enterradas	69	Inground pool ladders
Escaleras para piscinas sobre suelo	70	Above-ground pool ladders
Monoblocs de filtración	72	Filtration kit
Cargas filtrantes	74	Filter media
Skimmers	74	Skimmers
Filtros de Cartucho	75	Cartridge filter
Cartuchos	75	Cartridges
Bombas	76	Pumps
Local técnico	77	Technical room
Tratamiento de agua	78	Water treatment
Electrolisis de sal	78	Electrolysis of salt
Sistemas de desinfección y dosificación	80	Disinfection and dosing systems
Iluminación	81	Lighting
Calefacción	84	Heating systems
Calefacción solar	85	Solar heating system
Duchas	86	Showers
Repuestos	90	Spare parts

# complements complementi

COMPLEMENTS	62	COMPLEMENTI
Couvertures isothermes	64	Coperture isotermitiche
Couvertures pour l'hiver	65	Copertura invernale
Couvertures de protection du fond	66	Telo di protezione fondi
Liners	67	Liners
Enrouleurs de bâches	68	Avvolgitore
Échelles pour piscines enterrées	69	Scaletta per piscina interrata
Échelles pour piscines hors sol	70	Scaletta per piscina fuori terra
Platine de filtration	72	Filtro monoblocco
Médias filtrants	74	Carico filtrante
Skimmers	74	Skimmers
Epurateur a cartouche	75	Filtri a cartuccia
Cartouches	75	Cartucce
Pompes	76	Pompe
Local technique	77	Locale tecnico
Traitement d'eau	78	Trattamento acqua
Electrolyse de sel	78	Elettrolisi salina
Systèmes de dosage et de désinfection	80	Sistemi di dosaggio e disinfezione
Éclairage	81	Illuminazione
Chauffage	84	Riscaldamento
Chauffage solaire	85	Riscaldamento solare
Douches	86	Docce
Pièces de rechange	90	Ricambi accessori

## CUBIERTAS ISOTÉRMICAS ISOTHERMIC COVERS COUVERTURES ISOTHERMES COPERTURE ISOTHERMICHE



Material: Polietileno Matériel: Polyéthylène  
Material: Polythene Materiale: Polietilene

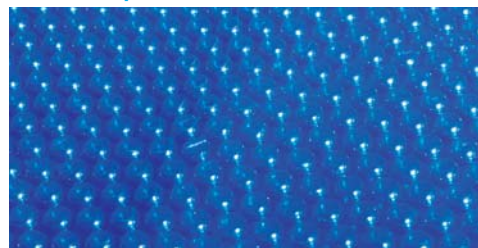

8412081

<b>CPROV700</b>	672x445	180 µ	-	-	710x475	-	-	PBH pack 1	205830
<b>CPROV600</b>	620x370	180 µ	-	-	640x390	-	-	PBH pack 1	205847
<b>CPROV500</b>	472x305	180 µ	-	-	500x340	-	-	PBH pack 1	205854
<b>CPROV1020</b>	995x545	180 µ	-	1000x550	-	-	-	PBH pack 1	220536
<b>CPROV915</b>	910x460	180 µ	-	915x470	-	-	-	PBH pack 1	980324
<b>CPROV810</b>	805x460	180 µ	-	810x470	-	-	-	PBH pack 1	205984
<b>CPROV730</b>	725x370	180 µ	-	730x375	-	-	-	PBH pack 1	980331
<b>CPROV610</b>	605x370	180 µ	-	610x375	-	-	-	PBH pack 1	205991
<b>CPROV505</b>	495x295	180 µ	-	500x300	-	-	-	PBH pack 1	221823
<b>CPR650</b>	640 ø	180 µ	-	-	-	ø 640	-	PBH pack 1	950303
<b>CPR550</b>	545 ø	180 µ	-	-	-	ø 550	-	PBH pack 1	940601
<b>CV450</b>	455 ø	180 µ	ø 550	-	-	ø 460	ø 450 ø 460	PBH pack 1	202525
<b>CPR400</b>	395 ø	180 µ	-	-	-	-	ø 400	PBH pack 1	940625
<b>CV350</b>	345 ø	180 µ	ø 450	-	-	ø 350	ø 350	PBH pack 1	202532
<b>CV300</b>	295 ø	180 µ	ø 350	-	-	ø 300	ø 300	PBH pack 1	202549
<b>CV250</b>	245 ø	180 µ	ø 300	-	-	ø 240	-	PBH pack 1	208565

**NEW**



### POOL HOUSE

REF. PH54

BXL PACK 1

5x4,33x2,50 m

8412081257532

#### TOLDO PISCINA

Dimensiones: 5,00 x 4,33 x 2,50 m

Material: Poliéster

Paneles laterales de PVC transparente  
3 puertas con cierre de cremallera

#### AUVENT DE PROTECTION

Dimensions : 5,00 x 4,33 x 2,50 m

Matériau : Polyester

Parois latérales en PVC transparent  
3 portes avec fermeture éclair

#### POOL HOUSE

Assembled size: 5,00 x 4,33 x 2,5m

Material: Polyester. Transparent PVC side walls. 3 doors with zipper close. Adaptable to 4m pools.

#### GAZEBO DI PROTEZIONE

Dimensioni: 5,00 x 4,33 x 2,50 m

Materiale: Poliestere

Pannelli laterali in PVC trasparente  
3 porte con chiusura a zip

**CUBIERTAS DE INVIERNO WINTER COVERS**  
**COUVERTURES POUR L'HIVER COPERTURA INVERNALE**



**Material: Polietileno**    **Matériel: Polyéthylène**  
**Material: Polythene**    **Materiale: Polietilene**



<b>CIPROV1001</b>	1115x660	100 g/m <sup>2</sup>	-	-	1000x550	-	-	-	CBX pack 3	221854
<b>CIPROV911</b>	1030x560	100 g/m <sup>2</sup>	-	-	915x470	-	-	-	CBX pack 3	208671
<b>CIPROV 821</b>	930x560	100 g/m <sup>2</sup>	-	-	800x470	710x475	-	-	CBX pack 3	208688
<b>CIPROV731</b>	820x460	100 g/m <sup>2</sup>	-	-	730x375	640x390	-	-	CBX pack 3	208695
<b>CIPROV611</b>	680x460	100 g/m <sup>2</sup>	-	-	610x375	500x340	-	-	CBX pack 3	208701
<b>CIPROV501</b>	610x410	100 g/m <sup>2</sup>	-	-	500x300	-	-	-	CBX pack 3	221861
<b>CIPR651</b>	730 ø	100 g/m <sup>2</sup>	-	-	-	-	ø 640	-	CBX pack 3	208718
<b>CIPR551</b>	640 ø	100 g/m <sup>2</sup>	-	-	-	-	ø 550	-	CBX pack 5	208725
<b>CIPR451</b>	540 ø	100 g/m <sup>2</sup>	-	ø 550	-	-	ø 460	ø 450 ø 460	CBX pack 5	208732
<b>CIPR401</b>	480 ø	100 g/m <sup>2</sup>	ø 440	ø 450	-	-	-	ø 400	CBX pack 5	208749
<b>CIPR351</b>	440 ø	100 g/m <sup>2</sup>	ø 360	ø 350 ø 360	-	-	ø 350	ø 350	CBX pack 5	208756
<b>CIPR301</b>	380 ø	100 g/m <sup>2</sup>	-	-	-	-	ø 300	-	CBX pack 5	220567
<b>CIPR241</b>	330 ø	100 g/m <sup>2</sup>	-	-	-	-	ø 240	-	CBX pack 5	220574

## MANTAS PROTECTORAS BOTTOM PROTECTIVE BLANKET POUR LE SOL DES PISCINES COUVERTURES DE PROTECTION DU FOND TAPPETO DI PROTEZIONE



Material: Poliéster  
Material: Polyester  
Matériel: Polyester  
Materiale: Poliestere



<b>MPROV1100</b>	1100x600	110 g/m <sup>2</sup>	-	-	-	1000x550	-	-	-	PBH pack 1	214528
<b>MPROV915</b>	950x500	110 g/m <sup>2</sup>	-	-	-	915x470	-	-	-	PBH pack 1	980256
<b>MPROV810</b>	825x500	110 g/m <sup>2</sup>	780x400	-	780x400	810x470	710x475	-	-	PBH pack 1	206004
<b>MPROV730</b>	750x400	110 g/m <sup>2</sup>	660x280	-	660x280	730x375	640x390	-	-	PBH pack 1	980263
<b>MPROV610</b>	625x400	110 g/m <sup>2</sup>	530x280	-	530x280	610x375	500x340	-	-	PBH pack 1	206011
<b>MPROV500</b>	525x325	110 g/m <sup>2</sup>	-	-	-	500x300	-	-	-	PBH pack 1	231075
<b>MPR650</b>	650x650	110 g/m <sup>2</sup>	-	-	-	-	-	ø 640	-	PBH pack 1	960111
<b>MPR550</b>	550x550	110 g/m <sup>2</sup>	-	-	ø 550	-	-	ø 550	-	PBH pack 1	960128
<b>MPR450</b>	550x500	110 g/m <sup>2</sup>	-	ø 440	ø 450	-	-	ø 460 ø 450	ø 460	PBH pack 1	960135
<b>MPR400</b>	400x400	110 g/m <sup>2</sup>	-	ø 360	-	-	-	ø 350	ø 400	PBH pack 1	960142
<b>MPR350</b>	500x500	110 g/m <sup>2</sup>	-	-	ø 350	-	-	ø 350 ø 300	ø 350	PBH pack 1	960159
<b>MPR250</b>	250x250	110 g/m <sup>2</sup>	-	-	ø 240	-	-	ø 240	-	PBH pack 1	208572



### FLOOR PROTECTOR

REF. MPF509

CBX PACK 14

50x50cmx4,5mm



8412081252001

#### PROTECTOR DE SUELO DE PISCINA

Polietileno duradero  
Ofrece una protección adicional para el fondo de la piscina  
Contiene 9 piezas de 50x50cm

#### POOL FLOOR PROTECTOR

Durable Polyethylene  
Provides added protection for pool floors  
Package contains 9 pieces of 50x50cm

#### PROTECTEUR DE SOL DE PISCINE

Polyéthylène résistant  
Fournit une protection supplémentaire pour les sols de piscines  
L'emballage contient 9 pièces 50x50cm

#### PROTEZIONE PER IL FONDO DELLA PISCINA

In polietilene resistente  
Evita che il fondo della piscina si danneggi  
Il package include 9 pezzi, 50x50cm

## LINERS LINERS FONDS LINERS



**Liner azul (AZ)**  
**Blue liner (AZ)**  
**Liner bleu (AZ)**  
**Liner blu (AZ)**

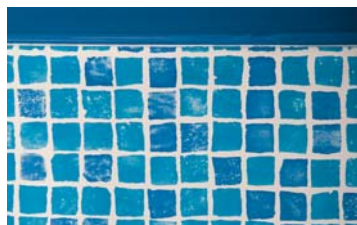

**Liner gresite (GR)**  
**Gresite liner (GR)**  
**Liner carrelage (GR)**  
**Liner mosaicato (GR)**



**Sistema colgante (SC)**  
**Hanging system (SC)**  
**Rail d'accroche (SC)**  
**Con barra di aggancia-  
mento (SC)**

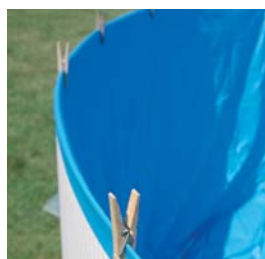

**Sistema overlap (OV)**  
**Overlap system (OV)**  
**Système à recouvrement (OV)**  
**Sistema overlap (OV)**



8412081

<b>FPR557</b>	GR	SC	Ø 550	132cm	50/100	258249
<b>FPR457</b>	GR	SC	Ø 460	132cm	50/100	258256
<b>FPR357</b>	GR	SC	Ø 350	132cm	50/100	258263
<b>FPR558</b>	AZ	SC	Ø 550	132cm	40/100	214504
<b>FPR458</b>	AZ	SC	Ø 460	132cm	40/100	224121
<b>FPR358</b>	AZ	SC	Ø 350	132cm	40/100	233918
<b>FPR551</b>	AZ	SC	Ø 550	120cm	40/100	950648
<b>FPR451</b>	AZ	SC	Ø 460	120cm	40/100	980485
<b>FPR352</b>	AZ	SC	Ø 350	120cm	40/100	200576
<b>FPR301</b>	AZ	SC	Ø 300	120cm	40/100	216027
<b>FPR241</b>	AZ	SC	Ø 240	120cm	40/100	203010
<b>FPR354</b>	AZ	SC	Ø 350	90cm	30/100	201177
<b>FSP450</b>	AZ	OV	Ø 450	90cm	20/100	990217
<b>FSP400</b>	AZ	OV	Ø 400	90cm	20/100	990224
<b>FSP350</b>	AZ	OV	Ø 350	90cm	20/100	990231
<b>FSP300</b>	AZ	OV	Ø 300	90cm	20/100	203249
<b>FWPR30</b>	AZ	OV	Ø 300	90cm	20/100	201191



8412081

<b>FPROV917</b>	GR	SC	915x470	132cm	50/100	258195
<b>FPROV827</b>	GR	SC	800x470	132cm	50/100	258201
<b>FPROV737</b>	GR	SC	730x375	132cm	50/100	258218
<b>FPROV617</b>	GR	SC	610x375	132cm	50/100	258225
<b>FPROV517</b>	GR	SC	500x300	132cm	50/100	258232
<b>FPROV1028</b>	AZ	SC	1000x550	132cm	40/100	224169
<b>FPROV918</b>	AZ	SC	915x470	132cm	40/100	214511
<b>FPROV818</b>	AZ	SC	800x470	132cm	40/100	224091
<b>FPROV738</b>	AZ	SC	730x375	132cm	40/100	224107
<b>FPROV618</b>	AZ	SC	610x375	132cm	40/100	224114
<b>FPROV707</b>	AZ	SC	700x450	120cm	40/100	204338
<b>FPROV627</b>	AZ	SC	625x375	120cm	40/100	204345
<b>FPROV507</b>	AZ	SC	500x310	120cm	40/100	204352
<b>FPROV915</b>	AZ	SC	915x470	120cm	40/100	980270
<b>FPROV810</b>	AZ	OV	800x470	120cm	40/100	206059
<b>FPROV730</b>	AZ	OV	730x375	120cm	40/100	980287
<b>FPROV610</b>	AZ	OV	610x375	120cm	40/100	206066
<b>FPROV500</b>	AZ	OV	500x300	120cm	40/100	221878

**ENROLLADORES DE CUBIERTAS TELESCOPIC COVER ROLLERS**  
**ENROULEURS DE BÂCHES AVVOGLITORE PER PISCINE**



REF. 90171

CBX PACK 1

8427370901713

**Enrollador piscinas enterradas**

Enrollador de cubierta para piscinas enterradas. Ofrece un desarrollo máximo de 5,50m. Ideal para piscinas redondas, cuadradas u ovaladas. Contiene tubos redondos en aluminio anodizado, un volante ergonómico con empuñadura giratoria así como un kit para atar la cubierta.

**Cover roller for inground pools**

Winder cover for in ground pools. Unfolds to a maximum length of 5.50 m. Suitable for round, square or oval swimming pools. Includes round anodised aluminium tubes, an ergonomic hand wheel with revolving handle as well as a kit to attach it to the cover.

**Enrouleur pour piscines hors-sol**

Enrouleur de bâche pour piscines enterrées. Il offre un développement maximum de 5,50m. Il convient aux piscines rondes, carrées ou ovales. Il est équipé de tubes ronds en aluminium anodisés, d'un volant ergonomique avec poignée tournante et d'un kit d'attache pour bâche. Cet enrouleur est livré en un seul colis, packaging couleur.

**Avvolgitore per piscine interrata**

Avvolgitore "grandi ruote" per piscine interrata. Si srotola fino a un massimo di 5.50m. Adatto per le piscine tonde, quadrate e ovali. Contiene un tubo in alluminio anodizzato, una ghiera ergonomica con una impugnatura rotatoria e un kit per fissare la copertura. Consegnato in un unico imballo.



REF. 40135

CBX PACK 2

8427370401350

**Enrollador piscinas elevadas**

El Enrollador ofrece un desarrollo máximo de 6,5m. Se ata fácilmente a las "playas" de la piscina con 2 placas atornilladas. El uso del enrollador permite una mejor conservación de la cubierta. Incluido: Conectores para piscinas tubulares.

**Cover roller for above-ground pools**

The Winder unfolds to a maximum length of 6.5 m. It can be easily attached to the "playa" finishing pieces of the pool using 2 bolted plates. The use of the winder enables a better conservation of the cover. Included: Connectors for tubular pools.

**Enrouleur pour piscines hors-sol**

Enrouleur offrant un développement maximum de 6,5m. Il se fixe facilement sur les 2 margelles de la piscine grâce à ses 2 plaques vissées. L'utilisation de l'enrouleur permet de conserver la bâche dans de bonnes conditions. Inclus: Connecteurs pour piscines tubulaires.

**Avvolgitore per piscine fuoriterra**

Avvolgitore che si srotola fino a un massimo di 6.5 m. Si fissa facilmente alla "bordo" della piscina con 2 placche con viti. L'utilizzo dell'avvolgitore permette una migliore conservazione della copertura.

**ESCALERAS PARA PISCINA ENTERRADA INGROUND POOL LADDERS**  
**ÉCHELLES POUR PISCINES ENTERRÉES SCALETTA PER PISCINA INTERRATA**



**STANDARD**

REF. 40272

BXL PACK 1

8412081250762

Escalera STANDARD para piscina enterrada de 4 peldaños Inox.

Stainless steel STANDARD inground pool ladder - 4 steps.

Échelle modèle STANDARD acier inoxydable pour piscine enterrée - 4 marches

Scaletta STANDARD per piscina interrata da 4 gradini – Inox



**STANDARD**

REF. 40110

BXL PACK 1

8427370401107

Escalera STANDARD para piscina enterrada de 3 peldaños Inox.

Stainless steel STANDARD inground pool ladder - 3 steps.

Échelle modèle STANDARD acier inoxydable pour piscine enterrée - 3 marches

Scaletta STANDARD per piscina interrata da 3 gradini – Inox

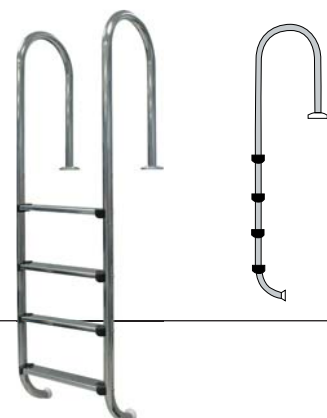

**WALL**

REF. 40274

BXL PACK 1

8412081250779

Escalera MURO para piscina enterrada de 4 peldaños – Inox

Stainless steel inground pool WALL ladder - 4 steps

Échelle MURALE acier inoxydable pour piscine enterrée - 4 marches

Scaletta MURO per piscina interrata da 4 gradini – Inox

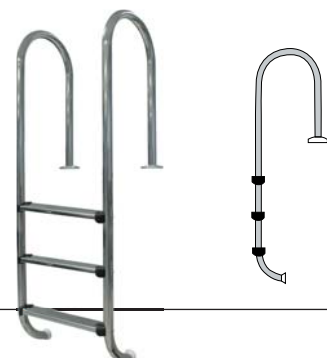

**WALL**

REF. 40273

BXL PACK 1

8412081250786

Escalera MURO para piscina enterrada de 3 peldaños – Inox

Stainless steel inground pool WALL ladder - 3 steps

Échelle MURALE acier inoxydable pour piscine enterrée - 3 marches

Scaletta MURO per piscina interrata da 3 gradini – Inox

**ESCALERAS PARA PISCINA SOBRE SUELO ABOVE-GROUND POOL LADDERS**  
**ÉCHELLES POUR PISCINES HORS SOL SCALETTA PER PISCINA FUORI TERRA**



**INOX**

REF. AR11680

BXL PACK 1

8412081231082

Escalera de acero inoxidable 142cm  
2x4 peldaños + plataforma

Échelle acier inoxydable 142cm  
2x4 marches + plateforme

Stainless steel ladder 142cm  
2x4 steps + platform

Scala in acciaio inossidabile 142cm  
2x4 gradini + piattaforma



**SAFETY**

REF. ES1150

BXL PACK 1

8412081233765

Escalera de seguridad 134cm  
2x3 peldaños + plataforma

Échelle sécurité 134cm  
2x3 marches + plateforme

Safety ladder 134cm  
2x3 steps + platform

Scala di sicurezza 134cm 2x3  
gradini + piattaforma



**SAFETY**

REF. ES1100

BXL PACK 1

8412081233772

Escalera de seguridad 120cm  
2x3 peldaños

Échelle sécurité 120cm  
2x3 marches

Safety ladder 120cm  
2x3 steps

Scala di sicurezza 120cm  
2x3 gradini





**NEW**



**STANDARD**

REF. ET1300

BXL PACK 1

8412081259031

Escalera 142cm  
2x3 peldaños + plataforma

Stainless 142cm  
2x3 steps + platform

Échelle 142cm  
2x3 marches + plateforme

Scala 142cm  
2x3 gradini + piattaforma



**STANDARD**

REF. ET1200

BXL PACK 1

8412081242422

Escalera tipo tijera 120cm  
2x3 peldaños

Ladder 120cm  
2x3 steps

Échelle 120cm  
2x3 marches

Scala 120 cm  
2x3 gradini



**STANDARD**

REF. AR109

BXL PACK 1

8412081242422

Escalera tipo tijera 98cm  
2x2 peldaños

Ladder 98cm  
2x2 steps

Échelle 98cm  
2x2 marches

Scala 98cm  
2x2 gradini

## MONOBLOCS DE FILTRACIÓN FILTRATION KITS ENSEMBLES DE FILTRATION FILTRO MONOBLOCCO

Las impurezas quedan retenidas en el medio filtrante en el interior de la cuba. Son muy compactos, fáciles de instalar, utilizar y no requieren especial atención. Incorporan un prefiltro para retener las partículas excesivamente grandes y evitar dañar la bomba (\*). Gracias a su válvula selectora (5/6/7 vías dependiendo del modelo), permiten realizar diferentes funciones: autolimpiado, filtración, vaciado... Los filtros FA6100 / FA6080 / FA6070 / FA6050 / FA6040 / FA6030 están certificados con la norma francesa NF P 90-318 que garantiza que cumplen con las normativas de seguridad establecidas.

Impurities are held by the filter media inside the tank. Sand filters are compact sized, easy to install and use and special care is not required. They include a prefilter to hold the largest particles to prevent pump from any damage (\*). Thanks to their multiport valves (5/6 ways depending on the version), different functions can be carried out: self-cleaning, filtration, emptying... Filters FA6100 / FA6080 / FA6070 / FA6050 / FA6040 / FA6030 are certified with the standard French NF P 90-318 ensuring that they comply with the safety regulations set.



REF. FA6100



REF. FA6080



REF. FA6070



REF. FA6050



REF. FA6040



REF. FA6030



W

HP



8412081

	Ø	Flow rate	W	HP	Weight	Units	Packaging	Barcode
<b>FA6100</b>	Ø 600 mm	10.000 l/h	485 W	0,66 CV/HP	±130 kg	6	<b>BXL</b> pack 1	233857
<b>FA6080</b>	Ø 500 mm	8.000 l/h	630 W	0,86 CV/HP	±90 kg	6	<b>BXL</b> pack 1	233840
<b>FA6070</b>	Ø 430 mm	7.000 l/h	230 W	0,31 CV/HP	±68 kg	6	<b>BXL</b> pack 1	233833
<b>FA6050</b>	Ø 380 mm	5.000 l/h	180 W	0,24 CV/HP	±46 kg	5	<b>BXL</b> pack 1	233826
<b>FA6040</b>	Ø 380 mm	4.000 l/h	125 W	0,17 CV/HP	±46 kg	5	<b>BXL</b> pack 1	233819
<b>FA6030</b>	Ø 300 mm	3.000 l/h	125 W	0,17 CV/HP	±23 kg	5	<b>BXL</b> pack 1	233802

# compléments **complementi**

Les impuretés sont retenues dans le média filtrant à l'intérieur de la cuve. Ces filtres sont très compacts et très faciles à installer et à utiliser, sans grandes exigences. Le filtre est muni d'un pré filtre qui retient les particules excessivement grandes pour éviter d'endommager la pompe (\*). Sa vanne multivoie (5/6 voies, suivant le modèle), permet de réaliser diverses fonctions: auto nettoyage, filtrage, vidange... Les filtres FA6100 / FA6080 / FA6070 / FA6050 / FA6040 / FA6030 sont certifiés par la norme française NF P 90-318 garantissant qu'ils respectent les réglementations établies en matière de sécurité.

Le impurità rimangono intrappolate nelle cariche filtrante all'interno del cestello. Sono molto compatti, facili da installare e da utilizzare e non richiedono cure particolari. Sono composti da un prefiltro per trattenere le particelle eccessivamente grandi ed evitare il danneggiamento della pompa(\*). Grazie alla valvola selettiva della quale sono dotati (5/6/7 uscite a seconda del modello), consentono diverse funzioni: autopulizia, filtrazione, svuotamento... I filtri FA6100 / FA6080 / FA6070 / FA6050 / FA6040 / FA6030 sono certificati dalla normativa francese NF P 90-318 che garantisce la loro conformità alle normative di sicurezza vigenti.



**W**

**HP**



	Ø	Flow	W	HP	Weight	Quantity	Packaging	Code
<b>FS500</b>	500 mm	8.000 l/h	550 W	0,75 CV/HP	±85 kg	5	<b>BXL pack 1</b>	252339
<b>FS400T</b>	400 mm	6.000 l/h	230 W	0,34 CV/HP	±35 kg	5	<b>BXL pack 1</b>	252322
<b>FS400</b>	400 mm	6.000 l/h	230 W	0,31 CV/HP	±35 kg	5	<b>BXL pack 1</b>	257495
<b>FS300</b>	300 mm	4.000 l/h	180 W	0,24 CV/HP	±20 kg	5	<b>BXL pack 1</b>	252315
<b>FS300NP</b>	300 mm	4.000 l/h	180 W	0,24 CV/HP	±20 kg	5	<b>BXL pack 1</b>	257488

## CARGAS FILTRANTES FILTER MEDIA MÉDIAS FILTRANTS CARICO FILTRO

REF. AR200

PB PACK 1

8412081960180

Arena - Silex 25kg. Granulometría 0,4-0,8.  
Sable - Silex 25kg. Granulométrie 0,4-0,8.

Sand - Silex 25 kg. Grain size 0,4-08.  
Sabbia - Silex 25kg. Granulometria 0,4-0,8.



REF. VF025

PB PACK 1

8412081240848

Vidrio filtrante saco 25kg  
Granulometría 0,5 - 1 mm  
Verre filtrant 25kg  
Granulométrie 0,5 - 1 mm

Glass filter media 25 kg  
Grain size 0,5 - 1 mm  
Vetro filtrante 25kg  
Granulometria 0,5 - 1 mm



## SKIMMERS SKIMMERS SKIMMERS SKIMMERS

REF. AR100

BXL PACK 1

8412081950396

Skimmer + boquilla de impulsión  
Skimmer + buse de refoulement  
Skimmer + return fitting  
Skimmer + bocchetta

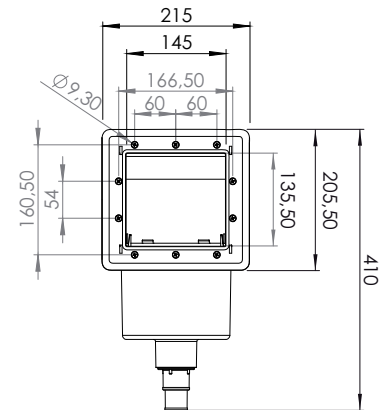

REF. AR100W

BXL PACK 1

8412081233192

Skimmer + boquilla de impulsión  
Skimmer + buse de refoulement  
Skimmer + return fitting  
Skimmer + bocchetta



REF. 042734

DIS PACK 36

3760015880048

### Water Lily

Colocado en la superficie del agua en el interior de la cesta skimmer, absorbe y retiene las materias grasas acumuladas por la circulación del agua.

### Water Lily

Posé à la surface de l'eau dans le panier de skimmer, Water Lily absorbe et retient les substances grasses.

### Water Lily

Placed in the basket skimmer, absorbs and retains all oily substances brought through by the circulating water.

### Water Lily

Posta sulla superficie dell'acqua nel cestello dello skimmer, assorbe e trattiene le sostanze grasse raccolte grazie alla circolazione dell'acqua.



## FILTROS DE CARTUCHO **CARTRIDGE FILTER** EPURATEUR À CARTOUCHE **FILTRI A CARTUCCIA**

Están especialmente concebidos para piscinas con un volumen de agua medio-inferior. Son muy sencillos de utilizar y su mantenimiento se limita a la limpieza o sustitución del cartucho o filtro de recambio, cuando éste ha quedado obstruido por la excesiva carga de suciedad.

Ils sont spécialement conçus pour les piscines d'un volume d'eau moyen inférieur. Ils sont très faciles à utiliser et l'entretien se limite au nettoyage ou au remplacement de la cartouche ou du filtre, quand il est bouché par un excès de saletés.

Specially designed for medium-low water volume pools. Cartridge filters are very easy to use and their maintenance is limited to the cartridge cleaning or replacement when dirt is blocking it.

Pensati specialmente per piscine con un volume di acqua medio-basso. Sono molto semplici da usare e la manutenzione si limita alla pulizia o sostituzione della cartuccia o della cartuccia di ricambio, quando questa è ostruita da eccessive impurità.



REF. AR125



REF. AR124  
REF. AR121E



W



AR125	3.800 l/h	70 W	AR82	BXL pack 1	970318
AR124	3.800 l/h	70 W	AR82	BXL pack 1	203164
AR121E	2.000 l/h	72 W	AR86	BXL pack 1	210193

## CARTUCHOS **CARTRIDGES** CARTOUCHES **CARTUCCIA**



REF. AR79

Cartucho tipo A piscina autoportante  
Type A Cartridge inflatable pool  
Cartouche de type A piscine autoportante  
Cartuccia tipo A piscina autoportante



REF. 90182

Limpiador de cartucho de filtro  
Filter cartridge cleaner  
Nettoyeur de cartouche de filtre  
Pistola per pulire le cartucce



REF. AR86

Cartucho  
Cartouche  
Cartridge  
Cartuccia



AR86	AR82	CS pack 12	203409
AR82	AR82	CS pack 12	970325
AR89	AR86	CS pack 12	217017
AR79	AR82	PB pack 18	241708

## BOMBAS PUMPS POMPES POMPE

Gama de bombas autoaspirantes GRE con potencias comprendidas entre 1/3 CV y 2 CV. Se trata de bombas centrifugas de una sola etapa, autocebantes, concebidas para uso con un sistema de filtración de piscina.

Gamme de pompes GRE, avec des puissances comprises entre 1/3 CV et 2 CV. Il s'agit de pompes centrifuges, auto-amorçantes, conçues pour une utilisation avec un système de filtration de piscine.

The self-priming pump range GRE emits power between 1/3 CV and 2 CV. Centrifugal pumps are single stage, self-priming pumps designed for use in a swimming pool filtration systems.

Gamma di pompe autoaspiranti GRE con potenze comprese tra 1/3 CV e 2 CV. Si tratta di pompe centrifughe monostadio, autoadescenti, concepite per l'uso con un sistema di filtrazione per piscina.

### PREMIUM

REF. PP200	CBX PACK 1		8412081237589
REF. PP150	CBX PACK 1		8412081237596
REF. PP100	CBX PACK 1		8412081237602



Curvas de rendimiento hidráulico  
Hydraulic performance curves  
Courbes de performances hydrauliques  
Curve delle prestazioni idrauliche

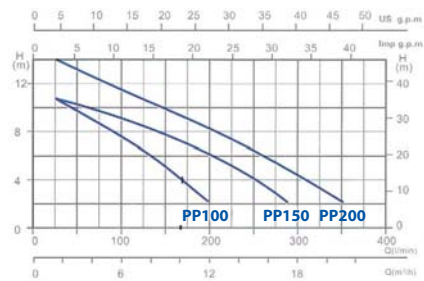

### COMFORT

REF. PP075	CBX PACK 1		8412081237619
REF. PP050	CBX PACK 1		8412081237626
REF. PP030	CBX PACK 1		8412081237633



Curvas de rendimiento hidráulico  
Hydraulic performance curves  
Courbes de performances hydrauliques  
Curve delle prestazioni idrauliche

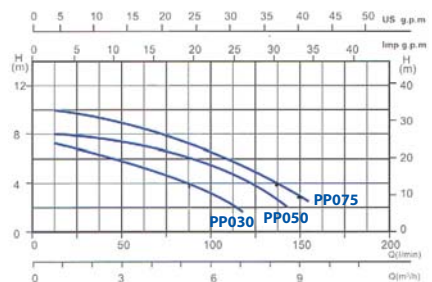

HP

W



max.



Model	HP	W	Flow (l/h)	Capacity (m³)	Pool Diameter (mm)	Product Code
PP200	2 CV/HP	1600 W	27.000 l/h	170m³	Ø 800 mm	237589
PP150	1,5 CV/HP	1100 W	22.000 l/h	135m³	Ø 700 mm	237596
PP100	1 CV/HP	900 W	20.000 l/h	100m³	Ø 600 mm	237602
PP075	3/4 CV/HP	550 W	9.500 l/h	65m³	Ø 500 mm	237619
PP050	1/2 CV/HP	450 W	8.500 l/h	50m³	Ø 400 mm	237626
PP030	1/3 CV/HP	250 W	7.000 l/h	35m³	Ø 300 mm	237633



Curvas de rendimiento hidráulico  
Hydraulic performance curves  
Courbes de performances hydrauliques  
Curve delle prestazioni idrauliche

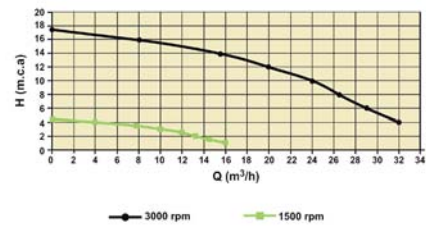

## PUMP

REF. PVV150 BX PACK 1

8412081250755

Bomba de velocidad variable.  
Potencia entre 0,75CV y 1,5CV  
Para todo tipo de piscinas.

Variable speed pump between  
0,75 HP and 1,5 HP.  
All types of pools.

Pompe à double vitesse d'une  
puissance entre 0,75CV et  
1,5CV. Convient pour tout type  
de piscines.

Pompa a velocità variabile.  
Potenza tra 0,75CV e 1,5CV.  
Tutti i tipi di piscine.



REF. CCBDV BX PACK 1

8412081250946

Armario de maniobra para  
bomba de 2 velocidades PVV150

Electrical cabinet/programmer  
for ref. PVV150

Armoire électrique pour  
pompe bi-vitesse PVV150.

Quadro Elettrico di controllo per  
Pompa di Calore a due velocità

## TECHNICAL ROOM

REF. ARNP30

BXL PACK 1

8412081227672



### LOCAL TÉCNICO

Local técnico fabricado en madera  
de pino nórdico, tratamiento nivel IV  
clase V. Con apertura frontal y superior.  
Incluye troquelado para conexiones. De  
fácil montaje (se sirve desmontado).  
Medidas int.: 107x73x91cm. No incluye  
filtro.

### LOCAL TECHNIQUE

Local technique en pin du Nord,  
traitement niveau IV classe V. Avec  
ouverture frontale et supérieure. Inclut  
ouverture pour connexions. Montage  
facile (livré démonté). Dimensions  
intérieures : 107x73x91cm. N'inclut pas  
le filtre.

### TECHNICAL ROOM

Technical room made of nordic pine  
wood with level IV class V treatment.  
Upper and front opening. Connection  
holes included. Easy to assemble (served  
dismantled). Inside measurements:  
107x73x91 cm. Filtration equipment not  
included.

### LOCALE TECNICO

Locale tecnico in legno di pino nordico,  
trattamento livello IV classe V. Con  
apertura frontale e superiore. Include  
stampigliatura per connessioni. Di  
facile montaggio (si fornisce smontato).  
Misure int.: 107x73x91cm. Filtro non  
incluso.

**TRATAMIENTO DE AGUA WATER TREATMENT**  
**TRAITEMENT DE L'EAU TRATTAMENTO ACQUA**

**Electrolisis de sal**

Los cloradores por electrolisis de sal generan cloro para la desinfección de la piscina a partir de sal. La electrolisis de sal tiene varias ventajas: genera y dosifica automáticamente el cloro en la piscina, evita el almacenamiento y la manipulación de producto químico y es totalmente seguro, ya que sólo utiliza sal común.

**Electrolyse au sel**

Les chlorinateurs par électrolyse au sel génèrent du chlore pour la désinfection de la piscine grâce au sel. L'électrolyse au sel présente plusieurs avantages : Elle génère et dose automatiquement le niveau de chlore dans la piscine, évite le stockage et la manipulation de produits chimiques et est complètement sûre, étant donné qu'elle n'emploie que du sel commun.

**Electrolisis of salt**

Through electrolysis of salt, the chlorinators generate chlorine and salt to disinfect the swimming pool. The electrolysis of salt has various advantages: Generating and automatically dosing the chlorine in the swimming pool, avoids the handling and storage of chemical products and it completely safe, using only sodium chloride.

**Elettrolisi salina**

I clorinatori per elettrolisi salina producono cloro per la disinfezione della piscina partendo dal sale. L'elettrolisi salina ha diversi vantaggi: produce e provvede al dosaggio automatico del cloro nella piscina, evita l'immagazzinamento e l'uso di prodotti chimici ed è del tutto sicura in quanto fa uso del sale comune.



Ref. EES080PH  
 BX PACK 1  
 8412081250663

Ref. EES050PH  
 BX PACK 1  
 8412081250670

Ref. EES025PH  
 BX PACK 1  
 8412081250687



Ref. EES080  
 BX PACK 1  
 8412081240800

Ref. EES050  
 BX PACK 1  
 8412081240794

Ref. EES025  
 BX PACK 1  
 8412081240787

Electrolisis de sal para piscinas enterradas Generación automática de cloro y dureza del agua. Inversión automática de polaridad. Apta para temperatura de agua superior a 15°C y un pH entre 7,0 y 7,2.

Chlorinateur pour piscines enterrées Production automatique de chlore et augmentation de la dureté de l'eau. Inversion automatique de la polarité. Adapté à la température de l'eau supérieure à 15 °c et un pH compris entre 7.0 et 7.2.

Salt chlorinator for in-ground pools Automatic chlorine and water hardening creation. Automatic polarity reversal. Suitable for water temperatures above 15 °C and a pH reading between 7.0 and 7.2.

Clorinatore di piscine interraste Generazione automatica di cloro e durezza dell'acqua. Esclusivamente per piscine interraste. Inversione di polarità automatica. Adatto per acque con temperature superiori a 15°C e pH tra 7,0 e 7,2.



	<b>EES025PH EES025</b>	<b>EES050PH EES050</b>	<b>EES080PH EES080</b>
	Hasta 25 m <sup>3</sup> Jusqu'à 25 m <sup>3</sup> Until 25 m <sup>3</sup> Fino a 25 m <sup>3</sup>	Hasta 50 m <sup>3</sup> Jusqu'à 50 m <sup>3</sup> Until 50 m <sup>3</sup> Fino a 50 m <sup>3</sup>	Hasta 80 m <sup>3</sup> Jusqu'à 80 m <sup>3</sup> Until 80 m <sup>3</sup> Fino a 80 m <sup>3</sup>
Tensión de servicio Standard working voltage Tension de service standard Tensione di lavoro	230 V AC, 50 Hz./60 Hz.		
Salida (dc) Output (dc) Sortie (dc) Uscita (c.c.)	3.5 A x 2	6 A x 2	3.5 A x 6
Producción (g/h) Production (g/h) Production (g/h) Produzione (g/h)	6 - 7	10-12	17-21
Capacidad piscina (m <sup>3</sup> ) Pool volume (m <sup>3</sup> ) Capacité piscine (m <sup>3</sup> ) Volume piscina (m <sup>3</sup> ) Templado: 16-24°C Warm 16-24°C Tempéré: 16-24°C Calore: 16-24°C Cálido: +25°C Hot: +25°C Chaud: +25°C Calore: +25°C	40  25	60  50	100  80
Detector flujo Flow detector Décteur flux Rilevatore di flusso	Detector gas Gas detector Décteur gaz Rilevatore di gas		
Rango de salinidad/Temperatura Salinity / Temperature range Niveau de salinité / Température Grado di salinitá / Range di temperatur	3 12 g./l. / +15 - 40°C		
Electrodos Electrodes Électrodes Elettrodi	Titanio con recubrimiento AUTO-LIMPIANTE, calidad ESTANDAR. Duración estimada: 3.000-5.000 horas (dependiendo de la calidad del agua)	SELF-CLEANING coated Titanium Estimated lifetime: 3.000-5.000 hours of operation (depending on water quality)	
	Titane avec recouvrement AUTO-NETTOYANTE. Temps de vie PRÉVU: 3.000-5.000 heures (suivant la qualité de l'eau)	Autopulenti rivestiti in titanio. Tempo di vita 3.000 - 3.500 H (dipende dalla qualità dell'acqua)	
Control producción Production control Contrôle production Controllo produzione	0 - 100 % (5 niveles de producción) 0 - 100 % (5 production levels) 0 - 100 % (5 niveaux de production) 0 - 100 % (5 livelli di produzione)		
Inversión polaridad Polarity switch Inversion polarité Inversione di polarità	Programmable: 2 <sup>(1)</sup> / 3 horas (jumper en plac de control) + modo test Programmable: 2 <sup>(1)</sup> / 3 hours (jumper in control board) + test mode Programmable: 2 <sup>(1)</sup> / 3 heures (jumper en plaque de contrôle) + mode test Programmabile : 2 <sup>(1)</sup> / 3 ore con quadro di controllo e test mode		
Protección nivel de sal Salt level protection Protection niveau de sel Protezione livello sale	Protección automática de producción Automatic protection of output current Protection automatique de production Protezione automatica di corrente in uscita		

<sup>(1)</sup> Configuración fábrica Factory default Réglages usine Impostazione di fabbrica

REF. AR2084 CBX PACK 2

8412081212753



### Clorador de piscina elevadas

Sistema que desinfecta el agua de la piscina convirtiendo por electrolisis el cloruro sódico (sal) en iones de cloro. Fácil instalación. Utilizar solo Cloruro sódico con pureza 99%.

### Chlorinateur pour des piscines hors sol

Système de désinfection de l'eau de la piscine par conversion au procédé d'électrolyse du chlorure de sodium (sel) en ions de chlore. Installation facile. Utilisable exclusivement avec du chlorure de sodium d'une pureté de 99%.

### Salt chlorinator for above-ground pools

This system disinfects pool water through the electrolysis. It transforms the sodium chloride (salt) into chlorine ions. Easy to install. Use only 99 % pure salt.

### Clorinatore per piscine fuori terra

Sistema che disinfecta l'acqua della piscina convertendo attraverso elettrolisi il cloruro di sodio (sale) in ioni cloruro. Facile installazione. Usare solo cloruro di sodio puro al 99%.

# complementos complements

REF. 90365

PB PACK 1

8427370903656

Sal compacta  
saco 25kg

Compact salt  
bag 25kg

Sel compacté  
sac 25kg

Sale compatto  
25kg



REF. CPH14

BXL PACK 1

8412081259000

El controlador de pH con bomba peristáltica para piscina enterrada automatiza la regulación del pH, lo que permite estabilizar el pH en el valor ideal para su confort y optimizar la eficacia del tratamiento de desinfección.

Le contrôleur de pH avec pompe péristaltique pour piscine enterrée automatise la régulation du pH, ce qui permet de stabiliser le pH sur la valeur idéale pour votre confort et optimiser l'efficacité du traitement de désinfection.

pH-Control dosing system is a peristaltic pump designed to maintain a chosen pH level on inground pools, allowing stabilize the pH in the ideal value for comfort and to optimize the efficiency of the disinfection treatment.

Il regolatore di pH con pompa peristaltica per piscine interrata automatizza la regolazione del pH consentendo di stabilizzarlo su un valore ideale e ottimizzando l'efficacia del trattamento di disinfezione.



REF. BDP4

BXL PACK 1

8412081250694

Bomba dosificadora peristáltica. Caudal variable 4 l/h y 1,5 Bar. Permite dosificar el producto químico de forma fácil y segura.

Pompe doseuse péristaltique. Vitesse variable 4l/h et 1,5 bar. Permet le dosage de produit chimique de façon facile et précise.

Peristaltic dosing pump. Variable flow rate. 4 l/h and 1,5 Bar. Safe and easy way of dosing of the chemical product UV-C.

Pompa per il dosaggio del prodotto chimico. Pressione variabile 4 l/h e 1,5 Bar



REF. UV015

CBX PACK 1

8412081250717

Equipo de desinfección UV para piscinas / spas hasta 15m<sup>3</sup>

Equipement de désinfection UV pour piscines et spas jusqu'à 15m<sup>3</sup>

UV-C Disinfection system for pools and spas up to 15m<sup>3</sup>

Kit disinfezione raggi UV per piscine fino a 15m<sup>3</sup>



REF. UV045

CBX PACK 1

8412081250700

Equipo de desinfección UV para piscinas / spas hasta a 50m<sup>3</sup>

Equipement de désinfection UV pour piscines et spas jusqu'à 50m<sup>3</sup>

UV-C Disinfection system for pools and spas up to 50m<sup>3</sup>

Kit disinfezione raggi UV per piscine fino a 50m<sup>3</sup>



**ILUMINACIÓN LIGHTING**  
**ÉCLAIRAGE ILLUMINAZIONE**



REF. LLEDP56W

CBX PACK 1

8412081257570

Lámpara LED BLANCA PAR56 de muy fácil instalación 100% fabricada en EU (fábrica propia). El proveedor del LED es Philips Lumileds que ofrecen una vida útil de 100.000h y un flujo del 70% transcurridas 60.000h. Importantes ahorros en energía respecto a una lámpara halógena: hasta un 92%. 3 años de garantía.

Ampoule LED BLANCHE PAR56 très facile à installer 100% fabriquée dans la CEE (usine propre). Le fournisseur de LED est Philips Lumileds. Les ampoules offrent une durée de vie de 100 000 h et un flux de 70% après 60.000h. Importantes économies d'énergie par rapport à une ampoule halogène: jusqu'à 92%. 3 ans de garantie.

Easily installed PAR56 WHITE LED lamp 100% manufactured in EU (own production). The LED is supplied by Philips Lumileds and has a useful life of 100,000 h and a 70% flow after 60,000 h. Important energy savings regarding a halogen lamp: up to 92%. 3 years guarantee.

Lampada PAR56 LED BIANCA PAR56 di semplicissima installazione, prodotta al 100% in EU (produzione propria). Il fornitore del LED è Philips Lumileds che offre una durata utile di 100.000 ore e un flusso del 70% dopo 60.000 ore. Ciò consente notevoli risparmi di energia rispetto a una lampada alogena: fino al 92% circa. 3 anni di garanzia.



REF. LLEDP56C

CBX PACK 1

8412081257587

Lámpara LED COLOR PAR56 de muy fácil instalación 100% fabricada en EU (fábrica propia). El proveedor del LED es Philips Lumileds que ofrecen una vida útil de 100.000h y un flujo del 70% transcurridas 60.000h. Importantes ahorros en energía respecto a una lámpara halógena: hasta un 88%. 12 colores y 8 secuencias. 3 años de garantía.

Ampoule LED COULEUR PAR56 très facile à installer 100% fabriquée dans la CEE (usine propre). Le fournisseur de LED est Philips Lumileds. Les ampoules offrent une durée de vie de 100 000 h et un flux de 70% après 60 000 h. Importantes économies d'énergie par rapport à une ampoule halogène: jusqu'à 88%. 12 couleurs et 8 séquences. 3 ans de garantie.

Easily installed PAR56 COLOUR LED lamp 100% manufactured in EU (own production). The LED is supplied by Philips Lumileds and has a useful life of 100,000 h and a 70% flow after 60,000 h. Important energy savings regarding a halogen lamp: up to 88% 12 colors and 8 sequences. 3 years guarantee.

Lampada LED COLOR PAR56 di semplicissima installazione, prodotta al 100% in EU (produzione propria). Il fornitore del LED è Philips Lumileds che offre una durata utile di 100.000 ore e un flusso del 70% dopo 60.000 ore. Ciò consente notevoli risparmi di energia rispetto a una lampada alogena: fino al 88% circa. 12 colori e 8 sequenze. 3 anni di garanzia.



REF. PLED1C

BL PACK 12

8412081257518

Proyector LED COLOR para piscina elevada de acero. Fácil instalación, se pega a la chapa mediante un imán. Incorpora mando a distancia para fácil manejo. Tecnología Led de bajo consumo.

Projecteur LED de COULEUR pour piscine hors sol. Ils sont spécialement conseillés pour les piscines hors sol en tôle. Se fixe simplement sur la tôle grâce à un aimant. Ils incorporent une télécommande très simple à utiliser. Technologie LED à faible consommation.

COLOR LED projector for above ground pools. Stick to the sheet with a magnet and ready to use. Includes remote control for easy operation. Energy-saving LED technology.

Faretto LED MULTICOLOR per piscina fuoriterra. Foglio adesivo con un magnete pronto all'uso. Include telecomando a distanza per un facile funzionamento. Risparmio energetico tecnologia al LED.

# complementos complements

REF. PLED2

CS PACK 4

8412081250830

Conjunto de 2 proyectores LED BLANCOS para piscina elevada de acero. Fácil instalación, se pega a la chapa mediante un imán. Incorpora mando a distancia para fácil manejo. Tecnología Led de bajo consumo.

Ensemble de 2 projecteurs LED pour piscine hors sol. Il est spécialement conseillé pour les piscines hors sol en tôle. Se fixe simplement sur la tôle grâce à un aimant. Il incorpore une télécommande très simple à utiliser. Technologie LED à faible consommation.

Set of 2 WHITE LED projectors for above ground pools. Stick to the sheet with a magnet and ready to use. Includes remote control for easy operation. Energy-saving LED technology.

2 Faretto LED per piscina fuoriterra. Foglio adesivo con un magnete pronto all'uso. Include telecomando a distanza per un facile funzionamento. Risparmio energetico tecnologia al LED.



REF. PLCH144

BL PACK 1

8412081250816

Proyector 144 LEDs COLOR (RGB) piscina enterrada de HORMIGÓN.

Projecteur de 144 LEDS de COULEUR pour piscine enterrée BÉTON.

Projector with 144 LEDs, colour RGB for CONCRETE pools.

Faretto Ø 28 x 7, 144 LED MULTICOLOR RGB, per piscine interrate in MURATURA

REF. PLCL144

BL PACK 1

8412081250823

Proyector 144 LEDs COLOR (RGB) piscina enterrada de LINER.

Projecteur de 144 LEDS de COULEUR pour piscine enterrée avec LINER.

Projector with 144 LEDs, colour RGB for LINER pools.

Faretto Ø 28 x 7, 144 LED MULTICOLOR RGB, per piscine interrate con LINER.



REF. PLBH144

BL PACK 1

8412081250793

Proyector 144 LEDs blanco piscina enterrada de HORMIGÓN.

Projecteur de 144 LEDS BLANCHES pour piscine enterrée BÉTON.

Projector with 144 white LEDs for CONCRETE pools

Faretto Ø 28 x 7, 144 LED color BIANCO, per piscine interrate in MURATURA.

REF. PLBL144

BL PACK 1

8412081250809

Proyector 144 LEDs BLANCO piscina enterrada de LINER.

Projecteur de 144 LEDS BLANCHES pour piscine enterrée LINER.

Projector with 144 WHITE LEDs for LINER in-ground pools.

Faretto Ø 28 x 7, 144 LED color BIANCO, per piscine interrate con LINER.



REF. 90173

CBX PACK 12

8427370901737

**Lámpara fantasía**

7 programas de luz diferentes.

**Lampe fantasie**

sept jeux de lumière sur les parois et le fond de la piscine.

**Fancy lamp**

7 different lighting programmes.

**Lampada fantasia**

ette giochi di luce differenti ai lati della piscina e sul fondo.



REF. 40710

BX PACK 12

8427370407109

Bombilla 300w para proyector.

Ampoule 300w pour projecteur.

300w bulb for underwater light.

Lampada 300w per faro.

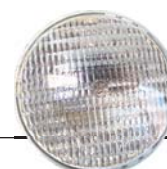



**NEW**

REF. LEDRW

CBX PACK 12

8412081257464

Proyector LED BLANCO de alto rendimiento para conectar a la válvula de retorno. Adaptable a piscinas elevadas tanto autoportantes como de pared rígida. Caudal mínimo necesario: 3.000 l/h. Funciona sin necesidad de batería.

WHITE LED projector for connecting to the return valve. Adaptable for movable above ground pools with rigid walls. High performance WHITE LEDs. Generates light at no cost, does not need batteries. Minimal flow needed: 3000 l/h

Projecteur LED BLANCHE à haut rendement pour connecter à la buse de refoulement. Adaptable à des piscines hors-sol, aussi bien autoportantes qu'avec des parois rigides. Débit minimum nécessaire : 3 000 l/h. Fonctionne sans nécessité de batterie.

Proiettore LED BIANCO a resa elevata per connessione alla valvola di ritorno. Si adatta a piscine fuori terra, sia autoportanti che a parete rigida. Flusso minimo necessario: 3.000 l/h. Funziona senza batteria.



**NEW**

REF. LEDRC

CBX PACK 12

8412081257471

Proyector LED COLOR de alto rendimiento para conectar a la válvula de retorno. Adaptable a piscinas elevadas tanto autoportantes como de pared rígida. Caudal mínimo necesario: 3.000 l/h. Funciona sin necesidad de batería.

COLOUR LED projector for connecting to the return valve. Adaptable for movable above ground pools with rigid walls. High performance COLOUR LEDs. Generates light at no cost, does not need batteries. Minimal flow needed: 3000 l/h

Projecteur LED COULEUR à haut rendement pour connecter à la buse de refoulement. Adaptable à des piscines hors-sol, aussi bien autoportantes qu'avec des parois rigides. Débit minimum nécessaire : 3 000 l/h. Fonctionne sans nécessité de batterie.

Proiettore LED COLOR a resa elevata per connessione alla valvola di ritorno. Si adatta a piscine fuori terra, sia autoportanti che a parete rigida. Flusso minimo necessario: 3.000 l/h. Funziona senza batteria.



REF. LED30

BXL PACK 2

Ø30cm x 31cm

8412081241715

Lámpara led redonda  
Batería recargable de litio, con mando a distancia, cambio de colores RGB, resistente al agua. 7 colores.

Round LED lamp  
Rechargeable lithium battery, remote-controlled, RGB color change, waterproof. 7 colors.

Lampe LED ronde  
Batterie au lithium rechargeable, télécommandé changement de couleur RGB, imperméable à l'eau. 7 couleurs.

Lampada rotonda LED  
Batteria ricaricabile al litio agli, telecomandato, cambiamento di colore RGB, impermeabile. 7 colori.



REF. LED21

BXL PACK 4

Ø17cm x 21cm

8412081241722

Lámpara led forma de gota  
Batería recargable de litio, con mando a distancia, cambio de colores RGB, resistente al agua. 7 colores.

LED lamp teardrop  
Rechargeable lithium battery, remote-controlled, RGB color change, waterproof. 7 colors.

Lampe LED larme  
Batterie au lithium rechargeable, télécommandé, changement de couleur RGB, imperméable à l'eau. 7 couleurs.

Lampada LED a goccia  
Batteria ricaricabile al litio agli, telecomandato, cambiamento di colore RGB, impermeabile. 7 colori.

## CALEFACCIÓN HEATING SYSTEMS CHAUFFAGE RISCALDAMENTO

### Bombas de calor

Sistema energético basado en el aprovechamiento de la energía exterior para calentar el agua de piscina, con relaciones de 1 kw consumido - 5 Kw aportados. Compresor Rotativo (Ref. AR2098 Compresor Scroll) con protección interna, batería evaporadora de alto rendimiento, ventilador axial con motor de acoplamiento directo, condensador de agua de Titanio Puro.

### Pompe à chaleur

Système énergétique basé sur l'utilisation de l'énergie extérieure pour chauffer l'eau de la piscine avec un rapport de 1 Kw consommé – 5 Kw restitués. Compresseur Rotatif (Ref. AR2098 Compresseur Scroll) avec protection interne, évaporateur à haut rendement, ventilateur axial avec moteur à accouplement direct et condenseur d'eau en Titane.

### Heat pumps

Heating system based on the use of the energy coming from the external air to heat pool water in the ratio of 1 Kw of energy consumption to 5 Kw of output. Rotary compressor (Ref. AR2098 Scroll compressor) with internal protection, high performance battery, axial fan with direct coupling motor and Titanium water capacitor.

### Pompe di calore

Sistema di riscaldamento basato sull'uso dell'energia proveniente dall'aria esterna per riscaldare l'acqua della piscina nel rapporto di 1 Kw di consumo di energia per 5 Kw di potenza. Comprensore rotante (Rif. AR2098 comprensore Scroll) con protezione interna, batteria ad alte prestazioni, ventilatore assiale con giunto diretto motore e condensatore acqua in titanio.



Art.-Nr. AR2098



Coefficiente energético  
Energy coefficient  
Coeff. énergétique  
Coefficiente di energia

Potencia  
Power  
Puissance  
Potenza



	max.	Water	Electricity	W	W	Coefficiente energético	Potencia	dB	Box	Barcode
AR2094	10.000 l	4.000 l/h	3.000 W	600 W	5	0,5 HP/CV	47 dB	BXL pack 1	224749	
AR2095	15.000 l	4.000 l/h	4.200 W	850 W	5	1 HP/CV	47 dB	BXL pack 1	220598	
AR2096	30.000 l	5.000 l/h	8.500 W	1.700 W	5	2 HP/CV	51 dB	BXL pack 1	220604	
AR2097	47.000 l	7.500 l/h	13.500 W	2.300 W	5	3 HP/CV	58 dB	BXL pack 1	220673	
AR2098	72.000 l	9.000 l/h	21.000 W	4.500 W	4,7	5 HP/CV	58 dB	BXL pack 1	227542	

Temperatura ambiental de 16°C, temperatura del agua 20°C y humedad del 70%. 16°C at room temperature, 20°C water temperature and 70% humidity.  
Une température de l'air extérieur de 16°C, une température d'eau de 20°C et un taux d'humidité de 70%. Temperatura aria di 16°C, 70% umidità e temperatura acqua a 20°C.

REF. AR20753 BXL PACK 1

8412081251806



### Intercambiador de calor

Sistema diseñado para calentamiento del agua de piscinas o spas. Recomendado principalmente para pequeños volúmenes de agua. Potencia 3 kw. Incorpora termostato, y gracias a su blindaje de titanio, apenas precisa mantenimiento

### Réchauffeur électrique

Système conçu pour le chauffage de l'eau des piscines ou spas. Recommandé principalement pour des petits volumes d'eau. Puissance 3 kw. Il intègre un thermostat, et grâce à son blindage en titane, il ne nécessite quasiment pas d'entretien.

### Electrical heat exchanger

System designed to heat pools or spas water. Recommended mainly for small volumes of water. Power output: 3 kw. Thermostat included. Little maintenance required due to its titanium shield.

### Scambiatore di calore

Sistema disegnato per il riscaldamento dell'acqua di piscina o centri benessere. Raccomandato principalmente per piccoli volumi d'acqua. Potenza 3 kw. Include termostato e, grazie alla sua armatura in titanio, non ha praticamente bisogno di manutenzione.

**CALEFACCIÓN SOLAR SOLAR HEATING SYSTEM  
CHAUFFAGE SOLAIRE RISCALDAMENTO SOLARE**



REF. AR2069    **CBX PACK 1**

8412081203331

Sistema para calentamiento del agua de la piscina mediante la acción Solar. Fabricado en polietileno. Aumenta la Temperatura del agua hasta 6°C. Mas de 12 kw/h de calor al día. 600x60 cm. Peso 7 kg. Potencia de la bomba mínima recomendada: 1/3 CV.

Chauffage solaire pour piscine. Fabriqué en polyéthylène. Il augmente la température de l'eau jusqu'à 6°C. 600x60 cm. Poids 7 kg. Puissance de la pompe minimale recommandée: 1/3 CV.

Solar pool water heating system. Made of polythene. Water temperature can be increased up to 6 °C. 600x60 cm. Wight: 7 kg. Minimum recommended pump output: 1/3 hp.

Sistema per il riscaldamento dell'acqua della piscina per mezzo dell'azione del sole. In polietilene. Aumenta la temperatura dell'acqua fino a 6°C. 600x60 cm. Peso 7 kg. Potenza minima della pompa raccomandata: 1/3 CV.



REF. AR20693    **CBX PACK 1**

8412081241449

Calentador solar de agua para piscinas autoportantes. Fabricado con materiales flexibles (nylon y pvc). Medidas: 130x80 cm. Peso 1,2 kg. Aumenta la Temperatura del agua hasta 4°C. Funciona con bomba de piscina desde 4m³/h.

Rechauffeur solaire pour piscines autoportantes. Fabriqué avec des matériaux souples (nylon et pvc). Dimensions: 130x80cm. Poids 1,2 kg. Augmente la temperature de l'eau jusqu'a 4°C. Puissance de la pompe minimum recommandée: 4m³/h.

Solar pool water heating system for inflatable pools. Made of flexible materials (nylon and pvc). Dimensions: 130x80 cm. Weight: 1,2 kg. Water temperature can be increased up to 4°C. Minimum water volume: 4m³/h.

Sistema di riscaldamento solare di acqua per piscine autoportanti. Fabricato con materiali flessibili (nylon e pvc). Misure: 130x80 cm. Peso 1,2 kg. Aumenta la temperatura dell'acqua fino a 4°C. Funziona con pompe da piscina da 4m³/h.



REF. 90230    **CBX PACK 1**

8427370902307

Calentador solar. Permite aumentar la temperatura de su piscina por la acción del sol. Los calentadores pueden conectarse entre sí en serie. Aumenta la temperatura del agua 3°C en piscinas entre 7,5m³ y 10m³.

Chauffage solaire pour piscine. Système pour le chauffage solaire de l'eau de la piscine. Les réchauffeurs peuvent se connecter entre eux en série. Augmente la température de 3°C max. pour les piscines entre 7,5m3 et 10m3.

Solar heating. Solar pool water heating system. The heaters should be connected in series to heat the pool.

Riscaldatore solare. Permette di aumentare la temperatura della sua piscina tramite l'azione dei raggi solari.



REF. AR2000    **BXL PACK 1**

8412081221571

Kit Bypass

Contiene: 3 Válvulas apertura/cierre + 2 mangueras Ø38 mm x 1,5 m + 6 piezas de reducción Ø38 - 50 mm para encolar + 4 abrazaderas

Kit Bypass

Comprend: 3 vannes ouverture / fermeture + 2 tuyaux Ø38 cm x 1,5 m + 6 pièces réduction Ø38 - 50 mm à coller + 4 colliers



Bypass kit

Contains: 3 opening/closing valves + 2 hoses Ø38 mm x 1,5 m + 6 reduction parts Ø38 - 50 mm to glue + 4 lamps

Kit Bypass

Contiene: 3 valvole di apertura/chiusura + 2 tubi flessibili Ø38 cm x 1,5 m + 6 pezzi adattatori Ø38 - 50 mm da incollare + 4 fascette

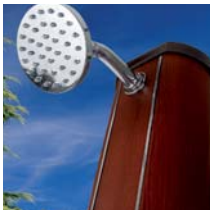
## DUCHAS SHOWERS DOUCHES DOCCIA

**REF. DSALR32W BXL PACK 1**  **8412081238135**

Ducha solar redonda 32l Aluminio aspecto madera Con grifo lavapies	Round solar shower 32l Aluminium Woodlike With footwash tap
Douche solaire ronde 32l Aluminium Aspect bois Avec robinet lave pieds	Doccia solare round 32l Alluminio Imitazione legno Rubinetto lavapiedi





**REF. DSALC32W BXL PACK 1**  **8412081238142**

Ducha solar cuadrada 32l Aluminio Aspecto madera Con grifo lavapies	Square solar shower 32l Aluminium Woodlike With footwash tap
Douche solaire carrée 32l Aluminium Aspect bois Avec robinet lave pieds	Doccia solare square 32l Alluminio Imitazione legno Rubinetto lavapiedi



**REF. AR1130 BXL PACK 1**  **8412081224510**

Ducha solar de jardín 32l Aluminio Con nebulizador y grifo lavapies	Round solar shower 32l Aluminium Woodlike With footwash tap
Douche solaire 32 litres avec brumisateur et lave-pieds Aluminium	Doccia solare 32l Alluminio Nebulizzatore e rubinetto lavapiedi



**REF. AR1035 BXL PACK 1**  **8412081230931**

Ducha solar 38l - PVC Douche solaire de jardin 38l - PVC	Garden solar shower 38l - PVC Doccia solare 38l - PVC
--	---





REF. AR1030 BXL PACK 1  8412081220765

Ducha solar 30l - PVC Garden solar shower 30l - PVC  
 Douche solaire de jardin 30l - PVC Doccia solare 30l - PVC



REF. AR10250 BXL PACK 1  8412081224497

Ducha solar 20l - PVC Garden solar shower 20l - PVC  
 Douche solaire de jardin 20l - PVC Doccia solare 20l - PVC

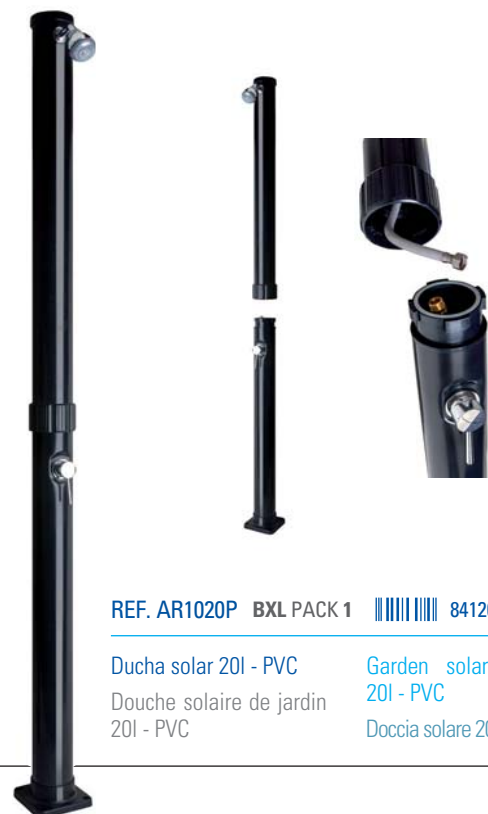

REF. AR1020P BXL PACK 1  8412081240817

Ducha solar 20l - PVC Garden solar shower 20l - PVC  
 Douche solaire de jardin 20l - PVC Doccia solare 20l - PVC



REF. 40664 BXL PACK 1  8427370406645

Ducha solar 20l - PVC Color NEGRO Garden solar shower 20l - PVC BLACK color  
 Douche solaire de jardin 20l - PVC Couleur: NOIR Doccia solare 20l - PVC Colore: NERO

REF. DS20C BXL PACK 1  8412081250854

Ducha solar 20l - PVC Color ROJO Garden solar shower 20l - PVC RED color  
 Douche solaire de jardin 20l - PVC Couleur: ROUGE Doccia solare 20l - PVC Colore: RED

# complementos complements

REF. AR104

CBX PACK 12

8412081950716

Ducha alluminio. Fácil instalación y conexión.

Douche en aluminium. Montage et raccordement facile

Aluminium shower. Easy installation and connection.

Doccia alluminio. Facilità di installazione e collegamento.



REF. DPE10

CBX PACK 12

8412081257501

Ducha para piscina sobre suelo. Con sistema de fijación al pasamanos de la escalera.

Douche pour piscine hors sol. Système de fixation à mâchoire universelle pour échelle tubulaire ou autres supports

Above-ground pool shower. With stair railings fixing system. No tools required.

Doccia per piscine fuori terra. Con sistema di fissaggio al corrimano della scaletta.



REF. SP7212

CBX PACK 1

8412081257556

Ducha-base de jardín automática. Se activa con el peso, al subirse a la base comienza a salir agua. Se conecta a una manguera de jardín.

Douche base de jardin automatique. Il suffit de marcher dessus pour se doucher. Activation par la charge de poids. Connexion pour le tuyau d'arrosage.

Automatic garden Shower-base automatic garden. Weight activated, just climb on and start showering. Connection for a garden hose.

Basta saltarci sopra e la doccia si attiva. Attivazione al rilevamento del peso. Attacco al tubo flessibile da giardino



# compléments **complementi**



REF. SSB96 **BXL PACK 1**

8412081250861

Base para ducha solar 90x60cm. Marco de aluminio, y lamas imitación madera

Solar shower base 90x60cm Aluminum frame and a wood aspect slat.

Socle pour douche solaire 90x60cm. Cadre en aluminium et lattes aspect bois

Base per doccia solare 90x60cm Bordo in alluminio, listelli imitazione legno

**NEW**

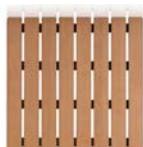

REF. SSB40 **BXL PACK 1**

8412081257563

Base para ducha solar 60x60cm. Lamas imitación madera

Solar shower base 60x60cm Wood aspect slat.

Socle pour douche solaire 60x60cm. Lattes aspect bois

Base per doccia solare 60x60cm Listelli imitazione legno



REF. LP01

**BX PACK 24**

8412081237695

Lavapiés

Footwash

Pédiluve

Lavapiedi

## REPUESTOS SPARE PARTS PIÈCES DE RECHANGE PARTI



REF. AR500  
CS PACK 6  8412081206462

Cesto para skimmer  
Skimmer Basket  
Panier pour skimmer  
Cesto prefiltro  
Ø ext. 16,2 cm ↑5,5 cm Ø int. 11 cm



REF. AR501  
CS PACK 12  8412081206486

Compuerta para skimmer  
Weir for skimmer  
Volet pour skimmer  
Sportellino  
12 x 14,5 x 2 cm



REF. AR502  
CS PACK 12  8412081206493

Giunto doppio di stagno  
Skimmer layer  
Joint pour skimmer  
Giunto doppio di stagno  
ext. 20,5 x 19,5 x 0,5 cm  
int. 14,8 x 13,9 x 0,5 cm



REF. AR521  
CS PACK 12  8412081250748

Junto doble skimmer + 2 juntas de  
válvula de retorno  
Double seal for skimmer + 2 seals for  
return valve  
Joint double skimmer + 2 joints  
pour buse de refoulement  
Guarnizione doppia standard Skimmer +  
2 guarnizioni per la valvola di ritorno



REF. AR503  
CS PACK 6  8412081206509

Boquilla de impulsión  
Return fitting  
Buse de refoulement  
Valvola di impulsione completa



REF. AR505  
CS PACK 8  8412081208619

Tapa para conexión de manguera  
limpiafondos  
Lid for connecting the vacuum  
hose to the skimmer  
Couvercle pour relier le tuyau  
flottant au skimmer  
Adattatore per puliscifondo



REF. AR506  
CS PACK 8  8412081208602

Manómetro  
Pressure gauge  
Manomètre  
Manometro



REF. AR512  
CS PACK 12  8412081221601

Válvula apertura/cierre Ø38-Ø32  
Open/close valve Ø38-Ø32  
Vanne ouverture/fermeture Ø38-Ø32  
Valvola di apertura/chisura Ø38-Ø32

# compléments **complementi**



**REF. AR508**  
**CS PACK 11** ||| 8412081208589

Zuncho universal  
Filter ring  
Collier de fixation  
Ghiera filtro



**REF. AR510**  
**CS PACK 24** ||| 8412081215785

Cintaflón y 4 abrazaderas  
Cintaflon and 4 clamps  
Teflon et 4 colliers  
Nastro Teflon e 4 fascette



**REF. Y12**  
**CS PACK 50** ||| 8412081940861

2 filtros para limpiafondos ventury  
2 filters for ventury bottom cleaner  
2 filtres pour aspirateur de fond  
2 filtri per puliscifondo venturi



**REF. 40045**  
**CS PACK 30** ||| 8427370400452

10 filtros de skimmer  
10 filter savers  
10 filtres pour skimmer  
10 filtri di skimmer



**REF. 40080**  
**BL PACK 24 DIS** ||| 8427370400803

Kit reparación liner  
Liner repair kit  
Kit réparation liner  
Kit riparazione liner



**REF. V12**  
**BL PACK 50** ||| 8412081870236

Kit reparador de PVC  
PVC repair kit  
Kit réparation PVC  
Kit per riparazioni PVC



**REF. AR202**  
**BL PACK 96** ||| 8412081960203

Film reparador de PVC  
PVC repair film  
Film réparation PVC  
Pellicola per riparare i liner



## Leyenda Legend Légende Legenda

### **BX**

caja  
box  
box  
scatola

### **BXL**

caja con etiqueta  
box and label  
carton avec étiquette  
scatola con etichetta

### **CB**

cartoncillo  
cardboard wrap  
bande carton  
cartone

### **CBX**

caja litografiada  
colour box  
boîte de couleur  
scatola serigrafata

### **PB**

bolsa de plástico  
polybag  
sac plastique  
busta di plastica

### **PBH**

bolsa de plástico con cartoncillo  
polybag with header  
sac plastique avec bande carton  
sacchetto di plastica con cartone

### **BL**

blistér  
blister  
blister  
blister

### **CS**

doble burbuja  
clamshell  
double coque  
doppio rivestimento

### **DIS**

display  
display  
display  
display



manguera  
hose  
tuyau  
tubo



cable  
wire  
câble  
cavo

# material de cleaning limpieza material

MATERIAL DE LIMPIEZA	92	CLEANING MATERIAL
Robots	94	Robots
Limpiafondos automáticos	98	Automatic cleaners
Limpiafondos de aspiración	100	Vacuum cleaners
Kits limpiafondos	101	Vacuum cleaners kits
Limpiafondos Ventury	102	Ventury vaccum
Gama Superluxe	103	Superluxe range
Limpiafondos manuales	104	Vacuum heads
Cepillos	105	Brushes
Dosificadores	106	Dispensers
Termómetros	106	Thermometers
Mangos telescópicos	107	Telescopic handles
Recogehojas	108	Leaf nets and rakes
Mangeras flotantes	109	Vacuum hoses
Racordería	112	Fittings
Protección invierno	113	Winter protection

# matériel de cleaning nettoyage material

MATÉRIEL DE NETTOYAGE	92	MATERIALE DI PULIZIA
Robots	94	Robots
Nettoyeurs automatiques	98	Puliscifondi automatici
Nettoyeurs pour aspiration	100	Pulitore fondo ad aspirazione
Kit nettoyeurs	101	Kit Pulitore fondo
Aspirateurs de fond ventury	102	Puliscifondi Ventury
Gamme Superluxe	103	Gamma Superluxe
Balais manuels	104	Puliscifondo manuale
Brosses	105	Spazzole
Doseurs	106	Dosatori
Thermomètres	106	Termometri
Manches télescopiques	107	Manico telescopico
Épuisettes	108	Raccoglitori
Tuyaux flottants	109	Tubi galleggianti
Raccords PVC	112	Raccorderia in PVC
Protection hiver	113	Protezione inverno

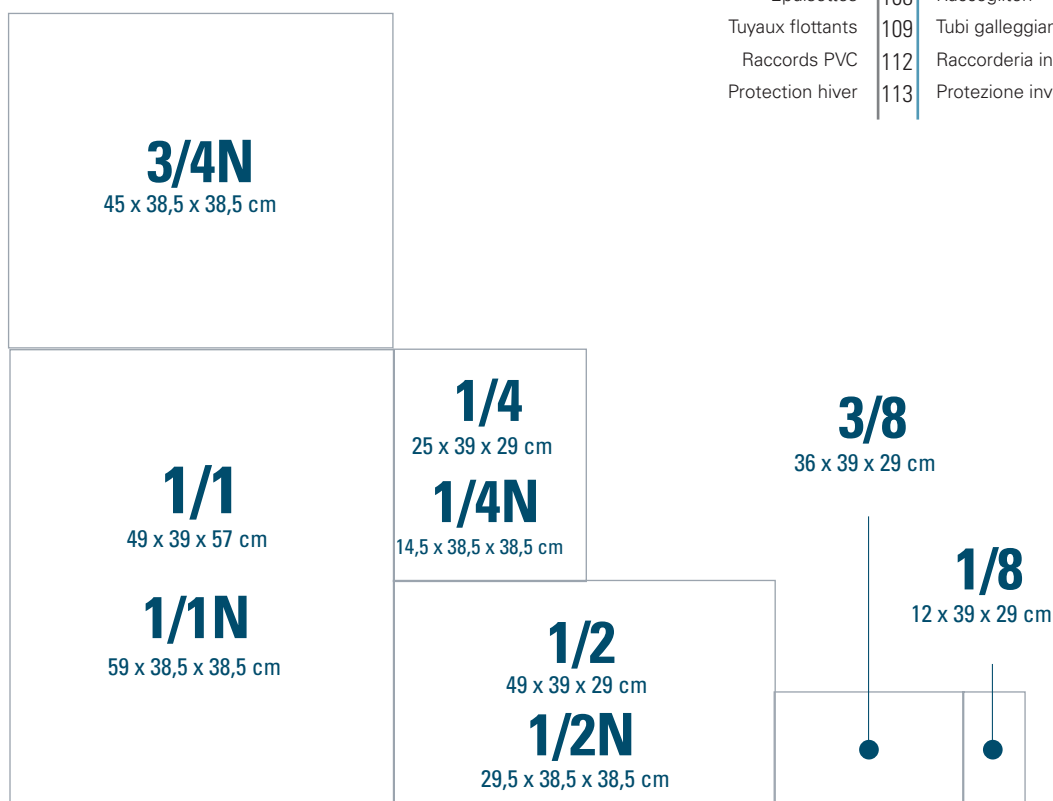

# material de limpieza

# cleaning material

## ROBOTS ROBOTS ROBOTS ROBOTS

### KAYAK FUTURE REMOTE CONTROL

REF. RKFA100CR

18 m

CBX PACK 1

8412081253312

El Kayak Future CR se adapta a todo tipo de piscinas hasta 120m<sup>2</sup> de superficie y limpia el fondo, las paredes y la línea de agua de su piscina.

Le robot Kayak Future RC convient pour tout type de piscine d'une superficie jusqu'à 120 m<sup>2</sup>. Il nettoie le fond, les parois ainsi que la ligne d'eau.

The Kayak Future CR adapts to all types of pools measuring up to 120m<sup>2</sup> in surface area, cleaning the bottom, walls and water line.

Il Robot Kayak Future CR si adatta a tutti i tipi di piscine fino a 120m<sup>2</sup> di superficie, pulendo il fondo, le pareti e linea dell'acqua.

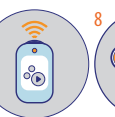
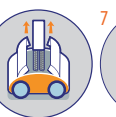
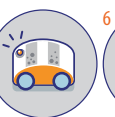
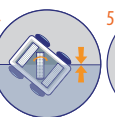
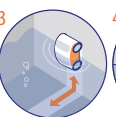

### KAYAK FUTURE

REF. RKFA100

18 m

CBX PACK 1

8412081250847

El Kayak Future se adapta a todo tipo de piscinas hasta 120m<sup>2</sup> de superficie y limpia el fondo, las paredes y la línea de agua de su piscina.

Le robot Kayak Future convient pour tout type de piscine d'une superficie jusqu'à 120 m<sup>2</sup>. Il nettoie le fond, les parois ainsi que la ligne d'eau.

The Kayak Future adapts to all types of pools measuring up to 120m<sup>2</sup> in surface area, cleaning the bottom, walls and water line.

Il Robot Kayak Future si adatta a tutti i tipi di piscine fino a 120m<sup>2</sup> di superficie, pulendo il fondo, le pareti e linea dell'acqua.

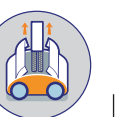
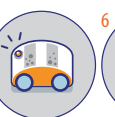
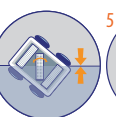
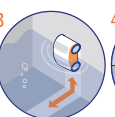

- GYRO:** Nuevo Sistema de Navegación Giroscópica que maximiza el ciclo de lavado y evita que el cable se enrede **New Gyroscopic Navigation System to improve navigation of the robot, maximize efficacy and prevent cable tangling** Nouveau système de navigation qui maximise le cycle de lavage et empêche cable enchevêtrement Nuovo sistema di navigazione che massimizza il ciclo di lavaggio e previene l'aggrovigliamento del cavo
- Aquasmart System:** Algoritmo patentado para limpiar la piscina en menos tiempo **Patented algorithm for covering a pool with less time** La fonction Aquasmart est un algorithme permettant un nettoyage plus rapide et plus efficace Algoritmo certificato per pulire una piscina in minor tempo
- Floor & Walls:** Limpia el suelo y las paredes de la piscina **Cleans the bottom and walls** Nettoie le fond et les parois de la piscine Pulisce fondo e pareti della piscina
- Water line:** Limpia la línea de flotación **Cleans the water line** Nettoie de la ligne d'eau Pulisce la linea dell'acqua
- Filter check:** Indicador de filtro lleno mediante LED **Full filter LED indicator** Indicateur LED dans le transformateur indiquant que le filtre est plein Indicatore filtro pieno mediante un LED luminoso
- Top access:** Filtro de acceso superior **Top access filter** Filtre facile à nettoyer avec le système top access Accesso al filtro nella parte superiore del robot
- Remote Control:** Con mando a distancia **With easy remote control** Télécommande de contrôle Telecomando a distanza
- Timer:** Ciclo de limpieza programable **Programmable cleaning cycle** Cycle de nettoyage programmable Ciclo di pulizia programmabile



# matériel de nettoyage materiale di pulizia

## TRACK SALT 4x4

REF. R44SC

18 m

CBX PACK 1

8412081252247

El Track Salt 4x4 se adapta a todo tipo de piscinas hasta 90m<sup>2</sup> de superficie y limpia el fondo, las paredes y la línea de agua de su piscina. Con clorador salino incorporado.

Le robot Track Salt 4x4 convient pour tout type de piscine d'une superficie jusqu'à 90 m<sup>2</sup>. Il nettoie le fond, les parois ainsi que la ligne d'eau. Avec un système d'électrolyse incorporé

The Track Salt 4x4 adapts to all types of pools measuring up to 90m<sup>2</sup> in surface area, cleaning the bottom, walls and water line. With chlorine generator.

Il Robot Tracks Salt 4x4 si adatta a tutti i tipi di piscine fino a 90m<sup>2</sup> di superficie, pulendo il fondo, le pareti e linea dell'acqua. Dotato di clorinatore salino incorporato.



## TRACK 4x4

REF. R44SP

18 m

CBX PACK 1

8412081252230

El Track 4x4 se adapta a todo tipo de piscinas hasta 90m<sup>2</sup> de superficie y limpia el fondo, las paredes y la línea de agua de su piscina.

Le robot Track 4x4 convient pour tout type de piscine d'une superficie jusqu'à 90 m<sup>2</sup>. Il nettoie le fond, les parois ainsi que la ligne d'eau.

The Track 4x4 adapts to all types of pools measuring up to 90m<sup>2</sup> in surface area, cleaning the bottom, walls and water line.

Il Robot Tracks 4x4 si adatta a tutti i tipi di piscine fino a 90m<sup>2</sup> di superficie, pulendo il fondo, le pareti e linea dell'acqua.



1. **GYRO:** Nuevo Sistema de Navegación Giroscópica que maximiza el ciclo de lavado y evita que el cable se enrede **New Gyroscopic Navigation System to improve navigation of the robot, maximize efficacy and prevent cable tangling** Nouveau système de navigation qui maximise le cycle de lavage et empêche câble enchevêtrement Nuovo sistema di navigazione che massimizza il ciclo di lavaggio e previene l'aggrovigliamento del cavo
2. **Floor & Walls:** Limpia el suelo y las paredes de la piscina **Cleans the floor and the wall of the pool** Nettoie le fond et les parois de la piscine Pulisce fondo e pareti della piscina
3. **Top access:** Filtro de acceso superior **Top access filter** Filtre facile à nettoyer avec le système top access **Acceso al filtro** nella parte superiore del robot
4. **Max scrubber:** Cepillo rotativo de gran velocidad **Fast moving brush** Brosse rotative de grande vitesse **Spazzola rotante** di grande velocità
5. **Easy view:** Ventana transparente para ver el filtro **Transparent window for seeing inside the filters** Système easy view pour avoir un aperçu sur le niveau de remplissage du filtre **Finestrella** trasparente per controllare meglio la situazione del filtro
6. **4x4:** Tecnología 4x4 patentada con un sólo motor de tracción **4x4 patented technology with only one drive motor** Système de traction 4x4 breveté avec 1 seul moteur pour une longévité accrue **Tecnología 4x4** brevettata con un solo motore di trazione
7. **Plug&Play:** Conectar y listo para usar **Put the robot in the water and it's ready to clean** Prêt à fonctionner **Una volta collegato è pronto per lavorare**
8. **Easy clean:** Filtro fácil y rápido de limpiar **Filter that enables quick and easy cleaning** Facilité d'accès pour nettoyer le robot **Filtro facile e rapido da pulire**
9. **Light:** Robot ligero **Light robot** Robot léger **Leggero**
10. **Filter check:** Indicador de filtro lleno mediante LED **Full filter LED indicator** Indicateur LED dans le transformateur indiquant que le filtre est plein **Indicatore filtro pieno** mediante un LED luminoso
11. **Cl<sub>2</sub>:** Con generador automático de cloro mediante sal **With automatic chlorine generator by salt** Avec générateur automatique du chlore avec le sel **Genera automaticamente** cloro mediante il sale

# material de limpieza

# cleaning material

## KAYAK ADVENTURE MAX

REF. RKM80CR

18 m

CBX PACK 1

8412081252261

El Kayak Adventure Max se adapta a todo tipo de piscinas hasta 100m<sup>2</sup> de superficie y limpia el fondo, las paredes y la línea de agua de su piscina.

Le robot Kayak Adventure Max convient pour tout type de piscine d'une superficie jusqu'à 100m<sup>2</sup>. Il nettoie le fond, les parois ainsi que la ligne d'eau.

The Kayak Adventure Max adapts to all types of pools measuring up to 100m<sup>2</sup> in surface area, cleaning the bottom, walls and water line.

Il Robot Kayak Adventure Max si adatta a tutti i tipi di piscine fino a 100m<sup>2</sup> di superficie, pulendo il fondo, le pareti e linea dell'acqua.

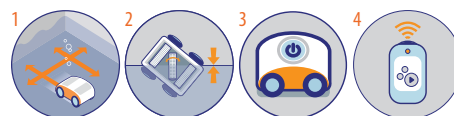

## KAYAK ADVENTURE

REF. RKA80

18 m

CBX PACK 1

8412081252254

El Kayak Adventure se adapta a todo tipo de piscinas hasta 100m<sup>2</sup> de superficie y limpia el fondo, las paredes y la línea de agua de su piscina.

Le robot Kayak Adventure convient pour tout type de piscine d'une superficie jusqu'à 100m<sup>2</sup>. Il nettoie le fond, les parois ainsi que la ligne d'eau.

The Kayak Adventure adapts to all types of pools measuring up to 100m<sup>2</sup> in surface area, cleaning the bottom, walls and water line.

Il Robot Kayak Adventure si adatta a tutti i tipi di piscine fino a 100m<sup>2</sup> di superficie, pulendo il fondo, le pareti e linea dell'acqua.

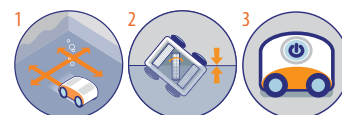

- 1. Floor & Walls:** Limpia el suelo y las paredes de la piscina Cleans the bottom and walls Nettoie le fond et les parois de la piscine Pulisce fondo e pareti della piscina
- 2. Water line:** Limpia la línea de flotación Cleans the water line Nettoyage de la ligne d'eau Pulisce la linea dell'acqua
- 3. Plug&Play:** Conectar y listo para usar Put the robot in the water and it's ready to clean Prêt à fonctionner Una volta collegato è pronto per lavorare
- 4. Remote Control:** Con mando a distancia With easy remote control Télécommande de contrôle Telecomando a distanza

# matériel de nettoyage materiale di pulizia

## KAYAK CLEVER

REF. RK100CJ

12 m

CBX PACK 1

8412081241753

El Kayak Clever limpia el fondo fondo inclinado o plano de piscinas hasta 60m<sup>2</sup> de superficie.

Le robot Kayak Clever RKC100J convient pour tout type de piscine à fond plat ou pente douce d'une superficie jusqu'à 60m<sup>2</sup>.

The Kayak Clever adapts to all types of pools measuring up to 60m<sup>2</sup> in surface area, cleaning the bottoms whether they are flat or inclined.

Il Robot Kayak Clever RKC100J si adatta a tutti i tipi di piscine fino a 60m<sup>2</sup> di superficie, pulendo il fondo in piano che inclinato.



## KAYAK JET BLUE

REF. RKJ14

12 m

CBX PACK 1

8412081252223

El Kayak Jet Blue limpia el fondo fondo inclinado o plano de piscinas hasta 60m<sup>2</sup> de superficie.

Le robot Kayak Jet Blue convient pour tout type de piscine à fond plat ou pente douce d'une superficie jusqu'à 60m<sup>2</sup>.

The Kayak Jet Blue adapts to all types of pools measuring up to 60m<sup>2</sup> in surface area, cleaning the bottoms whether they are flat or inclined.

Il Robot Kayak Jet Blue si adatta a tutti i tipi di piscine fino a 60m<sup>2</sup> di superficie, pulendo il fondo in piano che inclinato.



**1. Plug&Play:** Conectar y listo para usar Put the robot in the water and it's ready to clean Prêt à fonctionner Una volta collegato è pronto per lavorare

**2. Light:** Robot ligero Light robot Robot léger Leggero

**3. Top access:** Filtro de acceso superior Top access filter Filtre facile à nettoyer avec le système top access Accesso al filtro nella parte superiore del robot

## RECAMBIOS BOLSA FILTRANTE SPARE FILTRATION BAGS RECHARGES SAC POUR ROBOTS RICAMBI SACCO FILTRO



Recambio de bolsa filtrante textil - reutilizable - lavable

Recharge sac textile pour Robot Kayak - Réutilisable - Lavable

Spare filtration bag - 1 unit. Reusable - Washable

Busta per Robot Kayak - textil - scatola di 1 unità. Riutilizzabile - Lavabile

REF. 40683

PB pack 2

8427370406836



Sac jetable pour robot - carton de 3 pièces  
Sac jetable pour robot - carton de 3 pièces

Non-returnable spare filtration bag - 3 units  
Busta per robot usa e getta - scatola di 3 unità

REF. 40684

CBX pack 8

8427370406843

material de limpieza

cleaning material

## LIMPIAFONDOS AUTOMÁTICOS AUTOMATIC CLEANERS NETTOYEURS AUTOMATIQUES PULISCIFONDI AUTOMATICI

### PROFESSIONAL VAC

REF. 19007

□ 9,6m - Ø 38

CBX PACK 1



8427370190070

Limpiafondos automático de membrana. Limpia el fondo y las paredes de cualquier piscina. Funciona con sistemas de filtración de una potencia mínima de 0,2CV.

Nettoyeur automatique avec système unique de membrane. Nettoie le fond et les parois de la piscine. Il fonctionne avec des systèmes de filtration d'une puissance minimum de 0,2cv.

Automatic pool cleaner with membrane system. The Professional Vac cleans the bottom and walls of your pool. Works with 0,2 hp minimum.

Puliscifondo automatico con sistema a membrana. Il Professional Vac pulisce il fondo e le pareti della piscina. Funziona con sistemi di filtrazione che hanno una potenza minima di 0,2cv.



### SILENCE VAC

REF. 90397

□ 9,6m - Ø 38

CBX PACK 2



8427370903977

Limpiafondos automático más silencioso que los sistemas tradicionales de "martillo". Limpia el fondo y las paredes de su piscina. Funciona con sistemas de filtración de una potencia mínima de ½cv y máxima de 1½cv.

Nettoyeur automatique plus silencieux que les systèmes traditionnels à "marteau". Nettoie le fond et les parois de la piscine. Il fonctionne avec des systèmes de filtration d'une puissance minimum de ½cv et maximale de 1½cv.

Automatic pool cleaner which is quieter than the traditional "hammer" systems. The Silence Vac cleans the bottom and walls of your pool. Works with ½ hp minimum and 1½hp maximum power filtration systems.

Puliscifondo automatico più silenzioso dei sistemi tradizionali a "martello". Il Silence Vac pulisce il fondo e le pareti della piscina. Funziona con sistemi di filtrazione che hanno una potenza minima di ½cv e massima di 1½cv.



# matériel de nettoyage materiale di pulizia



## CLASSIC VAC

REF. 19001

8m - Ø 38

CBX PACK 1



8427370190018

Limpiafondos automático para piscinas enterradas y elevadas dotadas de un equipo de filtración con una bomba de una potencia mínima de 3/4 cv.

Automatic pool cleaner for in ground and above ground pools equipped with filtering equipment with a minimum power pump of 3/4 hp.

Nettoyeur automatique de piscines enterrées et hors-sol équipé d'une filtration avec une pompe d'une puissance minimum de 3/4cv.

Puliscifondo automatico per piscine interrattate e fuori terra dotate di un sistema di filtrazione con una potenza minima di 3/4 cv.



## WIKI VAC

REF. 90399

6m - Ø 32

CBX PACK 2



8427370903991

Limpiafondos automático para piscinas autoportantes y elevadas. Funciona con equipos de filtración de baja potencia: a partir de 0,1cv. Dispone de un prefiltro exclusivo que permite proteger el cartucho y la filtración aumentando así la vida de los equipos.

The automatic pool cleaner for inflatable or above ground pools. Works with low-power filtering equipment: ranging from 0.1hp. It has a unique pre-filter which protects the cartridge and filtration and in this way increasing the operating life of the equipment.

Nettoyeur automatique pour piscines autoportantes et hors-sol. Il fonctionne avec des filtrations de très faible puissance: à partir de 0,1cv minimum. Il dispose d'un préfiltre exclusif qui protège la cartouche et la filtration, augmentant ainsi leur durée de vie.

Puliscifondo per piscine autoportanti e fuoriterra. Funziona con un sistema di filtrazione a partire da 0,1 cv di potenza. E' dotato di un prefiltro esclusivo che permette una maggior cura della cartuccia e della filtrazione, migliorandone l'efficienza.

# material de limpieza

# cleaning material

## SMALL CONFORT

REF. AR20682

6m - Ø 32

CBX PACK 4

8412081232287



Limpiafondos automático por aspiración. Se conecta directamente al skimmer y es compatible con bombas a partir de 1/3CV.

Nettoyeur de fond automatique par aspiration. Il se branche directement sur le skimmer et il est compatible avec des pompes à partir de 1/3 de CV.

Automatic suction pool cleaner that is directly connected to the skimmer. Compatible with pumps from 1/3HP.

Puliscifondo automatico ad aspirazione. Si collega direttamente allo skimmer ed è compatibile con pompe a partire da 1/3CV.



## LIMPIAFONDOS DE ASPIRACIÓN MANUAL VACUUM CLEANERS NETTOYEURS ASPIRANTS PULITORE AD ASPIRAZIONE MANUALE

### MEDIUM VAC

REF. AR20637

9m - Ø 32

CBX PACK 6

8412081231099



Kit de mantenimiento para piscinas autoportantes o elevadas. Contiene dos boquillas (una de ellas con cepillo).

Le Kit d'entretien pour piscines autoportantes ou hors-sol. Contient: un aspirateur de fond à aspiration manuelle qui inclut deux embouts.

Maintenance kit for inflatable or above ground pools. The pool cleaner includes: two suction nozzles, one with a brush.

Kit di mantenimento per piscine autoportanti o fuori terra. Contiene due aspiratori, uno con pennello.



### LITTLE VAC

REF. 08011

5m - Ø 32

CBX PACK 6

8427370080111



Kit de mantenimiento para piscinas autoportantes o elevadas.

Le Kit d'entretien pour piscines autoportantes ou hors-sol.

Maintenance kit for inflatable or above ground pools.

Kit di mantenimento per piscine autoportanti o fuori terra.



## KITS LIMPIAFONDOS VACUUM CLEANER KITS KIT NETTOYEUR ASPIRANTS KIT PULITORE FONDO AD ASPIRAZIONE



REF. AR20641

CBX PACK 2

8412081224718

Limpiafondos para pértiga + pértiga 3 secciones + recogedor de fondo + termómetro flotante + dosificador oval + cepillo para liner + manguera 6m + bote de tiras reactivas (tester)

Bottom cleaner for pole + 3 section pole + leaf skimmer of bottom + floating thermometer + oval dispenser + brush for liner + 6m hose + can of reactive test strips (tester)

Pack d'entretien comprenant: un nettoyeur de fond pour manche + perche 3 sections + epuisette de fond + thermomètre flottant + doseur ovale pour galets de 200gr + brosse pour liner + 6m tuyau + boîte de bandelettes de test (tester)

Puliscifondi + pertica 3 sezioni + raccogliatore di fondo + termometro galleggiante + dosatore ovale + spazzola per liner + 6m tubo + confezione da striscie reattive (tester)



REF. AR2064

CBX PACK 4

8412081202433

Kit limpiafondos + pértiga 3,60m (3x1,20m) + manguera 6m

Vacuum head kit + handle 3,60m (3x1,20m) + 6m hose

Kit nettoyeur + manche 3,60m (3x1,20m) + tuyau 6m

Kit puliscifondo + pertica 3,60m (3x1,20m) + tubo 6m



REF. KMA05

CS PACK 6

8412081237664

Kit mantenimiento piscinas: analizador pH/Cl, cepillo 45 cm, recogehojas supercie, termómetro y limpiafondos

Pool maintenance kit: pH/Cl Test kit, 45 cm Brush, leaf net, thermometer and Vacuum head

Kit de nettoyage pour piscines: analyse pH/Cl, brosse 45 cm, époussette de surface, thermomètre et balai manuel

Kit di mantenimento per piscine: analizzatore ph/cl, spazzola 45 cm, raccogliatore di supercie, termometro e puliscifondo

## LIMPIAFONDOS VENTURY VENTURY VACUUM ASPIRATEURS DE FOND VENTURY PULISCIFONDI VENTURY

REF. 08050

CS PACK 6

8427370080500

Kit piscina autoportante: analizador pH/Cl, cepillo, recogehojas de superficie, mango 1,20m (3 tramos) termómetro tubular, dosificador y jet vac ventury.

Kit spécial piscine autoportante: trousse d'analyse pH/Cl, brosse, épaisseur de surface, manche 1,20m (3 parties), thermomètre tubulaire, doseur pastilles rétractable and jet vac ventury.

Special inflatable pool kit: pH/chlorine test kit, brush, leaf net, tubular thermometer, 1,20m handle (3 sections), floating dispenser and ventury vacuum.

Kit speciale per piscina autoportante: analizzatore pH/Cl, spazzola, Raccogliatore di superficie, manico 1,20m (3 sezioni) termometro tubolare, dosatore e aspiratore jet vac ventury.



REF. PSV51

CBX PACK 6

8412081250137

Pool & Spa Vac: Limpiafondos manual con accesorios Incluye: recogedor superficie, boquilla ancha aspiración, cepillo acoplable, soporte para pared.

Pool & Spa Vac: Nettoyeur de fond manuel avec accessoires Il inclut: un ramasseur de surface, un bec large d'aspiration, une brosse et un support pour le mur.

Pool & Spa Vac: Includes: Leaf net+ Suction nozzle+ Attachable brush + Wall bracket.

Pool & Spa Vac: Puliscifondo manuale con accessori Include: rete foglie, bocchetta di aspirazione, spazzola, staffa per muro.



REF. 90111

BX PACK 10

8427370901119

Limpiafondos Micro-Ventury.

Nettoyeur Micro-Venturi.

Micro-Ventury Vacuum.

Puliscifondi Micro-Ventury.



REF. Y15

CBX PACK 12

8412081201214

Kit limpiafondos Ventury+ pértiga.

Kit Aspirateur de fond Venturi + manche.

Ventury vacuum kit + handle.

Aspiratore Ventury+ pertica.



REF. Y10

CBX PACK 6

8412081890180

Limpiafondos Ventury+ pértiga

Aspirateur de fond Venturi + manche.

Ventury vacuum + handle.

Aspiratore Ventury+ pertica.





# matériel de nettoyage materiale di pulizia

## GAMA SUPERLUXE SUPERLUXE RANGE GAMME SUPERLUXE GAMMA SUPERLUXE



Cepillo Luxe de 34 cm  
Brosse Luxe 34 cm

Luxe brush 34 cm  
Spazzola Luxe 34 cm

REF. LBP40

CB PACK 12

8412081241777



Cabezal Luxe aspirador  
manual flexible con cepillos  
Nettoyeur de fonds aspiration  
flexible Luxe avec de brosses

Flexible Luxe suction pool  
cleaner with brushes  
Puliscifondo aspirazione  
Luxe flessibile con spazzole

REF. LAMF10

CS PACK 6

8412081241784



Cabezal Luxe aspirador  
manual triangular flexible  
Nettoyeur de fonds aspiration  
flexible triangulaire Luxe

Flexible Luxe triangular  
suction pool cleaner  
Puliscifondo aspirazione  
Luxe triangolare flessibile

REF. LAMTF10

CB PACK 6

8412081241821



Recogehojas de fondo  
Luxe con malla de nylon  
Époussette de fond Luxe avec  
filet de nylon

Nylon net Luxe  
leaf rake  
Raccoglitore di fondo Luxe  
con la maglia di nylon

REF. LRF10

CB PACK 12

8412081241791



Recogehojas de superficie  
Luxe con malla de nylon  
Époussette de surface Luxe avec  
filet de nylon

Nylon net Luxe  
leaf net  
Raccoglitore di superficie  
Luxe con la maglia di nylon

REF. LRS10

CB PACK 12

8412081241807

**LIMPIAFONDOS MANUALES VACUUM HEADS**  
**BALAIS MANUELS PULISCIFONDO MANUALE**

Limpiafondos triangular rotativo  
 Balai triangulaire rotatif

Triangular swivelling vac head  
 Puliscifondo triangolare rotante

REF. 40016

DIS 1/2N pack 6



8427370400162



Limpiafondos ovalado rotativo con cepillos laterales  
 Balai oval rotatif avec brosses latérales

Oval swivelling vac head with lateral brushes  
 Puliscifondo ovale rotante con spazzole laterali

REF. 40017

DIS 1/2N pack 6



8427370400179



Limpiafondos manual rotativo 8 ruedas con cepillos laterales  
 Balai manuel rotatif 8 roues avec brosses latérales

Swivelling vacuum head 8 wheels with lateral brushes  
 Puliscifondo manuale con 8 ruote e spazzole laterali

REF. 40018

DIS 3/4N pack 12



8427370400186



Limpiafondos de aluminio  
 Balai en aluminium

Aluminium vac head  
 Alluminio puliscifondo

REF. 40022

BX PACK 6



8427370400223

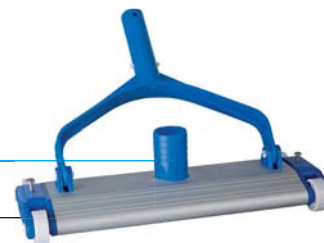

Empuñadura clip Ø28mm  
 Poignée clip Ø28mm

Clip handle Ø28mm  
 Impugnatura clip Ø28mm

REF. 40092

DIS 1/4N pack 20



8427370400926

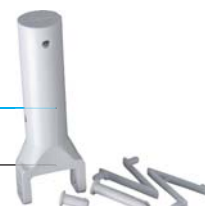

# matériel de nettoyage materiale di pulizia

## CEPILLOS BRUSHES BROSSES SPAZZOLE



Cepillo aluminio  
Brosse aluminium

Aluminium brush  
Spazzola alluminio

REF. 40046

DIS 3/4N pack 12

8427370400469



Cepillo aluminio para  
eliminar algas  
Brosse aluminium pour  
éliminer les algues

Aluminium brush to  
eliminate the algae  
Spazzola alluminio  
per eliminare le alghe

REF. CAA25

DIS 1/2N pack 32

8412081241456



Cepillo aspirante  
Brosse aspirante

Vacuum brush  
Spazzola con attacco per aspirare

REF. 40802

DIS 3/4N pack 10

8427370408021



Cepillo Gran Formato  
Brosse Grand Format

Big Format brush  
Spazzola Gran Formato

REF. 40041

DIS 3/4N pack 12

8427370400414



Cepillo línea de agua  
Brosse ligne d'eau

Waterline brush  
Spazzola per bordo acqua

REF. 40040

DIS 1/4N pack 12

8427370400407



Cepillo aspirador limpia-esquinas  
Brosse aspirante d'angle

Vacuum brush  
Spazzola aspiratutto per angoli

REF. 40806

DIS 1/4N pack 18

8427370408069

# material de limpieza

# cleaning material

## DOSIFICADORES DISPENSERS DOSEURS DOSATORI

Combi Thermo-dosificador: Dosificador  
Capacidad 1,5 Kg (pastillas de 20 a  
500 g) + Termómetro + Visor de  
consumo de producto

Combi Thermo-doseur: Doseur  
Capacité 1,5 Kg (pastilles de 20 à  
500 g) + Thermomètre + Témoin de  
consommation de produit

Combi Thermo-dosifier: Dosifier  
Capacity 1,5 kg (20 500 g tablets) +  
Thermometer + Product  
Consumption Viewer

Combi Thermo-Dosatore Capacità  
1,5 kg (Tavolette da 20 a 500 g)  
+ Termometro + Controllo livello  
del prodotto

REF. 40070

DIS 1/2N PACK 5

8427370400704



Combi Thermo-dosificador: Dosificador  
pastillas de 20 g + Termómetro +  
Visor de consumo de producto

Combi Thermo-doseur: Doseur  
pastilles de 20 g + Thermomètre +  
Viseur de consommation de produit

Combi Thermo-dosifier: Dosifier  
20g tablets + Thermometer +  
Product Consumption Viewer

Combi Thermo-Dosatore Tavolette  
da 20 g + Termometro + Controllo  
livello del prodotto

REF. DCT20

DIS 1/2N PACK 36

8412081241463



Dosificador flotante.  
Capacidad: 7 pastillas de 20 g  
Doseur flottant.  
Capacité 7 pastilles de 20 g

Floating dispenser.  
Capacity: 7 tablets 20 g  
Dosatore galleggiante.  
Capacità 7 pastiglie da 20 g

REF. 40071

DIS 1/2N PACK 30

8427370400711



## TERMÓMETROS THERMOMETERS THERMOMÈTRES TERMOMETRI

Termómetro pez payaso  
Thermomètre de poisson clown

Clown fish thermometer  
Termometro pesce pagliaccio

REF. TBF20

BXL PACK 12

8412081258003

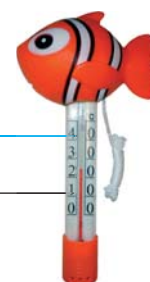

NEW

Termómetro bola  
Thermomètre boule

Ball thermometer  
Termometro a sfera

REF. 40055

CB pack 15

8427370400551



# matériel de nettoyage materiale di pulizia



Termómetro boya  
Thermomètre bouée

Buoy thermometer  
Termometro galleggiante

REF. 40054

DIS 1/2N pack 10

8427370400544



Termómetro tubular flotante  
Thermomètre flottant tubulaire

Tubular floating thermometer  
Termometro galleggiante tubolare

REF. 40051

DIS 1/2N PACK 18

8427370400513



Termómetro "Big"  
Doble lectura  
"Big" Thermomètre  
Double lecture

"Big" thermometer  
Double reading  
Termometro "Big"  
Doppio lettura

REF. 40050

CS pack 12

8427370400506

## MANGOS TELESCÓPICOS TELESCOPIC HANDLES MANCHES TÉLESCOPIQUES MANICO TELESCOPICO



Mango telescópico de aluminio  
Manche télescopique argenté  
**3,60 m (3 x 1,20m)**

Telescopic aluminium handle  
Manico telescopico argentato

REF. 40014

BX pack 12

8427370400148



Mango telescópico de aluminio  
Manche télescopique argenté  
**4,80 m (2 x 2,40m)**

Telescopic aluminium handle  
Manico telescopico argentato

REF. 40011

BX pack 10

8427370400117



Mango telescópico de aluminio  
Manche télescopique argenté  
**3,60 m (2 x 1,80m)**

Telescopic aluminium handle  
Manico telescopico argentato

REF. 40010

BX pack 10

8427370400100



Mango telescópico de aluminio  
Manche télescopique argenté  
**2,40 m (2 x 1,20m)**

Telescopic aluminium handle  
Manico telescopico argentato

REF. 40013

BX pack 20

8427370400131

material de limpieza

cleaning material

## RECOGEHOJAS LEAF NETS AND RAKES ÉPUISETTES RACCOGLITORI

Recogehojas fondo aluminio  
Épuiette de fond aluminium

Aluminium Leaf rake  
Raccogliore di fondo alluminio

REF. RHFAL

DIS 1/1N PACK 12



8412081237688



Recogehojas superficie aluminio  
Épuiette de surface aluminium

Aluminium Leaf net  
Raccogliore di superficie alluminio

REF. RHSAL

DIS 1/1N PACK 12



8412081237671



Recogehojas de superficie  
+ mango telescópico  
Épuiette de surface  
+ manche télescopique

Leaf net  
+ telescopic handle  
Raccogliore di superficie  
+ Manico telescopico

REF. 40031

CB PACK 12



8427370400315



Recogehojas de fondo  
Gran Formato  
Épuiette de fond  
Grand Format

Big format  
Leaf rake  
Raccogliore di fondo  
Gran formato

REF. 40032

DIS 1/1 PACK 12



8427370400322



Recogehojas de superficie  
Gran Formato  
Épuiette de surface  
Grand Format

Big format  
Leaf net  
Raccogliore di superficie  
Gran formato

REF. 40030

DIS 1/1 PACK 12



8427370400308



# matériel de nettoyage [ materiale di pulizia

## MANGUERAS VACUUM HOSES TUYAUX FLOTTANTS TUBI GALLEGGIANTI



Manguera para filtro 4m  
con 2 terminales Ø32mm  
Tuyau pour filtration 4m  
avec 2 embouts Ø32mm

Filter hose 4m  
with 2 cuffs Ø32mm  
Tubo filtrante 4m  
con 2 terminali da Ø32mm

REF. 40181 BX pack 1  8427370401817

Manguera para filtro 4m  
con 2 terminales Ø38mm  
Tuyau pour filtration 4m  
avec 2 embouts Ø38mm

Filter hose 4m  
with 2 cuffs Ø38mm  
Tubo filtrante 4m  
con 2 terminali da Ø38mm

REF. 40180 BX pack 1  8427370401800

Manguera limpiafondos 4m  
con 2 terminales Ø38mm  
Tuyau pour nettoyeur de fond 4m  
avec 2 embouts soudés Ø38mm

Vacuum hose 4m  
with 2 cuffs Ø38mm  
Tubo puliscifondo 4m  
con 2 terminali da Ø38mm

REF. AR212 BX pack 1  8412081240824



Manguera limpiafondos 6m  
con 2 terminales Ø38mm  
Tuyau pour nettoyeur de fond 6m  
avec 2 embouts soudés Ø38mm

Vacuum hose 6m  
with 2 cuffs Ø38mm  
Tubo puliscifondo 6m  
con 2 terminali da Ø38mm

REF. AR210 BX pack 1  8412081960296

Manguera limpiafondos 8m  
con 2 terminales Ø38mm  
Tuyau pour nettoyeur de fond 8m  
avec 2 embouts soudés Ø38mm

Vacuum hose 8m  
with 2 cuffs Ø38mm  
Tubo puliscifondo 8m  
con 2 terminali da Ø38mm

REF. 40001 BX pack 1  8427370400018

Manguera limpiafondos 10m  
con 2 terminales Ø38mm  
Tuyau pour nettoyeur de fond 10m  
avec 2 embouts soudés Ø38mm

Vacuum hose 10m  
with 2 cuffs Ø38mm  
Tubo puliscifondo 10m  
con 2 terminali da Ø38mm

REF. 40002 BX pack 1  8427370400025

Manguera limpiafondos 12m  
con 2 terminales Ø38mm  
Tuyau pour nettoyeur de fond 12m  
avec 2 embouts soudés Ø38mm

Vacuum hose 12m  
with 2 cuffs Ø38mm  
Tubo puliscifondo 12m  
con 2 terminali da Ø38mm

REF. 40003 BX pack 1  8427370400032

Manguera limpiafondos 15m  
con 2 terminales Ø38mm  
Tuyau pour nettoyeur de fond 15m  
avec 2 embouts soudés Ø38mm

Vacuum hose 15m  
with 2 cuffs Ø38mm  
Tubo puliscifondo 15m  
con 2 terminali da Ø38mm

REF. 40004 BX pack 1  8427370400049



# material de limpieza

# cleaning material

Manguera seccionable  
36,5m - Ø38mm  
Tuyau sectionnable  
36,5m - Ø38mm

Sectionable hose  
36,5m - Ø38mm  
tubo sezionabile  
36,5m - Ø38mm

REF. 90160

BX PACK 1



8427370901607

Manguera seccionable  
36,5m - Ø32mm  
Tuyau sectionnable  
36,5m - Ø32mm

Sectionable hose  
36,5m - Ø32mm  
tubo sezionabile  
36,5m - Ø32mm

REF. 90161

BX PACK 1



8427370901614



Kit mangueras filtración  
Kit tuyaux pour épurateurs

Filtration hoses kit  
Kit tubi di filtraggio

2 ( Ø38mm x 4,5m) + 1 ( Ø38mm x 1,5m) + 1 ( Ø38mm x 0,68m) + 1 ( Ø38mm x 0,58m)  
+ 1 ( Ø38mm x 0,40m) + 7 abrazaderas / clamps / colliers / fascette

REF. AR2100

BX PACK 1



8412081202518



Enrollador de mangueras  
flotantes hasta 15m.  
(Manguera no incluida)

Vacuum hoses roller  
maximum 15m.  
(Vacuum hoses not included)

Enrouleur de tuyaux  
flottants. Jusqu'à 15m.  
(Tuyau non inclus)

Avvolgitore per tubo  
galleggiante fino a 15 m.  
(Tubo non incluso)

REF. 90165

CBX PACK 1



8427370901652



Unión 2 mangueras flotantes  
Ø38mm y 32mm  
Liaison pour tuyaux flottants  
Ø38mm et 32mm

2 vacuum hoses union  
Ø38mm and 32mm  
Raccordo per unire 2 tubi  
Ø32mm - 38mm

REF. 40009

DIS PACK 12



8427370400094

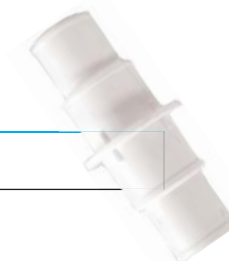

Adaptador de mangueras 38/32mm  
Adaptateur de tuyaux Ø38/32mm

38/32mm hose adapter  
Adattatore per tubo 32/38mm

REF. 40095

BX PACK 20



8427370400957





# matériel de nettoyage materiale di pulizia



Quitavueltas para manguera Ø38mm    Ø38mm hose adaptor with threaded connection  
Raccord tournant pour tuyaux Ø38mm    Adattatore per tubo Ø38mm

REF. 40091    BX PACK 30     8427370400919



Terminal manguera flotante - Ø38mm    Hose cuff - Ø38mm  
Embout tuyau flottant - Ø38mm    Raccordo per tubo Ø38mm

REF. 40012    BX PACK 20     8427370400124



2 conectores Ø38  
+ 4 abrazaderas Ø38  
2 manchons pour branchement  
tuyaux Ø38 + 4 colliers Ø38    2 connectors Ø38  
+ 4 clamps Ø38  
2 raccordi Ø38  
+ 4 fascette Ø38

REF. AR509    CS pack 10     8412081209685



2 conectores Ø38/32 +  
4 abrazaderas Ø38/Ø32  
2 manchons pour branchement  
tuyaux Ø38/32 + 4 colliers Ø38/Ø32    2 connectors Ø38/32  
+ 4 clamps Ø38/ Ø32  
2 raccordi Ø38/32 +  
4 fascette Ø38/Ø32

REF. AR511    CS pack 10     8412081215792



Manguera de conexión  
68 cm - Ø38mm    Connection hose  
68 cm - Ø38mm  
Tuyau de jonction  
68 cm - Ø38mm    Tubo di giunzione  
68 cm - Ø38mm

REF. 60222    PB pack 10     8427370602221

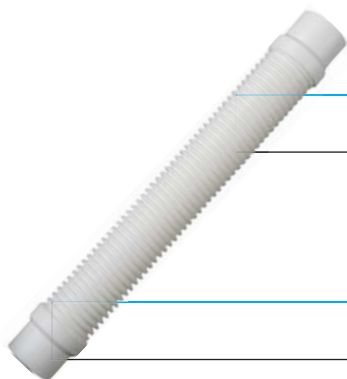

Manguera de conexión  
58 cm - Ø38mm    Connection hose  
58 cm - Ø38mm  
Tuyau de jonction  
58 cm - Ø38mm    Tubo di giunzione  
58 cm - Ø38mm

REF. 60218    PB pack 10     8427370602184

Manguera de conexión  
36 cm - Ø38mm    Connection hose  
36 cm - Ø38mm  
Tuyau de jonction  
36 cm Ø38mm    Tubo di giunzione  
36 cm - Ø38mm

REF. 60205    PB pack 10     8427370602054

## RACORDERÍA PVC FITTINGS

## RACCORDS PVC RACCORDERIA IN PVC



<b>1</b>	Enlace Ø 50 HXH PN16 Raccord PVC Ø 50 HXH PN16	PVC screw Ø 50 mm Raccordo Ø 50 HXH PN16
	REF. 40537	BX PACK 15
	 8427370405372	
	Enlace 3P. Ø 50 macho 1 1/2 PN16 Raccord PVC en 3 parties Ø50 macho 1 1/2 PN16	PVC 3 piece union solvent socket Ø50mm1 1/2 Raccordo 3P. Ø 50 maschio 1 1/2 PN16
	REF. 40538	BX PACK 20
	 8427370405389	
<b>2</b>	Raccordo 3P. Ø 50 maschio 2" PN16 Raccord PVC en 3 parties Ø 50 macho 2" PN16	PVC 3 piece union solvent socket Ø 50mm 2" Raccordo 3P. Ø 50 maschio 2" PN16
	REF. 40539	BX PACK 15
	 8427370405396	
<b>3</b>	Válvula antiretorno Ø 50 PN16 Valve anti-retour Ø 50 PN16	Check valve Ø 50 mm Valvola ritorno Ø 50 PN16
	REF. 40541	BX PACK 8
	 8427370405419	
<b>4</b>	Válvula Ø 50 PN10 Valve anti-retour Ø 50 PN16	PVC ball valve Ø 50 mm Valvola Ø 50 PN10
	REF. 40543	BX PACK 6
	 8427370405433	
<b>5</b>	Racord curva Ø 50 90° PN16 - para encolar Valve anti-retour Ø 50 PN16	PVC elbow fitting 90° Ø 50 mm Valvola Ø 50 PN10
	REF. 40555	BX PACK 10
	 8427370405556	
<b>6</b>	Codo Ø 50 90° PN16 - para encolar Coude PVC à coller Ø 50 90° PN16	PVC 90° elbow solvent socket Ø 50 mm Gomito Ø 50 90° PN16 - da incollare
	REF. 40590	BX PACK 30
	 8427370405907	
	Codo Ø 50 45° PN16 Coude PVC Ø 50 45° PN16	PVC 45° elbow solvent socket Ø 50 mm Gomito Ø 50 45° PN16
	REF. 40591	BX PACK 40
	 8427370405914	
<b>7</b>	Te Ø 50 PN16 - para encolar Raccord en T à coller Ø 50 PN16	PVC-Tee 90° solvent socket Ø 50 mm Raccordo a T Ø 50 PN16 - da incollare
	REF. 40592	BX PACK 24
	 8427370405921	
<b>8</b>	Racord Ø 50 PN16 - para encolar Raccord PVC à coller Ø 50 PN16	PVC union solvent socket Ø 50 mm Raccordo Ø 50 PN16 - da incollare
	REF. 40593	BX PACK 60
	 8427370405938	
<b>9</b>	Válvula Ø50 PN10, manguito rosca macho Vanne Ø50 PN10 embout mal	Ball valve Ø50 mm Valvola Ø50 PN10, tubo filettato maschio
	REF. 40646	BX PACK 8
	 8427370406461	
<b>10</b>	Tubo PVC semirígido Ø 50, 25m Couronne PVC semi-rigide Ø 50, 25m	Semi-rigid PVC hose Ø 50 mm, 25m Tubo PVC semirigido Ø 50, 25m
	REF. 40557	PB PACK 1
	 8427370405570	
	Adhesivo para PVC 250 g Colle PVC 250gr	Blue Adhesive for flexible PVC pipes 250 g Adesivo per PVC 250 g
	REF. 40553	BX PACK 12
	 8427370405532	

# matériel de nettoyage materiale di pulizia

## PROTECCIÓN INVIERNO WINTER PROTECTION PROTECTION HIVER PROTEZIONE PER L'INVERNO



Flotador de hibernaje  
Flotteur d'hivernage

Winterising fl oat  
Gallegiante inverno

REF. 40580

BX PACK 10

8427370405808



Gizzmo - protección del skimmer  
Gizzmo - protection du skimmer

Gizzmo - skimmer protection  
Gizzmo – protezione per skimmer

REF. 40581

BX PACK 35

8427370405815



Tapón de invernaje 1,5"  
Bouchon d'hivernage 1,5"

Winterising plug 1,5"  
Tappo inverno 1.5"

REF. 40582

BX PACK 30

8427370405822



Tapón de invernaje 2"  
Bouchon d'hivernage 2"

Winterising plug 2"  
Tappo inverno 2"

REF. 40583

BX PACK 30

8427370405839





producto químico chemicals  
produits d'entretien prodotti chimici



**MADE  
IN  
EU**

## PASOS PARA CUIDAR DE SU PISCINA STEPS TO TAKE CARE OF YOUR SWIMMING POOL ETAPES À SUIVRE POUR PRENDRE SOIN DE VOTRE PISCINE INDICAZIONI PER IL TRATTAMENTO DELLA PISCINA



Regular el pH  
pH regulation  
Réguler le pH  
Correttori di pH

**1**

Higienizar el agua  
Water sanitizing  
Higiéniser l'eau  
Igienizzazione dell'acqua

**2**

**3a**

**3b**

**3c**

¿Cómo?  
**How?**  
¿Comment?  
¿Come?

Minorador de pH  
**pH reduce**  
Baisse le pH  
Riduttore di pH

Incrementador de PH  
**pH increase**  
Augmente le pH  
Incrementatore pH

Cloro choque  
**Shock chlorine**  
Chlore choc  
Cloro shock

Cloro lento  
**Slow chloration**  
Chlore lent  
Cloro lento

Bromo  
**Bromine**  
Brome  
Bromine

Oxígeno activo  
**Active oxygen**  
Oxygène actif  
Ossigeno attivo

¿Para qué?  
**Why?**  
¿Pourquoi?  
¿Perché?

Obtener un pH entre 7,2 y 7,6  
**To have a pH value between 7,2 and 7,6**  
Obtenir un pH entre 7,2 et 7,6  
Stabilizzare pH tra 7.2 e 7.6

Higienizar rápidamente y destruir los organismos, hongos y bacterias  
**To sanitize quickly and to eliminate all the organisms and bacteria**  
Higiéniser rapidement et détruire les organismes, champignons et bactéries  
igienizzare rapidamente e distruggere tutti gli organismi, funghi e batteri

Desinfectar permanentemente  
**To have a permanent disinfection**  
Désinfecter en permanence  
Disinfezione permanente

¿Cuándo?  
**When?**  
¿Quando?  
¿Quando?

A diario  
**Daily**  
Chaque jour  
Trattamento quotidiano

Al inicio de temporada / Después de condiciones climáticas extremas / Uso intensivo de la piscina  
**At the beginning of the swim season / After bad weather conditions / High use level**  
Début de saison / Après des conditions climatiques extrêmes / Usage intensif de la piscine  
Inizio stagione / Dopo che si sono verificate cambiamenti climatici molto forti / Uso intensivo della piscina

A diario  
**Daily**  
Chaque jour  
Trattamento quotidiano

Resultado  
**Result**  
Résultat  
Risultato

pH ideal para la piel y los ojos. Instalaciones en perfecto estado  
**Ideal pH for skin and eyes. Good conditions equipment**  
pH idéal pour la peau et les yeux. Installations en parfait état  
pH stabile non genera fastidi ad occhi e alla pelle

Agua limpia y libre de posibles contagios  
**Clean water without contagious risk**  
Eau propre et libre de possibles contagions  
Acqua pulita e libera da ogni impurità

Agua limpia y libre de posibles contagios  
**Clean water without contagious risk**  
Eau propre et libre de possibles contagions  
Acqua pulita e libera da ogni impurità

# produits d'entretien [prodotti chimici]



Tratamiento antialgas  
Anti-algae treatment  
Traitement anti-algues  
Trattamento antialghe

Floculación  
Flocculation  
Floculation  
Floculante

Complet 4  
Actions

Total 5 Actions

Total 10 Actions

4

5

Antialgas concentrado  
Concentrated algaecide  
Anti-algues concentré  
Antialghe concentrato

Antialgas Extra  
Extra anti-algae  
Anti-algues Extra  
Antialghe extra

Floculante  
Flocculant  
Floculant  
Floculante

Fórmula innovadora que permite en una sola aplicación, eliminar bacterias, virus y microorganismos en general

Thanks to its new formula, you can eliminate bacteria, virus and microorganisms

Formule innovatrice, il permet avec une

seule application, d'éliminer bactéries, virus et microorganismes en général

Formula innovativa che permette in una sola applicazione

eliminare i batteri, virus e microorganismi in generale

Prevenir la aparición de algas  
To avoid algae apparition  
Prevenir l'apparition  
des algues  
Prevenire la comparsa delle  
alghè

Eliminar las algas existentes  
To eliminate the algae  
Éliminer les algues existantes  
Eliminare la presenza di alghè

Eliminar las partículas  
en suspensión  
To eliminate particles  
in suspension  
Éliminer les particules  
en suspension  
Elimina le impurità

**4 funciones:**  
- Cloro  
- Antialgas  
- Estabilizante  
- Floculante

**4 functions:**  
- Chlorine  
- Antialgae  
- Stabiliser  
- Flocculant

**4 fonctions:**  
- Chlore  
- Anti-algues  
- Stabilisant  
- Floculant

**4 funzioni:**  
- Cloro  
- Antialghe  
- Stabilizzante  
- Floculante

**5 funciones**  
- Cloro  
- Antialgas  
- Estabilizante  
- Floculante  
**Anticalcáreo**

**5 functions:**  
- Chlorine  
- Antialgae  
- Stabiliser  
- Flocculant  
**- Antilime**

**5 fonctions:**  
- Chlore  
- Anti-algues  
- Stabilisant  
- Floculant  
**- Anticalcaire**

**5 funzioni:**  
- Cloro  
- Antialghe  
- Stabilizzante  
- Floculante  
**- Anticalcare**

**10 funciones:**  
- Bactericida - Regulador de pH  
- Floculante - Estabilizante de cloro  
- Coagulante - Anticalcáreo  
- Algicida - Virucida  
- Algistático - Fungicida

**10 functions:**  
- Germicide - pH regulator  
- Flocculent - Chlorine stabilizer  
- Coagulant - Anti-Limescale Agent  
- Algicide - Virucide  
- Algistatic - Fungicide

**10 fonctions:**  
- Bactéricide - Régulateur de pH  
- Floculant - Stabilisant de chlore  
- Coagulant - Anticalcaire  
- Algicide - Virucide  
- Algistatique - Fongicide

**10 funzioni:**  
- Battericida - Regolatore de pH  
- Floculante - Stabilizzante del cloro  
- Coagulante - Anticalcare  
- Alghicida - Virucida  
- Alghistatico - Funghicida

Según convenga  
Depending on water quality  
Selon convenance  
Quando necessario

Semanalmente  
Weekly  
Chaque semaine  
Settimanalmente

Agua sin algas  
Water without algae

Agua cristalina  
Crystalline water

## Cálculo de volumen de agua

Para un correcto suministro del producto químico, es importante calcular el volumen de agua de la piscina.

## Calculate the pool water volume

It is important to calculate the pool water volume to do a correct chemical treatment.

## Calcul de volume d'eau

Pour un bon dosage du produit chimique, il est nécessaire de calculer le volume d'eau de la piscine.

## Calcolo del volume d'acqua

Per un corretto dosaggio del prodotto chimico è importante calcolare il volume d'acqua di una piscina.

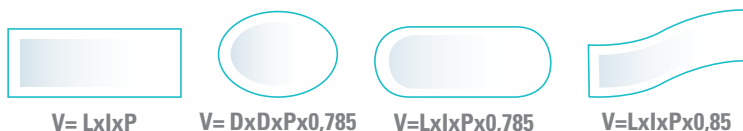

<b>V</b>	Volumen en m <sup>3</sup>	Volume in m <sup>3</sup>	Volume en m <sup>3</sup>	Volume in m <sup>3</sup>
<b>L</b>	Longitud en m	Length in m	Longueur en m	Lunghezza in m
<b>I</b>	Anchura en m	Width in m	Largeur en m	Larghezza in m
<b>D</b>	Diámetro en m	Diameter in m	Diamètre en m	Diametro in m
<b>P</b>	Profundidad en m	Depth in m	Profondeur en m	Profondità media in m

### Ejemplo Example Exemple Esempio

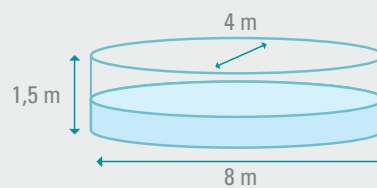

$$1,5 \text{ m} \times 8 \times 4 \times 0,785 = 37,68 \text{ m}^3$$

## LEYENDA LEGEND LÉGENDE LEGENDA



500 g



10 Kg



1 L



1 Kg / 1,5 Kg



1 L



1 kg



2,5 Kg



5 L



1/2 BOX PALET



5 Kg



10 L



**REGULADORES DE PH PH REGULATORS**  
**RÉGULATEURS DE PH CORRETTORI DI PH**

El pH indica la acidez o la basicidad del agua. En una piscina debe mantenerse ajustado entre los valores 7.2 y 7.6, ya que además de conservar las instalaciones en óptimas condiciones, es el ideal para la piel y los ojos de los bañistas.

pH shows if water is acid or basic. Pool water pH must be between 7.2 and 7.6, because it helps to conserve the equipment in good conditions and it is ideal for swimmer eyes and skin.

Le pH indique l'acidité ou la basicité de l'eau. L'eau de la piscine doit se maintenir entre les taux 7.2 et 7.6, car il aide à mieux conserver les installations et est l' idéal pour la peau et les yeux des baigneurs.

Il pH indica la acidità e la basicità dell' acqua. In una piscina il valore di riferimento deve essere sempre tra 7.2 e 7.6, dal momento che, oltre a favorire il trattamento chimico che viene effettuato, è il valore ideale affinché la pelle e gli occhi dei bagnanti non si irritino.



**INCREMENTADOR DE pH pH INCREASE**  
**AUGMENTE LE pH INCREMENTATORE pH**

**pH PLUS**

GRANULADO GRANULES GRANULÉS GRANULATO



Ref. **05914** 1 Kg pack 12  8427370059148



Ref. **05996** 5 Kg pack 4  8427370059964

Incrementador de pH: para aumentar y estabilizar el pH  
 pH increase: to increase and stabilize pH  
 Augmente le pH: pour augmenter et stabiliser le pH  
 Per aumentare e stabilizzare il pH

**MINORADOR DE pH pH REDUCE**  
**BAISSE LE pH RIDUTTORE pH**

**pH MINUS**

GRANULADO GRANULES GRANULÉS GRANULATO



Ref. **05912** 1,5 Kg pack 12  8427370059124



Ref. **05995** 5 Kg pack 4  8427370059957

Minorador de pH: para bajar y estabilizar el pH  
 pH reduce: to lower and stabilize pH  
 Baisse le pH: pour baisser et stabiliser le pH  
 Per abbassare e stabilizzare il pH

7.2

7.6

pH OK

use pH+

use pH-

## Higienizantes Sanitizing Hygiénisation Igienizzanti

Para poder tener un agua transparente y en definitiva libre de posibles contagios, es imprescindible que ésta sea higienizada regularmente. Los productos higienizantes pueden ser de diversos tipos, siendo los más comunes los productos clorados, aunque también existen otras soluciones alternativas, igualmente con un elevado poder higienizante, como el bromo o el oxígeno activo.

In order to have clear water without contagious danger, it is necessary to treat it regularly. There exist several kind of sanitizing, whose most common is chlorine. Other solutions like bromine or oxygen have also a high sanitizing action.

### CLORO CHOQUE SHOCK CHLORINE CHLORE CHOC CLORO SHOCK

El Cloro Choque permite destruir rápida y eficazmente todos los organismos, hongos y bacterias. Conviene realizar una cloración de choque: Al inicio de la temporada de baño / Después de condiciones climáticas extremas / En caso de uso intensivo de la piscina. It eliminates quickly all the organisms and bacteria. It is necessary to do a Shock chloration: At the beginning of the swim season / After bad weather conditions / High use level.

Le Chlore Choc permet de détruire rapidement tous les organismes, champignons et bactéries. Il convient d'effectuer une chloration choc: Au début de la saison de baignade / Après des conditions climatiques extrêmes / En cas d'usage intensif de la piscine.

Permette di eliminare rapidamente ed efficacemente tutti gli organismi, funghi e batteri. E' utile usare questo tipo di prodotto: All'inizio della stagione / Dopo condizioni climatiche estreme / In caso di un uso intensivo della piscina.

#### CLORCHOC

PASTILLAS 20g 20g TABLETS PASTILLES 20g PASTIGLIE 20g



Ref. **08482** 1 Kg pack 12 8427370084829



Ref. **08485** 5 Kg pack 4 8427370084850



Ref. **05203** 5 Kg pack 42 8427370052033

Con un 50% de cloro activo mínimo (tricloro). Disolución instantánea.  
Minimum 50% active chlorine (trichlorine). Instant dissolution.  
50% chlore actif minimum (trichlore). Dissolution instantanée.  
Con un mínimo del 50% di cloro attivo (tricloro). Dissoluzione istantanea.

#### GRANULADO GRANULES GRANULÉS GRANULATO



Ref. **05916** 1 Kg pack 12 8427370059162



Ref. **05917** 5 Kg pack 4 8427370059179

Con un 55% de cloro activo mínimo. Disolución rápida.  
Minimum 55% active chlorine. Quick dissolution.  
55% chlore actif minimum. Dissolution rapide.  
Con un 55% di cloro minimo attivo. Dissoluzione rapida.

Pour avoir une eau transparente et libre de bactéries, il est indispensable que celle-ci soit traitée régulièrement. Il existe plusieurs sortes de hygiénisants, le chlore étant le plus connu. Également, il y a d'autres solutions alternatives avec un haut pouvoir hygiénisant, comme le brome ou l'oxygène actif.

Per avere un' acqua pulita e libera da ogni possibile contagio è indispensabile che quest'ultima sia igienizzata regolarmente. Gli igienizzanti più comuni sono a base di cloro, ma possono essere di diverso tipo dal momento che, esistono altre soluzioni alternative, come per esempio l'ossigeno attivo e il bromo.



### CLORO LENTO TRICHLORINE CHLORE LENT CLORO LENTO

Para conseguir una higienización preventiva y continua del agua, es necesario mantener una tasa de cloración libre. Por ello, conviene efectuar una cloración permanente o "cloración lenta".

To have a preventive and continue sanitizing, it is necessary to keep a free chloration value. For this reason, people must do a permanent chloration or a "slow chloration".

Pour avoir une hygiénisation préventive et continue, il est nécessaire de maintenir un taux de chloration libre. Pour cette raison, il faut effectuer une chloration permanente ou «chloration lente».

Per ottenere una igienizzazione preventiva e continua dell'acqua, è necessario mantenere un valore di cloro "libero". Per questo è bene effettuare una clorazione continua o una "clorazione lenta".

#### CLORLENT

TABLETAS 200g 200g TABLETS GALETS 200g PASTIGLIE 200g



Ref. **05922** 1 Kg pack 12 8427370059223



Ref. **05923** 5 Kg pack 4 8427370059230

#### GRANULADO GRANULES GRANULÉS GRANULATO



Ref. **05920** 1 Kg pack 12 8427370059209



Ref. **05921** 5 Kg pack 4 8427370059216



## BROMO BROMINE BROME BROMO

Diferencias respecto al cloro: menos olor, no daña la piel ni el cabello. Más eficacia en las aguas calientes y/o calcáreas.  
Differences compared to chlorine: less smell, does not dry out skin and hair. More efficient in hot and/or calcareous water.  
Différences par rapport au chlore: moins d'odeur, ne dessèche pas la peau ni les cheveux. Plus efficace dans les eaux chaudes et/ou calcaires.  
Differenze rispetto al cloro: meno odore, non danneggia la pelle né i capelli. Più efficace con l'acqua molto calda e/o calcarea.

### BROM'LENT

PASTILLAS 20g 20g TABLETS PASTILLES 20g PASTIGLIE 20g



Ref. **05531** 1 Kg pack 12  8427370055317



Ref. **05526** 5 Kg pack 4  8427370055263

GRANULADO GRANULES GRANULÉS GRANULATO



Ref. **05508** 5 Kg pack 4  8427370055089



### BROM MULTIACTIONS

PASTILLAS 20g 20g TABLETS PASTILLES 20g PASTIGLIE 20g



Ref. **30198** 5 Kg pack 4  8427370301988

Bromo multi-Acciones  
Bromine multi-Actions  
Brome multi-Actions  
Bromo multi funzioni

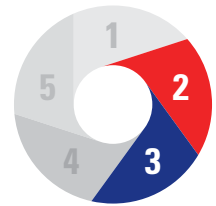

## OXÍGENO ACTIVO ACTIVE OXYGEN OXYGÈNE ACTIF OSSIGENO ATTIVO

Ofrece muchas ventajas, ya que proporciona una desinfección muy eficaz y a diferencia del cloro, no provoca irritaciones oculares ni desprende olores desagradables. Producto que necesita de un dosificador.

This product offers a lot of advantages. It disinfects pool water and contrary to chlorine, it does not cause eye irritation neither and bad smells. This product needs a dispenser.

Ce produit offre beaucoup d'avantages par rapport au chlore, car il ne provoque aucune irritation oculaire, ôte les mauvaises odeurs et en même temps fait une désinfection très efficace. Il a besoin d'un doseur  
Offre molti vantaggi, dal momento che sviluppa una igienizzazione molto efficace e, a differenza del cloro, non irrita gli occhi e non ha un odore sgradevole. È un prodotto che necessita del dosatore.

### ACTI OXY

LÍQUIDO LIQUID LIQUIDE LIQUIDO



Ref. **05936** 5 L pack 4  8427370059360

### OXY CHOC

LÍQUIDO LIQUID LIQUIDE LIQUIDO



Ref. **05938** 5 L pack 4  8427370059384

### OXY LENT

PASTILLAS 20g 20g TABLETS PASTILLES 20g PASTIGLIE 20g



Ref. **05937** 1,2Kg pack 12  8427370059377

**Multifunciones Multiactions**  
**Multi-actions Multi funzioni**

Se trata de un producto revolucionario, ya que gracias a su fórmula innovadora permite en una sola aplicación, eliminar las bacterias, virus y microorganismos en general, evitar el desarrollo de algas, al mismo tiempo que mantiene transparente y cristalina el agua.  
Revolution product: Thanks to its new formula, allows in a single application eliminate bacteria, virus and micro organisms, avoid algae and have clear and crystalline water.

Il s'agit d'un produit révolutionnaire. Grâce à sa formule innovatrice, il permet avec une seule application, d'éliminer les bactéries, virus et micro organismes en général, d'éviter l'apparition d'algues, ainsi que de conserver l'eau transparente et cristalline.

Si tratta di un prodotto rivoluzionario proprio perché, grazie alla sua formula innovatrice, permette, in una sola applicazione, di eliminare i batteri, virus e tutti i microrganismi evitando il proliferare di alghe, mantenendo allo stesso tempo l'acqua trasparente e cristallina.

**COMPLET 4 ACCIONES COMPLET 4 ACTIONS**  
**COMPLET 4 ACTIONS COMPLET 4 AZIONI**

Cloro + Antialgas + Estabilizante + Floculante  
Chlorine + Antialgae + Stabiliser + Flocculant  
Chlore + Anti-algues + Stabilisant + Flocculant  
Cloro + Antialghe + Stabilizzante + Flocculante

**COMPLET 4 ACTIONS**

1 BLOQUE 500g 500g 1 BLOCK 1 BLOC 500g PASTIGLIA 500g 1



Ref. **07621** 0,5 Kg pack 48  8427370076213

TABLETAS 200g 200g TABLETS GALETS 200g PASTIGLIE 200g



Ref. **05520** 1 Kg pack 12  8427370055201



Ref. **06641** 5 Kg pack 4  8427370066412



Ref. **05200** 5 Kg pack 42  8427370052002



Ref. **05521** 10 Kg pack 2  8427370055218

PASTILLAS 20g 20g TABLETS PASTILLES 20g PASTIGLIE 20g



Ref. **05523** 1 Kg pack 12  8427370055232



Ref. **05524** 5 Kg pack 4  8427370055249

**GRANULADO GRANULES GRANULÉS GRANULATO**



Ref. **05522** 5 Kg pack 4  8427370055225



**COMPLET 4 ACTIONS- SPECIAL LINER**

TABLETAS 200g 200g TABLETS GALETS 200g PASTIGLIE 200g



Ref. **05662** 1 Kg pack 12  8427370056628



Ref. **05663** 5 Kg pack 4  8427370056635

Sin sulfato de cobre  
Without copper sulphate.  
Sans sulfate de cuivre  
Senza solfato di rame

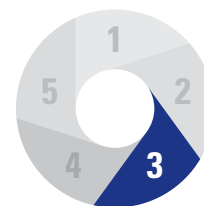

**TOTAL 5 ACCIONES TOTAL 5 ACTIONS**  
**TOTAL 5 ACTIONS TOTAL 5 AZIONI**

Cloro + Antialgas + Estabilizante + Flocculante + Antical  
Chlorine + Antialgae + Stabiliser + Flocculant + Anti lime  
Chlore + Anti-algues + Stabilisant + Flocculant + Anti-calcaire  
Cloro + Antialghe + Stabilizzante + Flocculante + Anticalcare

**TOTAL 5 ACTIONS**

TABLETAS 200g 200g TABLETS GALETS 200g PASTIGLIE 200g



Ref. **06640** 5 Kg pack 4 8427370066405



Ref. **06642** 10 Kg pack 2 8427370066429



**MULTIFUNCIONES BICAPA**  
**TWO-LAYER MULTI-ACTIONS**  
**MULTI-ACTIONS BICOUCHE**  
**MULTI FUNZIONI DOPPIO STRATO**

Cloro multifunción + choque  
Multiactions + shock chlorine  
Chlore multi-actions + choc  
Cloro multi funzioni + shock

**MULTIACTIONS + CHOC**

TABLETAS 250g 250g TABLETS GALETS 250g PASTIGLIE 250g



Ref. **06646** 1 Kg pack 6 8427370066467



Ref. **06643** 5 Kg pack 4 8427370066436



**TOTAL 10 ACCIONES TOTAL 10 ACTIONS**  
**TOTAL 10 ACTIONS TOTAL 10 AZIONI**

Desinfectante + Bactericida + Flocculante + Coagulante + Algicida + Algistático + Regulador de pH + Estabilizante de cloro + Anticalcáreo + Virucida + Fungicida  
Disinfectant+ Germicide + Flocculent + Coagulant + Algicide + Algistatic + pH regulator + Chlorine stabilizer + Anti-Limescale Agent + Virucide+ Fungicide  
Désinfectant + Bactéricide + Flocculant + Coagulant + Algicide + Algistatique + Régulateur de pH + Stabilisant de chlore + Anticalcaire + Virucide + Fongicide  
Disinfettante + Battericida + Flocculante + Coagulante + Alghicida + Alghistatico + Regolatore del pH + Stabilizzante del cloro + Anticalcare + Virucida + Funghicida

**TOTAL 5 ACTIONS**

TABLETAS 250g 250g TABLETS GALETS 250g PASTIGLIE 250g



Ref. **05527** 2,5Kg pack 4 8427370055270



Ref. **05525** 5 Kg pack 4 8427370055256

**Tratamiento antialgas Anti-algae treatment**  
**Traitement anti-algues Trattamento antialghe**

Las algas son organismos vegetales unicelulares que pueden desarrollarse y multiplicarse rápidamente en el agua, sobre todo cuando su temperatura es templada.

Algae are vegetal unicellular organisms that can quickly develop and multiply themselves in the water, specially when the temperature of the water is warm.

Les algues sont des organismes végétaux unicellulaires qui peuvent apparaître et se multiplier très rapidement dans l'eau, surtout quand la température de l'eau est tempérée.

Le alghe sono organismi vegetali unicellulari che possono svilupparsi e moltiplicarsi soprattutto quando la temperatura dell'acqua è abbastanza calda.



**ANTIALGAS ANTI ALGAE**  
**ANTI-ALGUES ANTIALGHE**

**ANTIALG**

LÍQUIDO LIQUID LIQUIDE LIQUIDO



Ref. **05926** 1 L pack 12 8427370059261



Ref. **05927** 5 L pack 4 8427370059278



Ref. **05202** 5 L pack 48 8427370052026

Para prevenir la aparición de algas.  
 To prevent the appearance of algae  
 Pour prévenir l'apparition d'algues.  
 Per prevenire la comparsa delle alghe.

**STOP AGUAS VERDES STOP GREEN WATERS**  
**STOP EAUX VERTES STOP ACQUA VERDI**

**STOP EAUX VERTES**

LÍQUIDO LIQUID LIQUIDE LIQUIDO



Ref. **05510** 5 L pack 4 8427370055102

Oxígeno activo: acción sin cloro  
 Active oxygen: without chlorine  
 Oxygène actif: action sans chlore  
 Ossigeno attivo: azione senza cloro



**ANTIALGAS EXTRA EXTRA ANTI ALGAE**  
**ANTI-ALGUES EXTRA ANTIALGHE EXTRA**

**ANTIALG XTRA**

LÍQUIDO LIQUID LIQUIDE LIQUIDO



Ref. **05928** 1 L pack 12 8427370059285



Ref. **05929** 5 L pack 4 8427370059292

3 acciones. Extra: para eliminar todas las algas.  
 3 actions. Extra: to eliminate the algae.  
 3 actions. Extra: pour éliminer la totalité des algues.  
 3 azioni. Extra. Per eliminare tutti i tipi di alghe.

## Floculante Flocculant Floculant Flocculante

La floculación permite obtener un agua cristalina. Existen dos tipos de floculación: la que se realiza dentro del filtro y la floculación dentro del vaso. La primera permite aumentar la fineza de filtración y eliminar de esta manera las partículas más finas. Ésta se efectúa gracias a los cartuchos floculantes (incompatibles con filtros de cartucho) colocados en el cesto del skimmer. La segunda permite agrupar entre ellas las impurezas que no pueden ser filtradas individualmente y que son el origen de un agua turbia. Esta operación se efectúa con el floculante líquido.

Flocculation allows to obtain a crystalline water. There are two kind of flocculation: inside the filter and in the pool. With the first one we increase the fineness of filtration in order to eliminate smaller particles. For this process we introduce flocculants cartridges (incompatible with cartridge filters) in the skimmer basket. The second one helps us to group all the impurities that are the beginning of brown water thanks to liquid flocculant.

La floculation permet d'obtenir une eau cristalline. Il y a deux types de floculation: celle qui se fait dans le filtre et la floculation dans le bassin. La première permet d'augmenter la finesse de filtration et d'éliminer de cette façon les particules plus fines. S'effectue grâce aux cartouches floculantes (incompatibles avec les filtres à cartouche) dans le panier du skimmer. La deuxième permet de regrouper entre elles les impuretés qui ne peuvent pas être filtrées et qui sont l'origine des eaux troubles. Cette opération se fait avec le floculant liquide.

La flocculazione permette di ottenere un'acqua cristallina. Esistono due tipi di flocculazione: quella che si realizza all'interno del filtro e quella diluendo il prodotto in un contenitore. La prima permette di migliorare la filtrazione ed eliminare le particelle più fini e si effettua grazie alle cartucce floculanti (incompatibili con i filtri a cartuccia) poste dentro il cesto dello skimmer. La seconda permette di raggruppare tra loro le impurità che non possono essere filtrate individualmente e che sono la causa dell'acqua torbida. Questo procedimento si effettua con il flocculante liquido.



## TABLETAS FLOCULANTES FLOCCULANT TABLETS TABLETES DE FLOCCULANT FLOCCULANTE IN PASTIGLIE

### SUPER FLOCULANT

10 TABLETAS 20g 20g 10 TABLETS 10 GALETS 20g 10 PASTIGLIE 20g

 Ref. **05666** 200g pack 24  8427370056666

Tabletas de floculante superconcentradas.  
Super-concentrated flocculant tablets.  
Tablettes de floculant super concentrées.  
Flocculante in pastiglie superconcentrate.

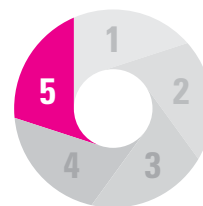

## FLOCULANTE LÍQUIDO LIQUID FLOCCULANT FLOCCULANT LIQUIDE FLOCCULANTE LIQUIDO

### FLOCCULANT

LÍQUIDO LIQUID LIQUIDE LIQUIDO

 Ref. **05932** 1 L pack 12  8427370059322

 Ref. **05933** 5 L pack 4  8427370059339

Para clarificar el agua y eliminar las materias en suspensión.  
Recupera el agua turbia.  
To clarify water and eliminate substances in suspension.  
Retrieve the cloudy water.  
Pour clarifier l'eau et éliminer les matières en suspension.  
Récupère l'eau trouble.  
Rende acqua cristallina ed elimina le particelle in superficie.  
Recupera l'acqua torbida.

CARTUCHOS 125g 125g CARTRIDGES CARTOUCHES 125g CARTUCCIA 125g

 Ref. **07445** 1 Kg pack 24  8427370056666

Para mejorar la calidad de filtración (filtros de arena únicamente).  
Producto de mantenimiento.  
To increase filtration quality (sand filters only).  
Product Maintenance.  
Pour améliorer la qualité de filtration (filtres à sable uniquement).  
Produit de maintenance.  
Per migliorare la qualità della filtrazione (solo per filtri a sabbia).  
Prodotto di mantenimento.

**PRODUCTOS COMPLEMENTARIOS COMPLEMENTARY PRODUCTS**  
**PRODUITS COMPLÉMENTAIRES PRODOTTI COMPLEMENTARI**

**DESINCRUSTANTE DE SUPERFICIE**  
**SURFACE DESCALER**  
**DÉTARTRANT DE SURFACE**  
**PULITORE SUPERFICI D'ACQUA**

**DETRATANT SURFACE**

LÍQUIDO LIQUID LIQUIDE LIQUIDO



Ref. **08487** 1 L pack 12  8427370084874



Ref. **05930** 5 L pack 4  8427370059308

Para eliminar incrustaciones de cal.  
 To eliminate lime scales.  
 Pour éliminer les incrustations calcaires.  
 Per evitare la incrostazione del calcare.

**LIMPIADOR DE BORDES**  
**WATERLINE CLEANER**  
**NETTOYANT LIGNE D'EAU**  
**PULITORE SUPERFICI D'ACQUA**

**NETTOYANT LIGNE D'EAU**

LÍQUIDO LIQUID LIQUIDE LIQUIDO



Ref. **05931** 1 L pack 12  8427370059315

Para eliminar la suciedad de la línea de flotación.  
 To eliminate the dirt on the waterline.  
 Pour éliminer la saleté sur la ligne d'eau.  
 Per eliminare particelle in superficie.



**ANTICALCÁREO ANTI LIME**  
**ANTI-CALCAIRE ANTICALCARE**

**ANTICALC**

LÍQUIDO LIQUID LIQUIDE LIQUIDO



Ref. **08488** 1 L pack 12  8427370084881



Ref. **08499** 5 L pack 4  8427370084898

Para evitar la formación de cal.  
 Secuestrante de metales (hierro, cobre...)  
 To prevent lime formation.  
 Metal Sequestering Agents (iron, copper...)  
 Pour éviter la formation de calcaire.  
 Séquestrant de métaux (fer, cuivre, etc.)  
 Evita la formazione del calcare.  
 Sequestrante di metalli (ferro, rame)



**PRODUCTO QUÍMICO PARA EL INVIERNO CHEMICAL PRODUCTS FOR WINTER**  
**PRODUITS CHIMIQUES POUR L'HIVER PRODOTTI CHIMICI PER L'INVERNO**

Le facilitará la puesta en marcha de la piscina después del invierno, evitando la formación de algas y de cal.  
 Realizar el proceso cuando la temperatura del agua de la piscina sea inferior a 15°C.

- 1) Limpiar la piscina.
- 2) Ajustar el pH entre 7,2 - 7,6
- 3) Realizar una cloración de choque
- 4) Dejar en funcionamiento el fi ltro hasta el día siguiente 5)

Realizar una limpieza del fi ltro

- 6) Añadir el invernador

It makes easier for you the start-up of the pool after winter, avoiding algae and lime formation.

Please carry out the following if the temperature of the water drops below 15°C.

- 1) Clean the swimming pool
- 2) Set the pH balance between 7.2 – 7.6
- 3) Carry out a chlorine crash course
- 4) Leave the fi lter running until the following day
- 5) Clean the fi lter
- 6) Add the winterizing agent

Vous facilite la mise en route de la piscine après l'hiver en évitant la formation d'algues et de calcaire.

Réaliser le processus lorsque la température de l'eau de la piscine est inférieure à 15°C.

- 1) Nettoyer la piscine
- 2) Ajuster le pH entre 7,2 - 7,6
- 3) Réaliser une chloration de choc
- 4) Laisser fonctionner le fi ltre jusqu'au lendemain
- 5) Nettoyer le fi ltre
- 6) Ajouter l'hivernant

Renderà piú semplice l'inizio della nuova Stagione, dopo l'inverno, evitando la formazione di alghe e calcare.

Realizzare la procedura quando la temperatura dell'acqua della piscina è inferiore a 15°C.

- 1) Pulire la piscina
- 2) Regolare il pH tra 7,2 e 7,6
- 3) Eff ettuate una clorazione d'urto
- 4) Lasciare in funzione il fi ltro fi no al giorno successivo
- 5) Eff ettuate una pulizia del fi ltro
- 6) Aggiungere lo svernante



**INVERNADOR WINTERISER**  
**HIVERNAGE TRATTAMENTO PER L'INVERNO**

**HIVERNAGE**

LÍQUIDO LIQUID LIQUIDE LIQUIDO



Ref. **07446** 1 L pack 12  8427370074462



Ref. **07449** 5 L pack 4  8427370074493

**INVERNADOR CON BOYA FLOAT WINTERISER**  
**BOUÉE HIVERNAGE TRATTAMENTO PER L'INVERNO GALLEGGIANTE**

**HIVER FLOAT**

LÍQUIDO LIQUID LIQUIDE LIQUIDO



Ref. **05528** 2 Kg pack 6  8427370055287

**SOLUCIONES DE TRATAMIENTO TREATMENT SOLUTIONS**  
**SOLUTIONS DE TRAITEMENT TRATTAMENTI VARI**

REF. **NLA100**

DIS PACK **12**

3760120430329

Limpiador línea de agua con aplicador  
 Nettoyant ligne d'eau avec applicateur

Waterline cleaner with applicator  
 Pulitore linea d'acqua con applicatore



REF. **90178**

DIS PACK **12**

3760120430275

Repulsivo Anti Insectos a base de aceites esenciales 100% naturales.  
 Caja de 6 pastillas de 30g.  
 Répulsif Anti Insectes à base d'huiles essentielles 100% naturelles.  
 Boite carton de 6 pastilles de 30g.

Anti Insect repellent using 100% natural essential oils.  
 30g 6 tablet box.  
 Repellente anti-insetti a base di oli essenziali 100% naturali.  
 Confezione di 6 pastiglie da 30g.



REF. **90175**

DIS PACK **14**

3760120430305

Repulsivo Anti Insectos a base de aceites esenciales 100% naturales.  
 Dosificador de 3 pastillas de 30g.  
 Répulsif Anti Insectes à base d'huiles essentielles 100% naturelles.  
 Doseur de 3 pastilles de 30g.

Anti Insect repellent using 100% natural essential oils.  
 30 g 3 tablet dosifier.  
 Repellente anti-insetti a base di oli essenziali 100% naturali.  
 Dosatore di 3 pastiglie da 30g.



# produits d'entretien [prodotti chimici]



REF. 90147

DIS PACK 12

3760120430282

### Stop Aguas Verdes

Recupera las aguas verdes gracias a una nueva generación de polimeros hidrosolubles.

Caja de 6 pastillas de 20g.

### Stop Eau Vertes

Il récupère les eaux vertes grâce à une nouvelle génération de polymères hydrosolubles.

Boite carton de 6 pastilles de 20g.

### Stop Green Waters

Get back the green waters of your pool thanks to a new generation of water soluble polymers.

20g 6 tablet box.

### Stop Acque Verdi

Recupera le acque verdi grazie ad una nuova generazione di polimeri idrosolubili.

Confezione di 6 pastiglie da 20g.



REF. 90143

DIS PACK 12

3760120430299

### Stop Aguas Turbias

Recupera las aguas turbias, y consigue un agua limpia y cristalina.

Caja de 6 pastillas de 30g.

### Stop Eau Troubles

Traite les eaux troubles, et rend l'eau propre et cristalline.

Boite carton de 6 pastilles de 30g.

### Stop Cloudy Waters

Get back the cloudy waters to obtain a crystal-clear water.

30g 6 tablet box.

### Stop Acque Torbide

Recupera le acque torbide, la sua efficacia permette di avere un'acqua limpida e cristallina.

Confezione di 6 pastiglie da 30g.

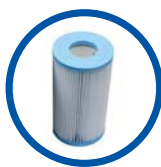

REF. SATC6

DIS PACK 12

3760120430343

### Stop Aguas Turbias

Recupera las aguas turbias, y consigue un agua limpia y cristalina. Para piscinas con filtro de cartucho.

Caja de 6 pastillas de 17g.

### Stop Eau Troubles

Traite les eaux troubles, et rend l'eau propre et cristalline. Pour les piscines avec filtre à cartouche.

Boite carton de 6 pastilles de 17g.

### Stop Cloudy Waters

Get back the cloudy waters to obtain a crystal-clear water. For pools with cartridge filter.

17g 6 tablet box.

### Stop Acque Torbide

Recupera le acque torbide, la sua efficacia permette di avere un'acqua limpida e cristallina. Per le piscine con filtro a cartuccia.

Confezione di 6 pastiglie da 17g.

REF. UFG90

DIS PACK 36

8412081258126

**Ultraflock**

Gel floculante en monodosis de 90g.

**Ultraflock**

Flocculant Gel 90g pods.

**Ultraflock**

Floculant Gel gousses de 90g.

**Ultraflock**

90g flocculante gel.



REF. CP150

DIS PACK 24

8412081258133

**Clear Pools**

Floculante liquido monodosis de 150 ml.

**Clear Pools**

150ml Liquid flocculant.

**Clear Pools**

Floculant liquide gousses de 150ml.

**Clear Pools**

150ml flocculante liquido.



REF. KITSPA

PACK 2

8412081241890

**Kit para SPA**

Oxígeno tabletas 20gr (1kg) + Minorador de pH granulado (1,5kg) + Antiespumante (500ml) + Algicida no espumante (1l) + Anticalcáreo (500ml) + Estuche analizador Cl/Br/Ox/pH

**SPA Kit**

Oxygen 20gr tablets (1kg) + pH reduce granules (1,5kg) + Antifoam (500ml) + Non-foaming algaecide (1l) + Anti lime (500ml) + Cl/Br/Ox/pH test kit

**Kit pour Spa**

Oxygène galets 20gr (1kg) + Baisse le pH granulés (1,5kg) + Antimousse (500ml) + Algicide non moussant (1l) + Anti-calcaire (500ml) + Trousse de Cl/Br/Ox/pH

**Kit per Spa**

Ossigeno pastiglie da 20gr (1kg) + Riduttore pH granulato (1,5kg) + Antischiuma (500ml) + Non schiumogeno algicida (1l) + Anticalcare (500ml) + Kit analisi Cl Br/Ox/pH



# produits d'entretien [ prodotti chimici

- Solución de tratamiento "Todo en Uno". Ideal piscinas elevadas con o sin filtración. Tratamiento mensual.

- 4 Acciones: Desinfectante, Antibacterias, Antialgas y Floculante

- No hay manipulación directa de producto químico.

No perjudica la filtración gracias a su forma optimizada que deja el circuito de agua intacto. El POOLP'O sube a la superficie una vez acabado el producto químico, avisando de la necesidad de empezar un nuevo tratamiento.

- Solution de traitement "Tout en Un". Idéal Piscines hors-sol avec ou sans filtration. Traitement mensuel.

- 4 Actions: Désinfectant, Anti-bactéries, Anti-algues, Floculant.

- Pas de manipulation directe de produit chimique.

Ne gêne pas la filtration grâce à sa forme optimisée qui laisse le circuit de l'eau intact. Ne gêne pas le volet du skimmer de part sa petite taille. Le POOLP'O remonte à la surface une fois le produit consommé vous avisant de la nécessité de recommencer un traitement.

- Treatment solution "All in One" for Above ground Pools with and without filtration. Monthly treatment.

- 4 actions: Disinfecting, Anti-bacteria, Anti-algae and Flocculant.

- No direct handling of chemical product. It does not obstruct filtration thanks to its form optimized – which leaves the circuit of water intact.

It goes up once product finished, so you know you should start a new treatment.

- Soluzione "Tutto in uno". Adatto per piscine fuori terra con o senza filtrazione. Trattamento mensile

- 4 azioni: Disinfettante, Anti-batteri, Antialghe e Floculante

- Non c'è contatto diretto con il prodotto chimico. Non danneggia la filtrazione grazie alla sua forma che lascia libero il circuito dell'acqua.

El Poolp'o sale in superficie una volta terminato il prodotto chimico, avisando della necessità di dover iniziare un nuovo trattamento

REF. 08012

BX PACK 16

8427370080128

**POOLP'O 0-10m<sup>3</sup> (250g)**

**POOLP'O 0-10m<sup>3</sup> (250g)**

POOLP'O 0-10m<sup>3</sup> (250g)

POOLP'O 0-10m<sup>3</sup> (250g)



REF. 08112

DIS 18

8427370081125

Display **POOLP'O 0-10m<sup>3</sup> (250g)**

18 unidades

POOLP'O 0-10 m<sup>3</sup> (250g) Display 18 unités

Display **POOLP'O 0-10 m<sup>3</sup> (250g)**

18 units

Display **POOLP'O 0-10 m<sup>3</sup> (250g)** 18 unità

REF. 08013

BX PACK 16

8427370080135

**POOLP'O 10-20m<sup>3</sup> (500g)**

**POOLP'O 10-20m<sup>3</sup> (500g)**

POOLP'O 10-20m<sup>3</sup> (500g)

POOLP'O 10-20m<sup>3</sup> (500g)



REF. 08113

DIS 18

8427370081125

Display **POOLP'O 10-20m<sup>3</sup> (500g)**

18 unidades

POOLP'O 10-20m<sup>3</sup> (500g) Display 18 unités

Display **POOLP'O 10-20m<sup>3</sup> (500g)**

18 units

Display **POOLP'O 10-20m<sup>3</sup> (500g)** 18 unità

REF. 08099

BX PACK 9

8412081250885

**POOLP'O 10-30m<sup>3</sup> (700g)**

Dosificador flotante con tratamiento químico. Duración 3 semanas

**POOLP'O 10-30m<sup>3</sup> (700g)**

Doseur flottant chimique tout en un. Durée 3 semaines.

**POOLP'O 10-30m<sup>3</sup> (700g)**

Chemical treatment floating dispenser. 3 weeks

**POOLP'O 10-30m<sup>3</sup> (700g)**

Dispenser galleggiante con trattamento chimici. 3 settimane.



REF. 08730

PACK 12

8427370087301

**Kit para piscina de 0 a 5m<sup>3</sup>**

Cloro lento pastillas de 5 g - 500 g  
+ Dosificador + Pelota

**Kit pour piscine de 0 à 5m<sup>3</sup>**

Chlore lent pastilles de 5 g - 500 g  
+ Doseur + Ballon

**Kit for 0-5m<sup>3</sup> pool**

Trichlorine 5g tablets - 500 g +  
Dispenser + Ball

**Kit per piscine da 0 a 5m<sup>3</sup>**

Cloro lento pastiglie da 5 g - 500g +  
dosatore + palla gonfiabile



REF. 08731

PACK 6

8427370087318

**Kit para piscina de 5 a 15m<sup>3</sup>**

Multifunciones pastillas 20g,  
1Kg + Dosificador + Termómetro  
+ Analizador + Manguitos + Kit  
reparación liner

**Kit pour piscine de 5 à 15m<sup>3</sup>**

Multifonction pastilles 20g, 1 kg +  
Doseur + Thermomètre + Trousse  
d'analyse + Brassards + Kit réparation  
liner

**Kit for 5-15m<sup>3</sup> pool**

Multiactions 20g tablets, 1Kg +  
Dispenser + Thermometer + Test kit  
+ Arm-bands + Liner repair kit

**Kit per piscine da 5 a 15m<sup>3</sup>**

4 azioni pastiglie da 20g, formato 1  
Kg + Dosatore + termometro + Kit  
analisi + Braccioni + Kit riparazione  
liner



REF. 08732

PACK 4

8427370087325

**Kit para piscina de 15 a 30m<sup>3</sup>**

Multifunciones pastillas 20g, 2,5Kg  
+ Cloro choque granulado 2,5 Kg +  
Termómetro + Analizador

**Kit pour piscine de 15 à 30m<sup>3</sup>**

Multifonction pastilles 20g, 2,5 kg +  
Chlore choc granulés 2,5 kg + Doseur  
+ Thermomètre + Trousse d'analyse

**Kit for 15-30m<sup>3</sup> pool**

Multiactions 20g tablets 2,5Kg + Shock  
chlorine granules, 2,5Kg + Dispenser +  
Thermometer

**Kit per piscine da 15 a 30m<sup>3</sup>**

4 azioni pastiglie da 20g, 2,5 Kg  
+ Cloro Shock granulare, 2,5Kg +  
Dosatore + Termometro + Kit analisi



**TESTERS DIGITALES DIGITAL TESTERS**  
**TESTEURS DIGITAL TESTER DIGITALE**

NEW



REF. 38813

CS PACK 6

0909441040036

**Aquacheck**

Lector digital de tiras de análisis TruTest. Analiza los niveles de cloro/bromo libre, valor pH y alcalinidad total.

**Aquacheck**

Digital Test Strip Reader. Tests for: Free Chlorine, pH, Total Alkalinity.

**Aquacheck**

Lecteur digital de bandelettes d'analyse TruTest. Résultats de Chlore/Brome libre, pH et Alcalinité totale.

**Aquacheck**

Digital Test striscia lettore TruTest: cloro / bromo-libero, il pH e l'alcalinità totale.

NEW



REF. 40817

BL PACK 12

0909440208208

Recambio para el Aquacheck True Test: 25 tiras analíticas.

Aquacheck True Test refill: 25 test strips.

Recharge pour Aquacheck TruTest.: 25 languettes d'analyse

Ricarica di Aquacheck TruTest: 25 strisce di analisi.



REF. TD61

CS PACK 8

8412081241067

Tester digital de 6 lecturas: pH, Cloro libre, Salinidad, TDS (Tasa total de solidos disueltos en el agua), ORP, Temperatura

6 readings digital tester: pH, FC (free chlorine), Salinity, TDS (Total dissolve solids), ORP, Temperature

Testeur digital 6 lectures: pH, Chlore libre, Salinité, TDS (total des solidos dissous taux dans l'eau), ORP, Température

Tester digitale 6 lecture: pH, Cloro libero, Salinità, TDS (totale di solidi disciolti tasso in acqua), ORP, Temperatura



REF. TDS10

CS PACK 8

8412081250878

Tester digital para piscinas y spas. Mide el nivel de sal en el agua y la temperatura.

Digital salt tester for pools and spas. Designed to test water salt in pools and spas.

Testeur digital pour piscines et SPA. Mesure le niveau de sel et la température.

Tester digitale. Misuratore unico progettato per esaminare il dosaggio di sale in piscine e vasche di bellezza.

**ANALIZADORES TEST KITS**  
TROUSSES D'ANALYSE KIT TEST

REF. 40060      DIS 1/2N BL PACK 32       8427370400605

Analizador de cloro/bromo + pH (Oto/Phenol)      Test kit chlorine/bromine + pH (Oto/Phenol)  
Trousse chlore/brome + pH (Oto/Phénol)      Kit analisi cloro/bromo + pH (oto/Phenol)



REF. 40061      DIS 1/2N BL PACK 32       8427370400612

Recambio Oto/Phenol      Refi II Oto/Phenol  
Recharge Oto/Phénol      Ricambio Oto/Phenol



REF. 40062      DIS 1/8N CS PACK 24       8427370400629

Comparador cloro + pH - pastillas DPD1      Test kit chlorine + pH - DPD1 tablets  
Trousse chlore + pH - pastilles DPD1      Kit analisi cloro + ph - pastiglie DPD1



REF. 40063      DIS 1/8 BL PACK 24       8427370400636

Recambio pastillas DPD1      Refi II DPD1 tablets  
Recharge pastilles DPD1      Ricarica pastiglie DPD1





# produits d'entretien [prodotti chimici]



REF. 40066

DIS 1/8 CS PACK 24

8427370400667

Kit de análisis de oxígeno/bromo + pH -  
pastillas DPD4

Oxygen / bromine + pH test kit - DPD4  
tablets

Trousse de oxygène/brome + pH pastilles  
DPD4

Kit analisi ossigeno/bromo + pH  
pastiglie DPD4



REF. 40067

DIS 1/8 BL PACK 24

8427370400674

Recambio pastillas DPD4

Refi il DPD4 tablets

Recharge pastilles DPD4

Ricarica pastiglie DPD4

## TIRAS DE ANÁLISIS TEST STRIPS LANGUETTES D'ANALYSE CARTINE TORNASOLE



REF. 40068

1/8 BL PACK 16

8427370400681

Análisis cloro + pH + alcalinidad  
(50 tiras).

Chlorine + pH + alkalinity analysis  
(50 strips).

Analyse chlore + pH + alcalinité  
(50 languettes).

Analisi cloro + pH + alcalinità  
(50 strisce).



REF. 40069

BX PACK 12

8427370400698

Analiza el nivel de sal en agua  
(16 tiras).

Salt level in water analysis  
(16 strips).

Analyse le niveau de Sel de l'eau  
(16 languettes).

Analizza il livello di sale nell'acqua  
(16 strisce).

# material plv pos material matériels plv materiale pos



TOTEMS



FOLLETOS LEAFLETS DÉPLIANTS VOLANTINI



DVDs

www.gre.es



Nos reservamos el derecho de cambiar total o parcialmente las características de nuestros artículos o el contenido de este documento sin previo aviso. Fotos e imágenes no contractuales.

We reserve the right to change all or part of the articles or contents of this document without prior notice. Photos and pictures are not contractual.

Nous nous réservons le droit de modifier totalment ou en partie les caractéristiques de nos articles ou le contenu de ce document sans préavis. Photos et images non contractuelles.

Ci riserviamo il diritto di cambiare totalmente o parzialmente le caratteristiche tecniche dei nostri prodotti ed il contenuto di questo documento senza nessun preavviso. La Fotografia o il disegno è solo a scopo illustrativo ed informativo.



**[www.gre.es](http://www.gre.es)**

Manufacturas GRE S.A. | Aritz Bidea nº 57 | Belako Industrialdea | Apartado 69 | 48100 Mungia (Vizcaya) Spain  
Tel. (34) 946 741 116 | Fax (34) 946 741 708 | [gre@gre.es](mailto:gre@gre.es)

